

Edelstahl | Messing | Aluminium | Profilgarnituren
Iron | Holz | Spannsysteme | Vitragen | Zubehör

Vorhanggarnituren Rundstangen



FLIX Firmenzentrale Strasshof

Flix Karniesen und Sonnenschutz GmbH & Co KG

Zentrale

A-2231 Strasshof, Hauptstraße 16
Telefon: 02287-3407-0
Fax: 02287-3407-20

Geschäftszeiten:
Mo-Do: 06.45 - 16.15
Fr: 06.45 - 12.00

Filiale

A-1080 Wien, Florianigasse 44
Telefon: 01-402 07 07
Fax: 01-405 70 90

Geschäftszeiten:
Mo-Mi: 07.30 - 12.00 & 12.45 - 17.00
Do: 07.30 - 12.00 & 12.45 - 17.30
Fr: 07.30 - 12.00

Kontakt

Buchhaltung: 02287-3407-12
Ausmesstermine: 02287-3407-15
Montagetermine: 02287-3407-15
Geschäftsleitung: 02287-3407-11

Bestellungen gerne unter:

Telefon: 02287-3407-13
02287-3407-14
Fax: 02287-3407-20
E-Mail: office@flix.at

Internet: www.flix.at

E-Mail: office@flix.at



Produktübersicht

Inhaltsverzeichnis

Inhalt

Farben & Oberflächen

Garnituren aus Metall	P 4
Garnituren aus Holz	P 5

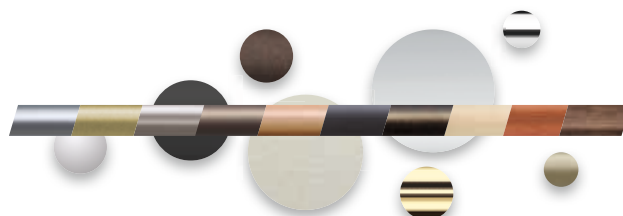

1 Edelstahl

	Katalog Seite	Übersicht Seite
Ø12 mm	3	P 6
Ø16 mm	13	P 7
Ø20 mm	31	P 8
Ø28 mm	57	P 9

2 Messing

Ø16 mm	75	P 10
Ø20 mm	91	P 11
Ø28 mm	127	P 12

3 Aluminium

Ø20 mm	165	P 13
Ø28 mm	187	P 14

4 Profil 20-34mm

Rund 20x20 mm	211	P 15
Eckig 20x20 mm	211	P 15
Quadrat 20x20 mm	215	P 15
Eckig 34x14 mm	225	P 15

5 Profil 40-70mm

Rechteck 40x15 mm	231	P 16
Oval 40x22 mm	243	P 16
Oval 70x22 mm	253	P 16
C-Profil 70 mm	263	P 16
V-Profil 70 mm	267	P 16
Blendsystem Flach 60 mm	271	P 16

6 Iron

	Katalog Seite	Übersicht Seite
Iron Design Ø20 mm	279	P 17
Iron Style Ø20 mm	295	P 18
Iron Design Ø28mm	313	P 19

7 Holz

Holzgarnituren Ø20 mm	329	P 20
Holzgarnituren Ø28 mm	339	P 20

8 Spannsysteme

Spannsysteme	349	P 21
--------------------	-----	------

9 Vitragen

Vitragen	359	P 22
----------------	-----	------

10 Einzelteile

Allgemeines Zubehör	367	P 23
Reinigung/Pflegehinweise	384	
Materialhinweise	P 24	

Farben & Oberflächen

Edelstahl-, Messing-, Aluminiumgarnituren, Profilharnituren, Iron Design, Iron Style, Seilspanngarnituren



aluminium
Farbcode: a



aluminium matt
Farbcode: am



edelstahl
Farbcode: e



verchromt
Farbcode: v



poliert lackiert
Farbcode: p



messing matt
Farbcode: m



nickel matt
Farbcode: n



weiß
Farbcode: w



schwarz
Farbcode: sw



bronze matt
Farbcode: bm



schwarz matt
Farbcode: sm

Holzdekorfarben für IL-Profile Ø20/Ø28



buche
Farbcode: bu



wildeiche
Farbcode: wi



zwetschke
Farbcode: zw



weiß struktur
Farbcode: ws



schwarz struktur
Farbcode: ss

Zusatzfarben Rechteck 40x15mm



palladium gebürstet
Farbcode: pg



gold gebürstet
Farbcode: gg

Zusatzfarben Rund/Eckig 20x20mm



messing matt
Farbcode: mm



scotch/bright
Farbcode: sb

Iron Design



rost
Farbcode: ro



anthrazit
Farbcode: at

Iron Style Ø20mm



rostbraun
Farbcode: rb



weiß/gold
Farbcode: wg



schwarz
Farbcode: sw

Lieferbare Farben für ein Modell können Sie dem jeweiligen Produktblatt entnehmen.

Farben & Oberflächen

Holzgarnituren



natur

Farbcode: na



buche hell

Farbcode: bu



kirschbaum

Farbcode: kr



nussbaum

Farbcode: nu



weiß

Farbcode: we



schwarz

Farbcode: sw

Lieferbare Farben für ein Modell können Sie dem jeweiligen Produktblatt entnehmen.

Ø12

Edelstahl Ø12mm - Trägersystem



Offene Wandträger Rund

Seite 9

Farben Zubehör & Stangen



Edelstahl Ø12mm - Endknöpfe

Piko



Seite 5

Corinna



Seite 5

Sabine



Seite 5

Ø16

Rohr Maßstab 1:1

Edelstahl Ø16mm - Trägersysteme



Innenlauf-Wandträger

Seite 23

Farben Zubehör & Stangen

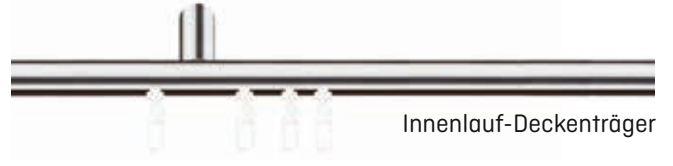

Innenlauf-Deckenträger

Seite 23

Farben Zubehör & Stangen



Offene Wandträger Rund

Seite 27

Farben Zubehör & Stangen

Edelstahl Ø16mm - Endknöpfe

Anna flächenbündig



Seite 15

Theo flächenbündig



Seite 15

Sabine



Seite 15

Bozen



Seite 17

Modica



Seite 17

Siena



Seite 17

Varese



Seite 19

Lecce



Seite 19

Ø20

Edelstahl Ø20mm - Trägersysteme

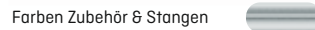
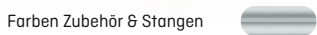
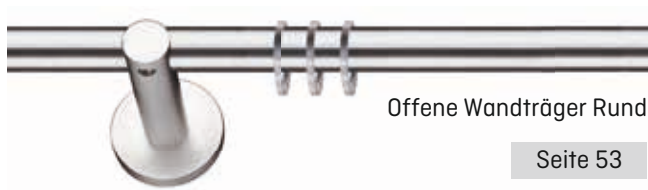

Edelstahl Ø20mm - Endknöpfe

<p>Anna flächenbündig</p> <p>Seite 33</p>	<p>Finn flächenbündig</p> <p>Seite 33</p>	<p>Theo flächenbündig</p> <p>Seite 33</p>	<p>Hestia flächenbündig</p> <p>Seite 35</p>	<p>Apollon flächenbündig</p> <p>Seite 35</p>	<p>Termoli flächenbündig</p> <p>Seite 35</p>
<p>Olymp flächenbündig</p> <p>Seite 37</p>	<p>Pan</p> <p>Seite 37</p>	<p>Sabine</p> <p>Seite 37</p>	<p>Padua</p> <p>Seite 39</p>	<p>Catania</p> <p>Seite 39</p>	<p>Fenja</p> <p>Seite 39</p>
<p>Modica</p> <p>Seite 41</p>	<p>Siena</p> <p>Seite 41</p>				

Rohr-/Innenlauf-Profil Maßstab 1:1

Ø28

Edelstahl Ø28mm - Trägersysteme



Innenlauf-Wandträger

Seite 65

Farben Zubehör



Farben Stangen



Innenlauf-Deckenträger

Seite 65

Farben Zubehör



Farben Stangen



Geschlossene Wandträger Glatt

Seite 69

Farben Zubehör & Stangen

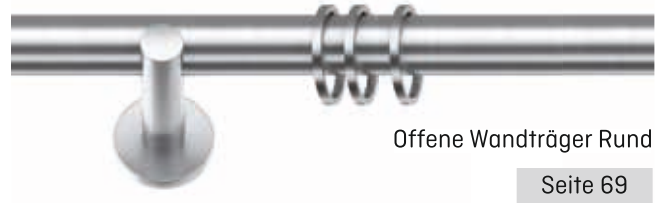

Offene Wandträger Rund

Seite 69

Farben Zubehör & Stangen



Edelstahl Ø28mm - Endknöpfe

Anna flächenbündig

Seite 59

Pan flächenbündig

Seite 59

Themis flächenbündig

Seite 59

Marsala

Seite 61

Firenze flächenbündig

Seite 61

Rohr-/Innenlauf-Profil Maßstab 1:1

Ø16

Messing Ø16mm - Trägersysteme

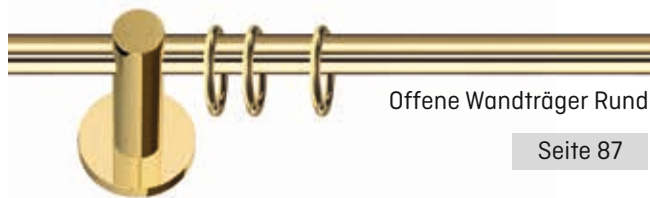
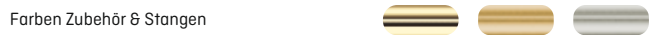
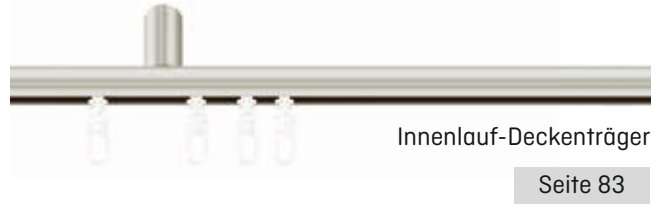

Messing Ø16mm - Endknöpfe



Rohr/Innenlauf-Profil Maßstab 1:1

Ø20

Rohr/Innenlauf-Profil Maßstab 1:1

Messing Ø20mm - Trägersysteme

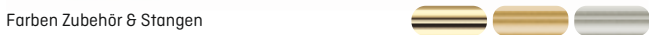
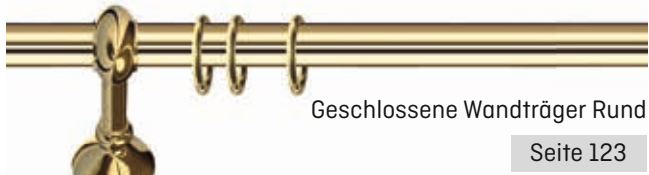
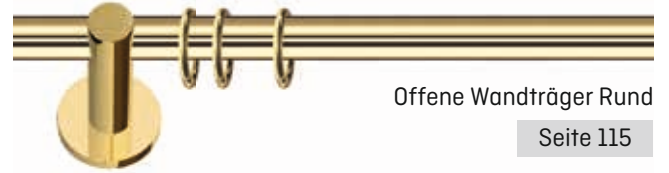
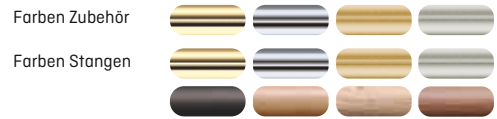
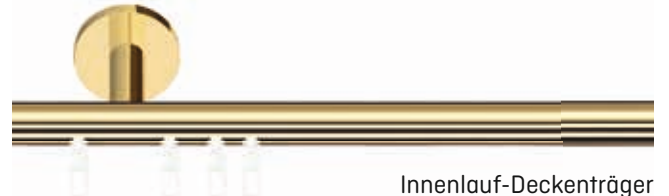
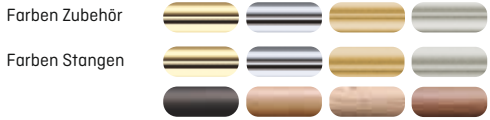

Messing Ø20mm - Endknöpfe

<p>Anna flächenbündig</p> <p>Seite 93</p>	<p>Olymp flächenbündig</p> <p>Seite 93</p>	<p>Thor flächenbündig</p> <p>Seite 93</p>	<p>Strass</p> <p>Seite 95</p>	<p>Apollon flächenbündig</p> <p>Seite 95</p>	<p>Imperia</p> <p>Seite 97</p>
<p>Katja</p> <p>Seite 97</p>	<p>Alassio</p> <p>Seite 97</p>	<p>Cremona</p> <p>Seite 99</p>	<p>Lisa</p> <p>Seite 99</p>	<p>Sabine</p> <p>Seite 99</p>	

Ø28

Messing Ø28mm - Trägersysteme

Rohr/Innenlauf-Profil Maßstab 1:1



Innenlauf-Wandträger
Seite 143

Farben Zubehör: 

Farben Stangen: 

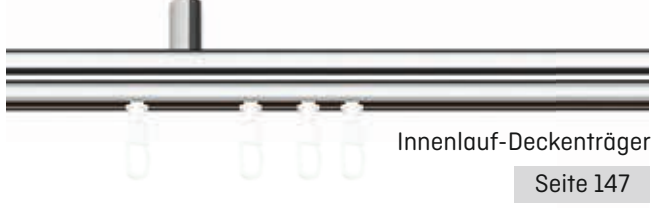

Innenlauf-Deckenträger
Seite 147

Farben Zubehör: 

Farben Stangen: 

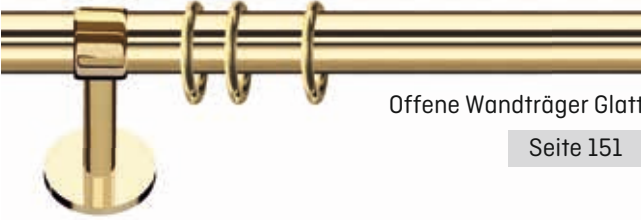

Offene Wandträger Glatt
Seite 151

Farben Zubehör & Stangen: 



Offene Wandträger Glatt
Storeschiene mit Alu Innenlauf-Profil
Seite 155



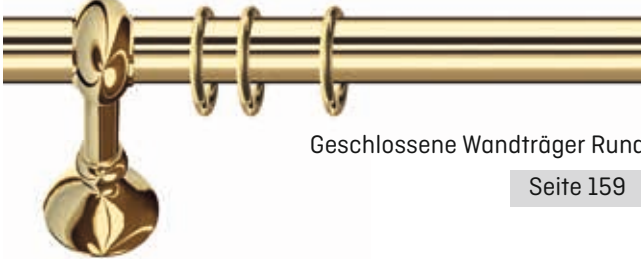













Farben Zubehör & Stangen: 



Geschlossene Wandträger Rund
Seite 159

Farben Zubehör & Stangen: 

Messing Ø28mm - Endknöpfe

<p>Olymp flächenbündig</p>  <p>Seite 129</p>	<p>Anna flächenbündig</p>  <p>Seite 129</p>	<p>Sabine</p>  <p>Seite 129</p>	<p>Pescara</p>  <p>Seite 131</p>	<p>Bologna</p>  <p>Seite 131</p>	<p>Perosa</p>  <p>Seite 131</p>
<p>Alassio</p>  <p>Seite 133</p>	<p>Cremona</p>  <p>Seite 133</p>	<p>Köln</p>  <p>Seite 133</p>	<p>Lava flächenbündig</p>  <p>Seite 135</p>	<p>Napoli</p>  <p>Seite 135</p>	<p>Verona</p>  <p>Seite 135</p>
<p>Wien</p>  <p>Seite 137</p>	<p>Paris</p>  <p>Seite 137</p>	<p>Milano</p>  <p>Seite 137</p>	<p>Strass</p>  <p>Seite 139</p>		

Ø20

Rohr/Innenlauf-Profil Maßstab 1:1

Aluminium Ø20 mm - Trägersysteme



Farben Zubehör

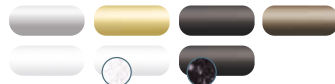

Farben Stangen

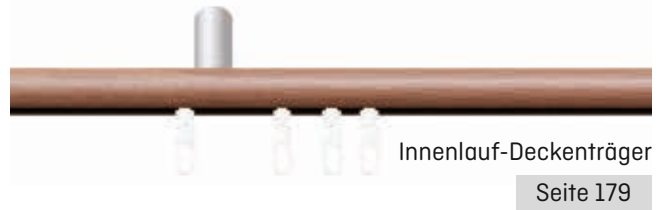
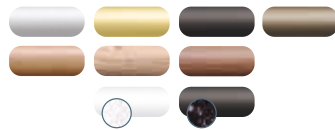

Farben Zubehör

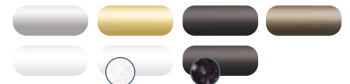

Farben Stangen

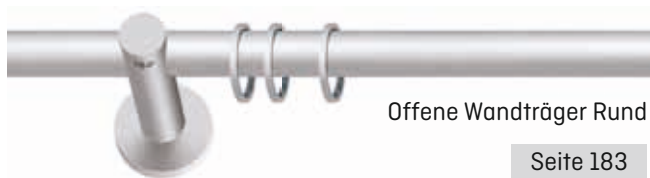
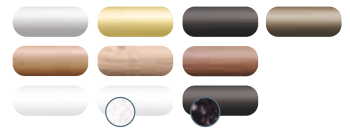

Farben Zubehör & Stangen



Farben Zubehör & Stangen



Aluminium Ø20 mm - Endknöpfe



Ø28

Aluminium Ø28 mm - Trägersysteme

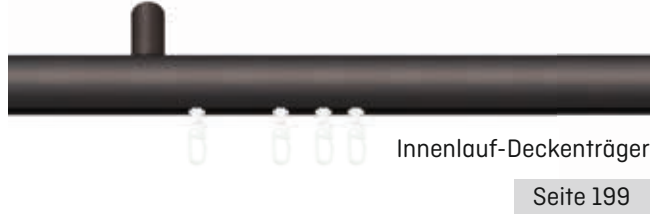

Aluminium Ø28 mm - Endknöpfe

<p>Pan flächenbündig</p> <p>Seite 189</p>	<p>Anna flächenbündig</p> <p>Seite 189</p>	<p>Themis flächenbündig</p> <p>Seite 189</p>	<p>Firenze flächenbündig</p> <p>Seite 191</p>	<p>Marsala</p> <p>Seite 191</p>
---	--	--	---	---------------------------------

Rohr/Innenlauf-Profil Maßstab 1:1

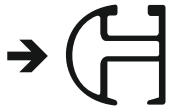

Rund 20x20 mm

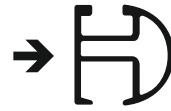
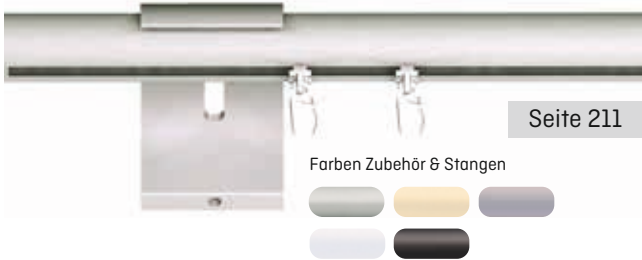

Eckig 20x20 mm

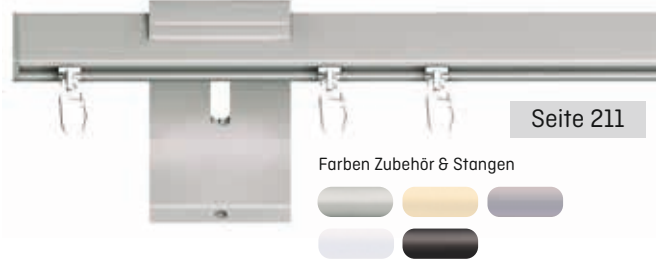

Quadrat 20x20 mm

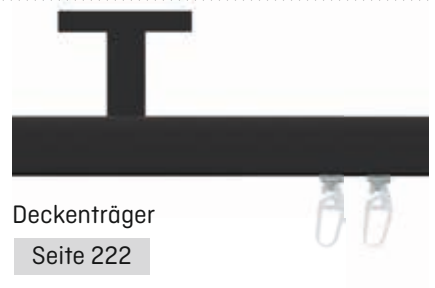

Quadrat 20x20 mm - Endknöpfe

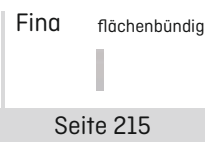

Eckig 34x14 mm



Rechteck 40x15 mm



Wandträger Seite 233



Multi-Wandträger Seite 236



Deckenträger Seite 238

Rechteck 40x15 mm - Endknöpfe

Valerie flächenbündig



Seite 231

Mirella flächenbündig



Seite 231

Farben Stangen & Zubehör

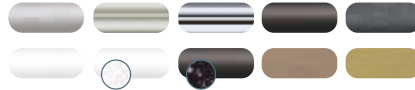

Oval 40x22 mm



Wandträger Seite 246



Multi-Wandträger Seite 248

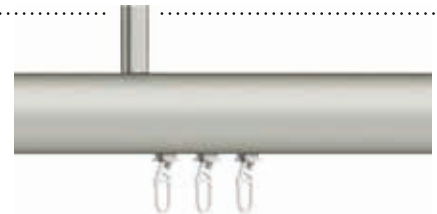

Deckenträger Seite 250

Oval 40x22 mm - Endknöpfe

Melissa flächenbündig



Seite 243

Tamara flächenbündig



Seite 243

Farben Stangen & Zubehör



Oval 70x22 mm

Farben Stangen & Zubehör

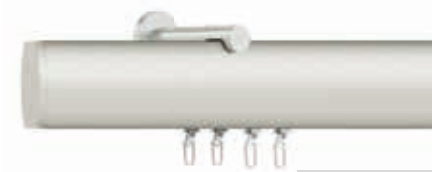

Wandträger Seite 254



Multi-Wandträger Seite 256



Deckenträger Seite 258

C-Profil/V-Profil 70 mm



C-Profil 70x57mm

Seite 263

Farben Stangen & Zubehör



V-Profil 70x57mm

Seite 267

Farben Stangen & Zubehör



Blendsystem Flach 60 mm



Multi-Wandträger

Seite 272

Farben Stangen & Zubehör



Deckenträger

Seite 274

Farben Stangen & Zubehör



Ø20

Rohr/Innenlauf-Profil Maßstab 1:1

Iron Design Ø20 mm - Trägersysteme

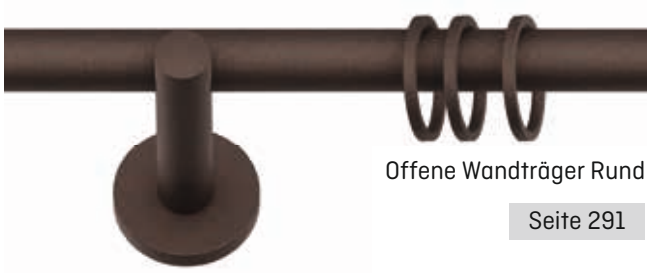
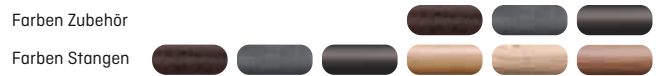
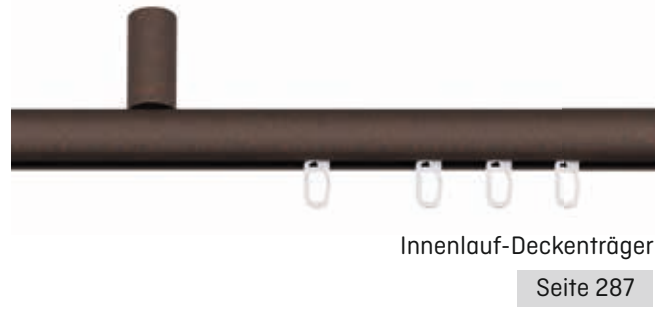
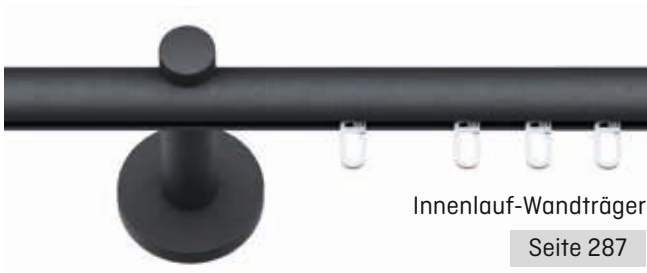

Iron Design Ø20 mm - Endknöpfe



Ø20

Iron Style Ø20 mm - Trägersysteme



Farben Zubehör & Stangen

Farben Zubehör & Stangen

Iron Style Ø20 mm - Endknöpfe

<p>Leon</p> <p>Seite 297</p>	<p>Burgos</p> <p>Seite 297</p>	<p>Merida</p> <p>Seite 297</p>	<p>Reus</p> <p>Seite 299</p>	<p>Parla</p> <p>Seite 299</p>	<p>Calella</p> <p>Seite 299</p>
<p>Almeria</p> <p>Seite 301</p>	<p>Cordoba</p> <p>Seite 301</p>	<p>Gandia</p> <p>Seite 301</p>	<p>Cadiz</p> <p>Seite 301</p>		

Rohr Maßstab 1:1

Ø28

Iron Design Ø28 mm - Trägersysteme



Innenlauf-Wandträger

Seite 319

Farben Zubehör

Farben Stangen



Innenlauf-Deckenträger

Seite 319

Farben Zubehör

Farben Stangen

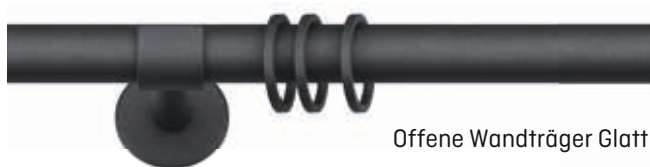

Offene Wandträger Glatt

Seite 323

Farben Zubehör & Stangen



Iron Design Ø28 mm - Endknöpfe



Seite 315



Seite 315



Seite 315



Seite 315

Ø20

Holzgarnituren Ø20 mm



Konische Wandträger

Seite 331

Farben Zubehör & Stangen



Geschlossene Wandträger

Seite 335

Farben Zubehör & Stangen

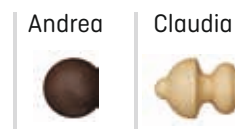

Ø28

Holzgarnituren Ø28 mm



Geschlossene Wandträger

Seite 341

Farben Zubehör & Stangen

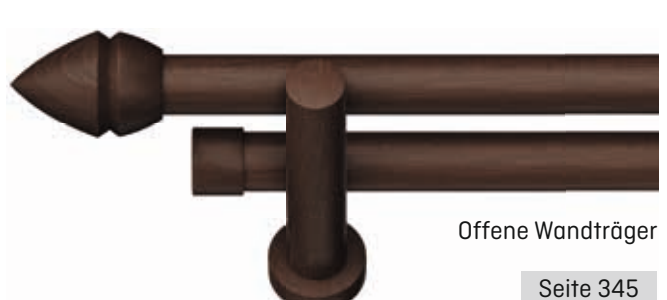

Offene Wandträger

Seite 345

Farben Zubehör & Stangen



mit Ø5 mm Spannstange



nickel matt

Cortina

Seite 351

Farben:

mit Ø2 mm Spannseil



nickel matt

Cortina

Seite 351

Farben:

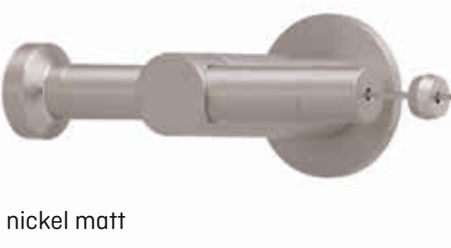

nickel matt

Avellino

Seite 355

Farben:

Ø7-13

Vitragenstangen

Angela

Ø7-9mm
ausziehbar

Seite 362

Eveline

6x11mm
ausziehbar

Seite 362

Nadine

Ø7mm
ausziehbar

Seite 363

Barbara

Reinmessing

Ø10mm
ausziehbar

Seite 363

Alexandra

Reinmessing

Ø10mm



Seite 364

Swarovski

Reinmessing mit Swarovski-Kristall

Ø10mm



Seite 364

Sylvia

Ø12mm
ausziehbar

Seite 365

Sydney

Reinmessing

Ø13mm



Seite 366

Malta

Reinmessing

Ø13mm



Seite 366

Allgemeines Zubehör



Faltenleghaken

Seite 369



Gleiter, Laufroller, Gardinenhaken

Seite 369



Ringe

Seite 371



Raffrosetten, Raffknöpfe und Verlängerungen

Seite 373



Abstandhalter, Raffhalter

Seite 374



Stangen, Rohre, Innenlauf-Profile, Profilverbinder

Seite 375



Schleuderstäbe

Seite 377



Storeschienen

Seite 378



Biegungen

Seite 379



Erker ausmessaanleitung

Seite 381

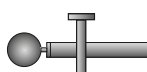

Bestellhilfe

Seite 383



Reinigung/Pflegehinweise

Seite 384

Material und Oberflächen

Edelstahl

Bei Garnituren aus Edelstahl werden sämtliche Bestandteile wie zb. Endknöpfe, Ringe, Endkappen und Rohre aus Echt-Edelstahl V2A gefertigt, welche anschließend einer Oberflächenbehandlung unterzogen werden. Ausnahmen sind hier zb. Innenlaufprofile, welche aus Aluminium gefertigt und passend oberflächenbehandelt werden, sowie Kleinteile wie zb. Madenschrauben und Befestigungsmaterial die aus Metall oder Kunststoff bestehen.

Aluminium

Bei Garnituren aus Aluminium werden sämtliche Bestandteile wie zb. Endknöpfe, Ringe, Endkappen und Rohre, Innenlauf Profile aus einer Aluminiumlegierung gefertigt, welche anschließend einer Oberflächenbehandlung unterzogen werden. Ausnahmen sind hier Kleinteile wie zb. Madenschrauben und Befestigungsmaterial, diese bestehen aus Metall oder Kunststoff.

Aluminium Garnituren sind in folgenden Oberflächen erhältlich:

aluminium:	Eloxal - E6/EV1
gold matt:	Eloxal - E6/EV3
bronze matt:	Eloxal - E6/C33
schwarz matt:	Eloxal - E6/C35
anthrazit:	lackiert in Strukturfarbe
rost:	lackiert zweifarbig in Strukturfarbe
aluminium matt:	mattiert und einbrennlackiert

Messing

Bei Garnituren aus Messing werden sämtliche Bestandteile wie zb. Endknöpfe, Ringe, Endkappen und Rohre aus Reinmessing gefertigt, welche anschließend einer Oberflächenbehandlung unterzogen werden. Ausnahmen sind hier zb. Innenlaufprofile, welche aus Aluminium gefertigt und passend oberflächenbehandelt werden. Kleinteile wie zb. Madenschrauben und Befestigungsmaterial bestehen aus Metall oder Kunststoff.

Messing Garnituren sind in folgenden Oberflächen erhältlich:

poliert lackiert:	Bestandteile werden poliert und anschließend einbrennlackiert.
messing matt:	Bestandteile werden mittels Schleifmittel mattiert und anschließend einbrennlackiert
verchromt:	Bestandteile werden galvanisch verchromt
nickel matt:	Bestandteile werden galvanisch vernickelt, mittels Schleifmittel mattiert und einbrennlackiert

Holz

Bei Garnituren aus Holz werden sämtliche Bestandteile wie zb. Endknöpfe, Ringe, Endkappen und Stangen aus Holz gefertigt, welche anschließend gebeizt und lackiert oder farbig lackiert werden.



FLIX Karniesen und Sonnenschutz GmbH & Co KG

Zentrale:

Hauptstraße 16, 2231 Strasshof
Telefon: 02287 / 34 07, Fax: 02287 / 34 07 - 20
E-Mail: office@flix.at
www.flix.at

Filiale Wien:

Florianigasse 44, 1080 Wien
Telefon: 01 / 402 07 07, Fax: 01 / 405 70 90



Edelstahl

Edelstahl Ø12 mm

Übersicht	Seite 4
Endknöpfe	Seite 5
Offene Wandträger Rund	Seite 9

Edelstahl Ø16 mm

Übersicht	Seite 14
Endknöpfe	Seite 15
Innenlauf-Wandträger	Seite 23
Innenlauf-Deckenträger	Seite 23
Offene Wandträger Rund	Seite 27

Edelstahl Ø20 mm

Übersicht	Seite 32
Endknöpfe	Seite 33
Innenlauf-Wandträger	Seite 45
Innenlauf-Deckenträger	Seite 49
Geschlossene Wandträger Glatt	Seite 53
Offene Wandträger Rund	Seite 53
Offene Wandträger Rund, Storeschiene mit Alu-Innenlauf-Profil	Seite 53

Edelstahl Ø28 mm

Übersicht	Seite 58
Endknöpfe	Seite 59
Innenlauf-Wandträger	Seite 65
Innenlauf-Deckenträger	Seite 65
Geschlossene Wandträger Glatt	Seite 69
Offene Wandträger Rund	Seite 69

flüX

Ø12

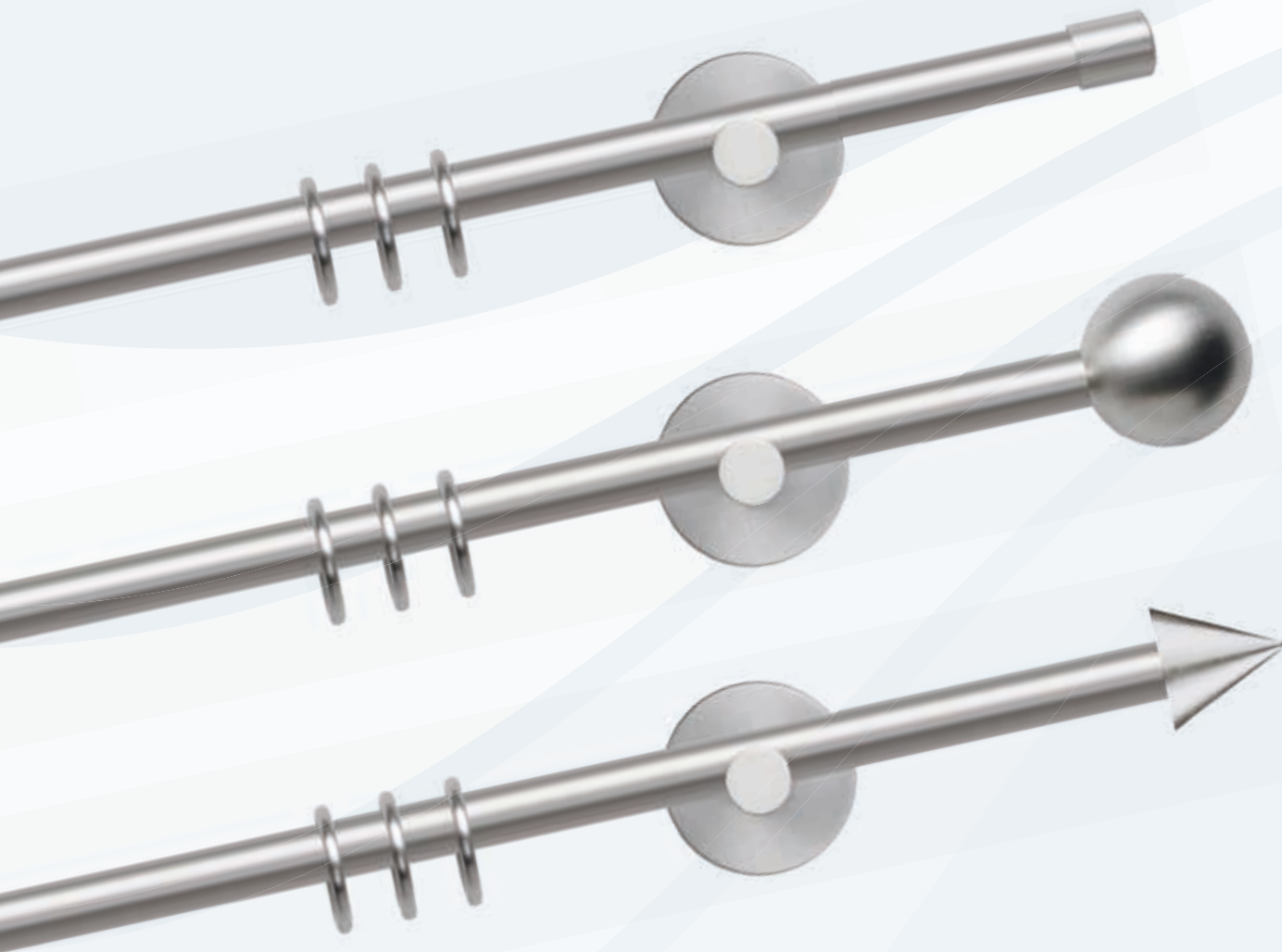

Edelstahl Ø12mm

Edelstahl Ø12mm - Trägersystem



Offene Wandträger Rund

Seite 9

Farben Zubehör & Stangen



Edelstahl Ø12mm - Endknöpfe

Piko



Seite 5

Corinna



Seite 5

Sabine



Seite 5



Ø12



Piko

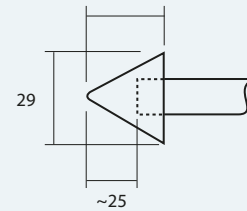

Corinna

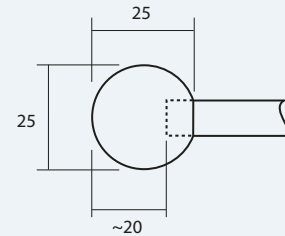

Sabine

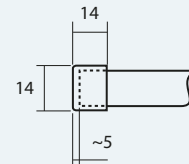

Endknöpfe Edelstahl Ø12 mm

Piko



edelstahl
Maßstab 1:1

Endknopf Piko		Stück
edelstahl	 836 612 e	25,50

Corinna



edelstahl
Maßstab 1:1

Endknopf Corinna		Stück
edelstahl	 836 512 e	25,50

Sabine



edelstahl
Maßstab 1:1

Endknopf Sabine		Stück
edelstahl	 830 012 e	25,50

Leichte Farbunterschiede zwischen Stange, Endknöpfen und Wandträger können aus produktionstechnischen Gründen auftreten.



Ø12



Edelstahl Ø12mm Trägersysteme

Edelstahl Ø12mm - Trägersystem



Offene Wandträger Rund

Farben Zubehör & Stangen



Seite 9

Erker Ausführung nicht möglich!



Biegung



Gehrung



Gelenk

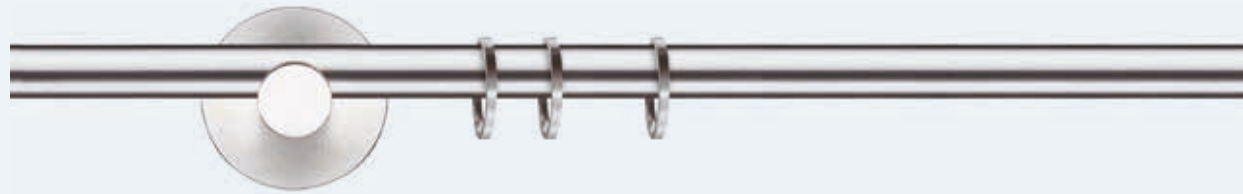

Farben Zubehör & Stangen



edelstahl

Offene Wandträger Rund

Garnituren mit Offenen Wandträgern Rund ohne Endknöpfe



edelstahl, mit Ringen
Maßstab 1:1



edelstahl, mit Ringen
Maßstab 1:1



edelstahl, mit Ringen
Maßstab 1:1

Lieferumfang

- ▶ **1 lfg:** 1 Edelstahl-Rohr Ø12mm oberflächenbehandelt, je nach Länge Wandträger und Ringe mit Faltenleghaken lt. Liste
- ▶ **2 lfg:** 2 Edelstahl-Rohre Ø12mm oberflächenbehandelt, je nach Länge Wandträger und Ringe mit Faltenleghaken lt. Liste, 2 Endkappen

- ▶ mit Montagematerial
- ▶ Bestellmaß = Rohrmaß
- ▶ Trägermitte bis Ringunterkante: 11 mm
- ▶ bei geänderter Ausführung Aufpreis bzw. Preisänderung
- ▶ **Aus produktionstechnischen Gründen bestehen geringfügige Farbabweichungen zwischen den Karniesenkomponenten.**

Trägermaße

Träger 1-läufig:

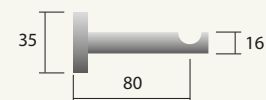

Träger 2-läufig:

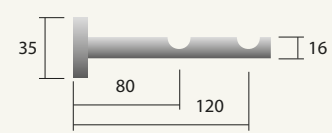

Maße in mm

			Edelstahl-Rohr	
Bestellcode:			t12-003	t12-004
Länge (cm)	Wand-träger	Ringe 1l./2l.	1lfg ○	2lfg ○○
100	2	14/28	121	193
120	2	16/32	131	289
140	2	20/40	141	373
160	3	22/44	185	289
180	3	24/48	195	308
200	3	28/56	205	327
220	3	30/60	215	346
240	3	34/68	225	365
260	3	36/72	235	384
280	3	38/76	245	403
300	3	42/84	255	422
320	4	44/88	295	473
340	4	48/96	305	492
360	4	50/100	315	511
380	4	52/104	325	530
400	4	56/112	335	549
+ 20cm	▲	3/6	10	19
Preisänderung bei Wandlager	1-seitig		-21,00	-19,50
	2-seitig		-42,00	-39,10

▲ ab einer Länge von ca. 440 cm bzw. bei schwereren Vorhängen wird ein weiterer Träger empfohlen (Aufpreis)

Träger kürzen: 19,-/Stück

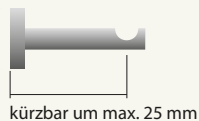
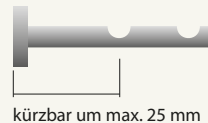
Träger
1-läufig:Träger
2-läufig:

Wandträger 1lfg - Wandabstand 80mm Stück

	edelstahl	815 112 e	42,90
---	-----------	-----------	-------

Flachring Ø20mm + FH Stück

	edelstahl	847 201 e	2,-
--	-----------	-----------	-----

Wandträger 2lfg - Wandabstand 80/120mm Stück

	edelstahl	815 512 e	50,70
---	-----------	-----------	-------

Faltenleghaken Stück

	Kunststoff glasklar	36003 gk	0,10
---	---------------------	----------	------

Trägerverlängerung 40mm Stück

	edelstahl	815 115 e	12,20
---	-----------	-----------	-------

Endkappe Ø12mm Stück

	edelstahl	830 012 e	25,50
---	-----------	-----------	-------

Wandlager Ø12mm Stück

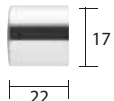
	edelstahl	82 5012 e	19,20
---	-----------	-----------	-------

Edelstahlrohr, Ø12mm, Stange 6m Meter

	edelstahl	es 1210	35,50
---	-----------	---------	-------



Edelstahl
Ø16

Ø16

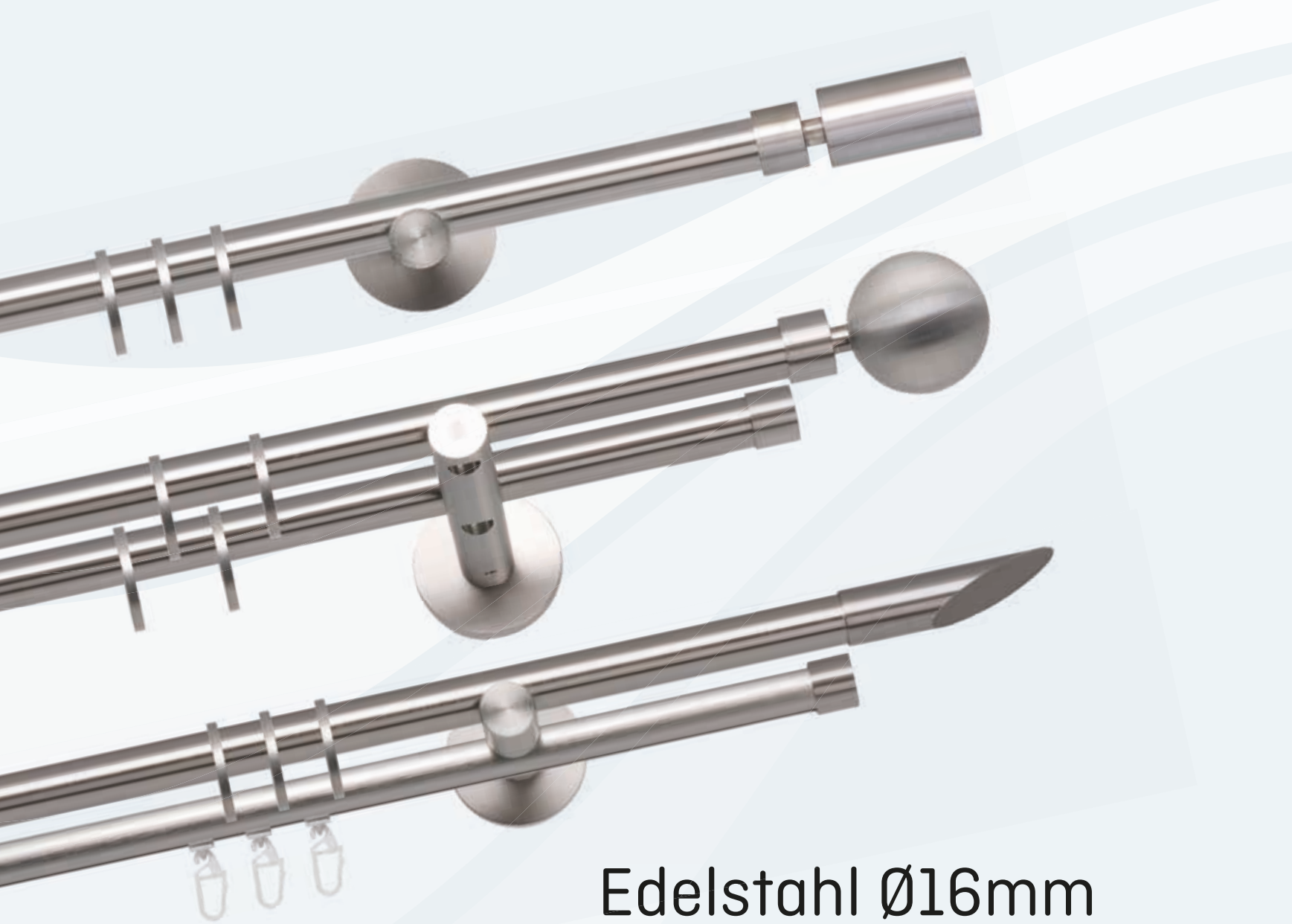

Edelstahl Ø16mm

Edelstahl Ø16mm - Trägersysteme

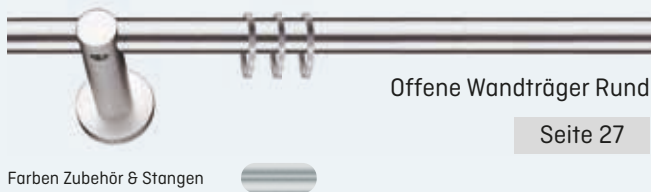

Edelstahl Ø16mm - Endknöpfe





Anna
FLÄCHENBÜNDIG

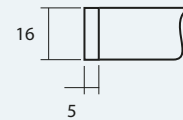

Theo
FLÄCHENBÜNDIG

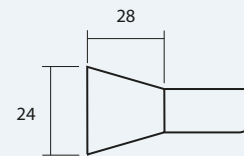

Sabine

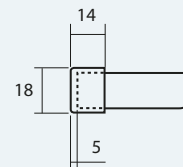

Endknöpfe Edelstahl Ø16 mm

Anna

FLÄCHENBÜNDIG



edelstahl
Maßstab 1:1

Endknopf Anna		Stück
edelstahl	831 416 e	21,-

Theo

FLÄCHENBÜNDIG



edelstahl
Maßstab 1:1

Endknopf Theo		Stück
edelstahl	831 816 e	31,20

Sabine



edelstahl
Maßstab 1:1

Endknopf Sabine		Stück
edelstahl	830 016 e	13,20

Leichte Farbunterschiede zwischen Stange, Endknöpfen und Wandträger können aus produktionstechnischen Gründen auftreten.



Bozen

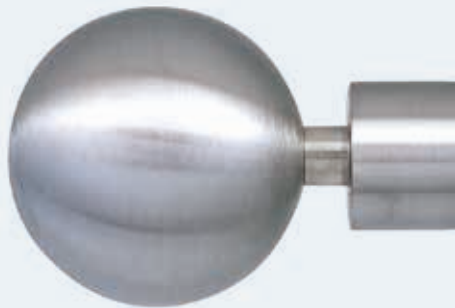
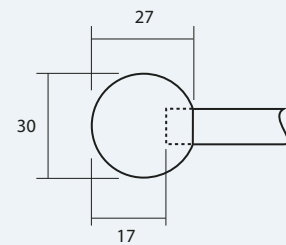

Modica

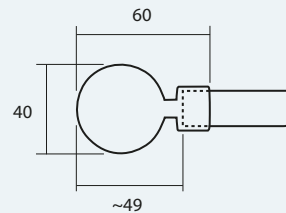

Siena

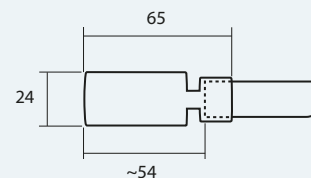

Endknöpfe Edelstahl Ø16 mm

Bozen



edelstahl
Maßstab 1:1

Endknopf Bozen		Stück
edelstahl	 832 016 e	22,80

Modica

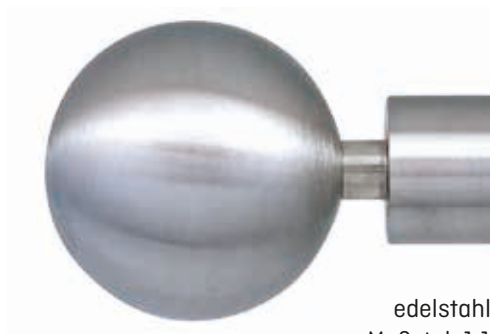

edelstahl
Maßstab 1:1

Endknopf Modica		Stück
edelstahl	 835 916 e	38,40

Siena

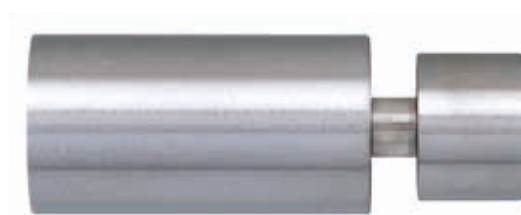

edelstahl
Maßstab 1:1

Endknopf Siena		Stück
edelstahl	 835 816 e	38,40

Leichte Farbunterschiede zwischen Stange, Endknöpfen und Wandträger können aus produktionstechnischen Gründen auftreten.



Varese

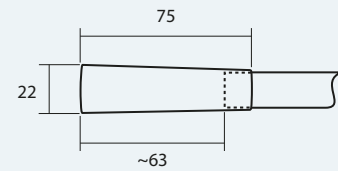

Lecce

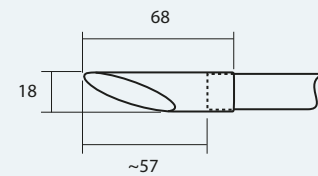

Endknöpfe Edelstahl Ø16 mm

Varese



edelstahl
Maßstab 1:1

Endknopf Varese		Stück
edelstahl	 835 616 e	22,80

Lecce



edelstahl
Maßstab 1:1

Endknopf Lecce		Stück
edelstahl	 834 816 e	22,80

Leichte Farbunterschiede zwischen Stange, Endknöpfen und Wandträger können aus produktionstechnischen Gründen auftreten.



Ø16

Edelstahl
Ø16

Träger-
systeme

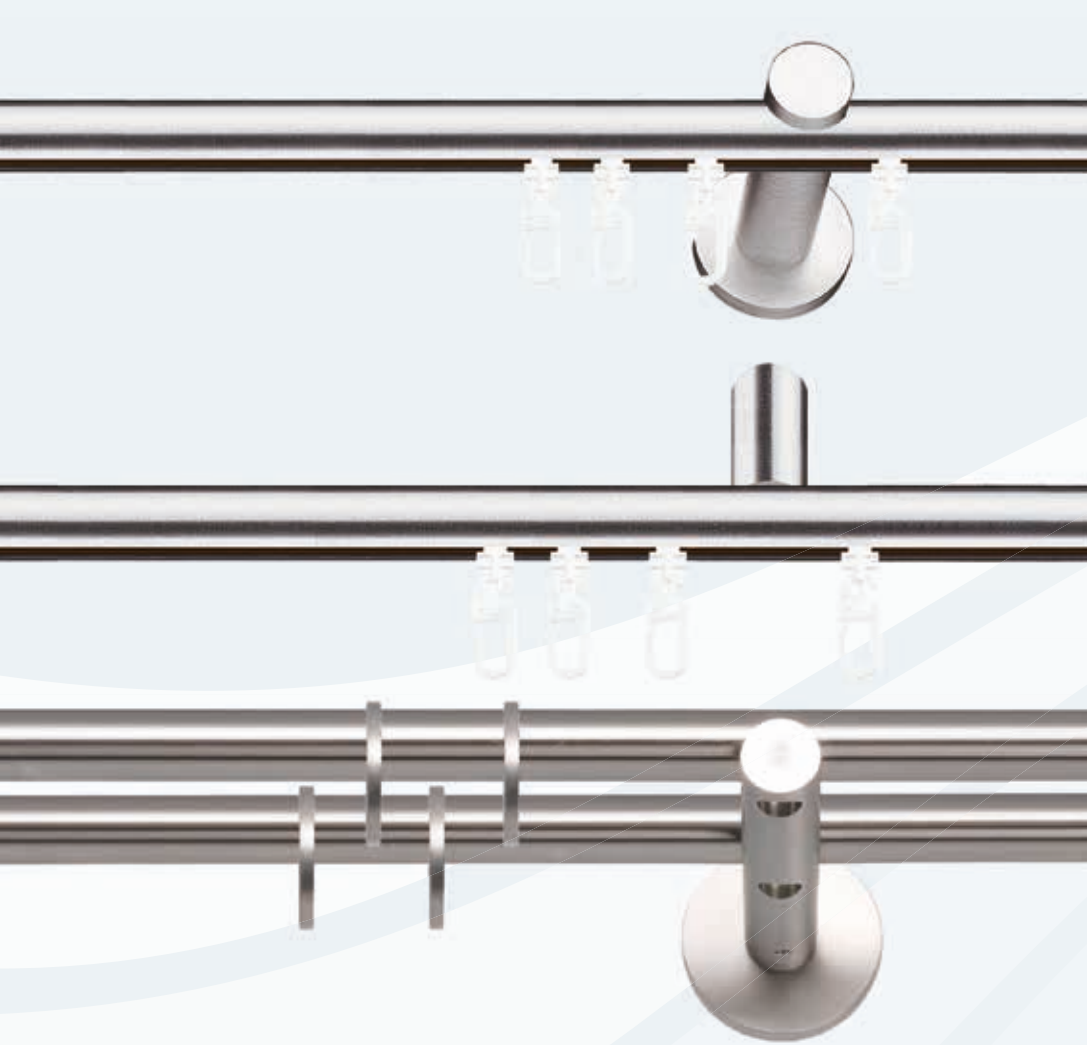

Edelstahl Ø16mm Trägersysteme

Edelstahl Ø16mm - Trägersysteme



Innenlauf-Wandträger

Seite 23

Farben Zubehör & Stangen 



Innenlauf-Deckenträger

Seite 23

Farben Zubehör & Stangen 



Offene Wandträger Rund

Seite 27

Farben Zubehör & Stangen 



EDELSTAHL

Ø16

Edelstahl
Ø16

Träger-
systeme



mit KLIXI
Drehgleiter

Erkerausführung



Biegung



Gehrung



Gelenk

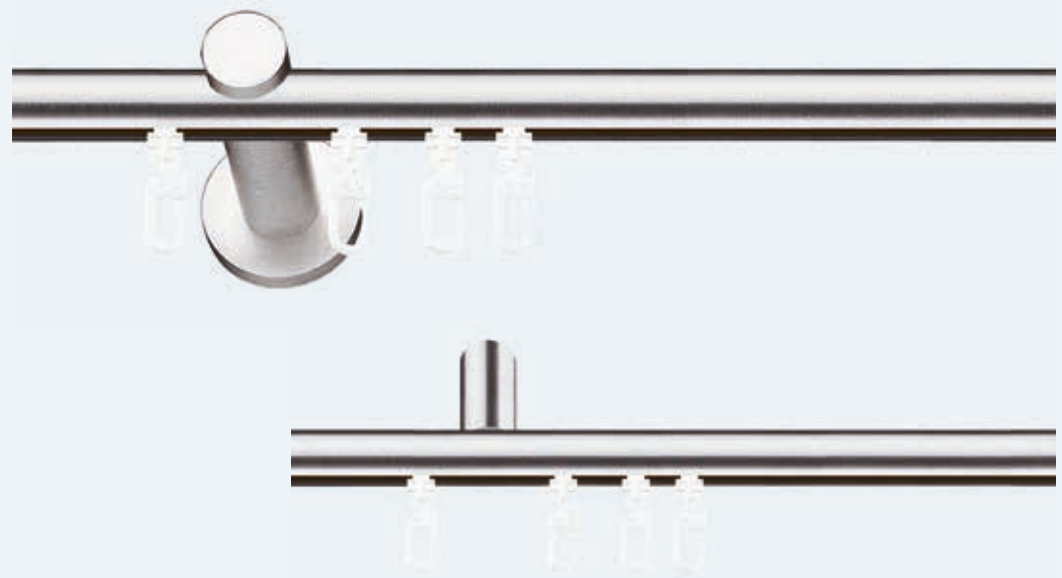

Farben Zubehör & Stangen



edelstahl

Innenlauf-Wandträger Innenlauf-Deckenträger

Garnituren mit Innenlaufträgern ohne Endknöpfe



edelstahl
Maßstab 1:1

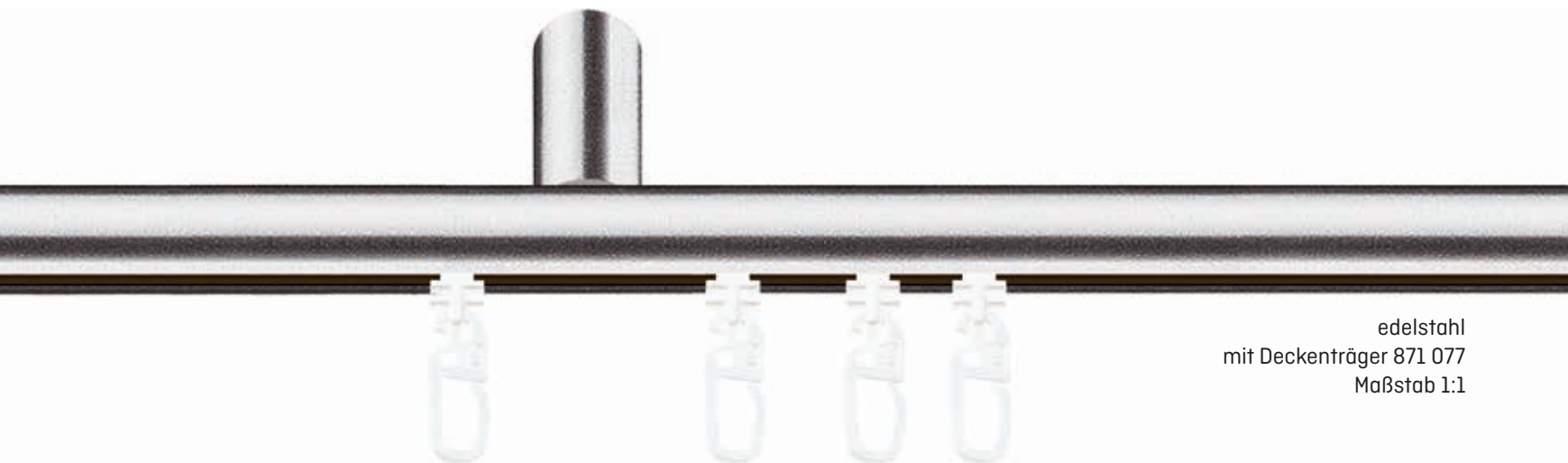

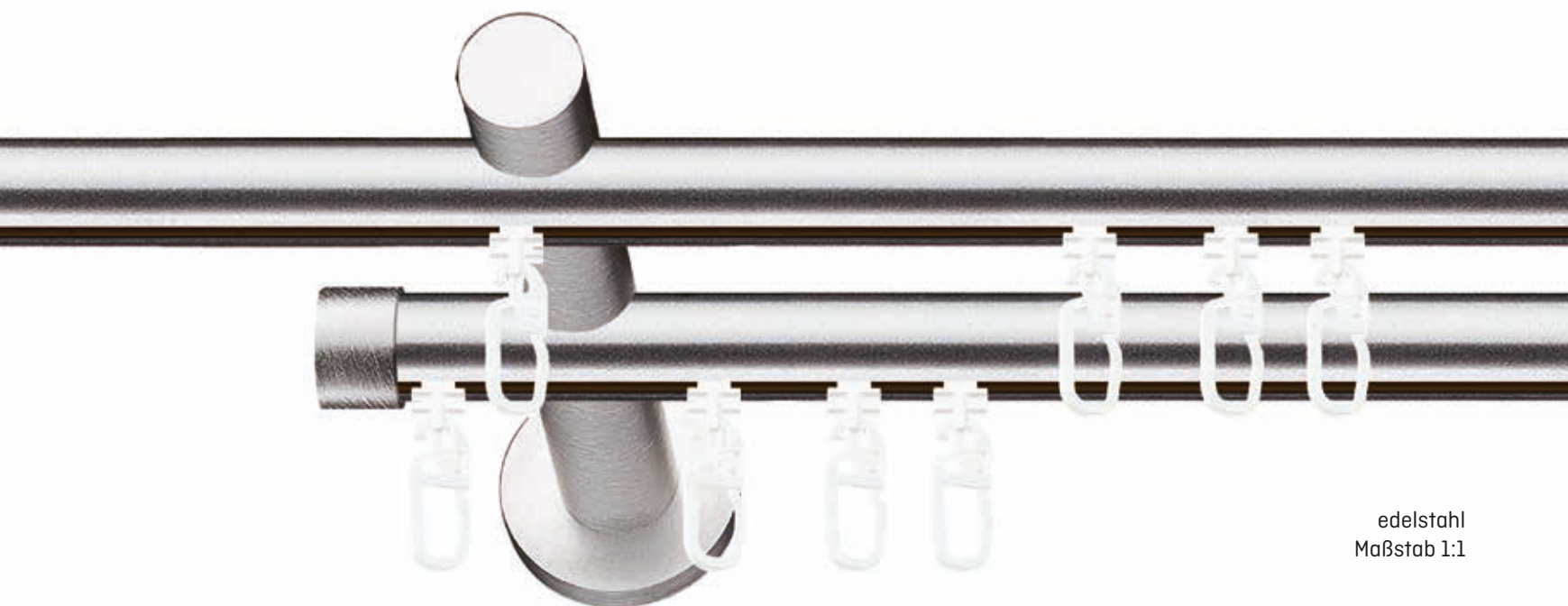

edelstahl
mit Deckenträger 871 077
Maßstab 1:1



edelstahl
Maßstab 1:1

Lieferumfang



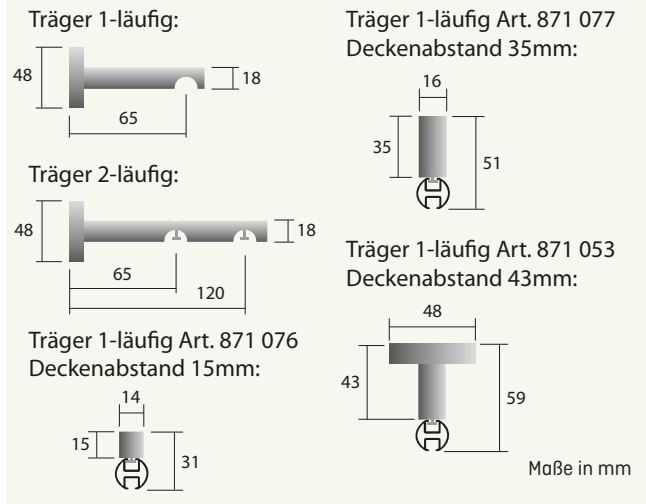

- ▶ **1 lfg:** 1 Alu Innenlauf-Profil Ø16mm oberflächenbehandelt, je nach Länge Wandträger und -Drehgleiter lt. Liste
- ▶ **2 lfg:** 2 Alu Innenlauf-Profile Ø16mm oberflächenbehandelt, je nach Länge Wandträger und -Drehgleiter lt. Liste, 2 Endkappen
- ▶ **1 lfg mit Deckenträger 15mm Deckenabstand**
- ▶ **1 lfg mit Deckenträger 35mm Deckenabstand**
- ▶ **1 lfg mit Deckenträger 43mm Deckenabstand**
- ▶ **Deckenträger:** 1 Alu Innenlauf-Profil Ø16mm oberflächenbehandelt, je nach Länge Deckenträger und -Drehgleiter lt. Liste

- ▶ mit Montagematerial
- ▶ Bestellmaß = Profilmaß
- ▶ Wandträger: Trägermitte bis Innenlaufprofil-Unterkante: 13mm
- ▶ Decke bis Innenlauf-Profilunterkante: siehe Maßskizzen
- ▶ bei geänderter Ausführung Aufpreis bzw. Preisänderung

Trägermaße







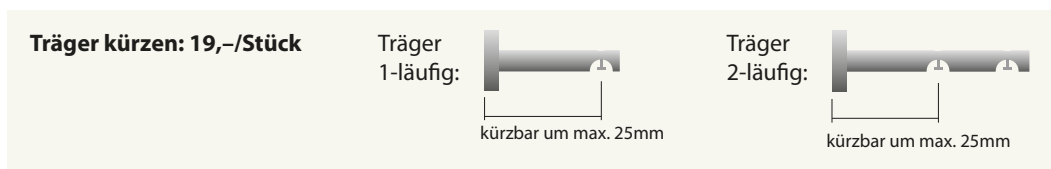

▶ **Aus produktionstechnischen Gründen bestehen geringfügige Farbabweichungen zwischen den Karniesenkomponenten.**

			edelstahl				
			Wandträger		Deckenträger		
Bestellcode:			t16-001	t16-002	t16-301	t16-302	t16-303
Länge (cm)	Wand-träger	Gleiter 1l./2l.	1lfg 	2lfg 	1lfg 	1lfg 	1lfg 
100	2	16/32	101	183	75	80	108
120	2	18/36	107	196	81	86	114
140	2	22/44	113	209	87	92	120
160	2	26/52	119	222	93	98	126
180	3	28/54	161	281	122	129	129
200	3	32/64	167	294	128	135	135
220	3	34/68	173	307	134	141	141
240	3	38/76	179	320	140	147	147
260	3	42/84	185	333	146	153	153
280	3	44/88	191	346	152	159	159
300	3	48/96	197	359	158	165	165
320	3	50/100	203	372	164	171	171
340	3	54/108	209	385	170	177	177
360	4	58/116	253	441	200	210	267
380	4	60/120	259	454	206	216	273
400	4	64/128	265	467	212	222	279
+ 20 cm ▲		3/6	6	13	6	6	6
Preisänderung bei Wandlager	1-seitig		+2,20	+13,90			
	2-seitig		+4,30	+27,80			

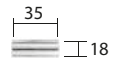
▲ ab einer Länge von ca. 500 cm bzw. bei schwereren Vorhängen wird ein weiterer Träger empfohlen (Aufpreis)

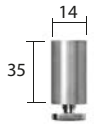

Träger und passende Verlängerungen			
Wandträger 1lfg - Wandabstand 65mm			
	edelstahl	871 072 e	34,80
Wandträger 2lfg - Wandabstand 65/120mm			
	edelstahl	871 074 e	46,80
Trägerverlängerung 35mm			
	edelstahl	871 043 e	15,60

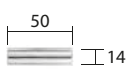
Träger und passende Verlängerungen			
Deckenträger, Deckenabstand 15mm			
	edelstahl	871 076 e	21,60
Deckenträger, Deckenabstand 35mm			
	edelstahl	871 077 e	24,-
Deckenträger 1lfg., Deckenabstand 43mm/Ø14mm			
	edelstahl	871 053 e	34,80
Trägerverlängerung 50mm			
	edelstahl	810 735 e	16,80

Deckenträger kürzbar - Deckenabstand 42-500mm			
	edelstahl	871 084 e	57,60
Endkappe Ø16mm			
	edelstahl	830 016 e	13,20
Endkappe flächenbündig Anna Ø16mm			
	edelstahl	831 416 e	21,-
Wandlager Ø16mm			
	edelstahl	82 316 e	33,60

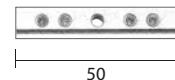
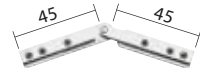
Alu Innenlauf-Profil Ø16mm, Stange 6m			Meter
	edelstahl	n90 616 e	35,90
Profilverbinder Messing			
	vernickelt	904 071	12,-
Profilverbinder Messing, beliebiger Winkel			
	vernickelt	904 072 - bw	28,80

Gehungsschnitt (ohne Profilverbinder)			Gehrung
	90°	1bg-1gs-90	20,-
	beliebiger Winkel	1bg-1gs-bw	49,-
Gleiter 100 Stück			Beutel
	Kunststoff weiß	3942 100	5,40
KLIXI-Drehgleiter 100 Stück			Beutel
	Kunststoff weiß	2400 100 w	12,-
Ösengleiter 100 Stück			Beutel
	Kunststoff weiß	3910 100	9,90
Gardinen-Einfachhaken 100 Stück			Beutel
	Kunststoff weiß	601 100	6,50
Gardinen-Doppelhaken 100 Stück			Beutel
	Kunststoff weiß	605 100	11,-

 Biegungen siehe Gruppe 10

Erker Ausführung



Biegung



Gehrung



Gelenk

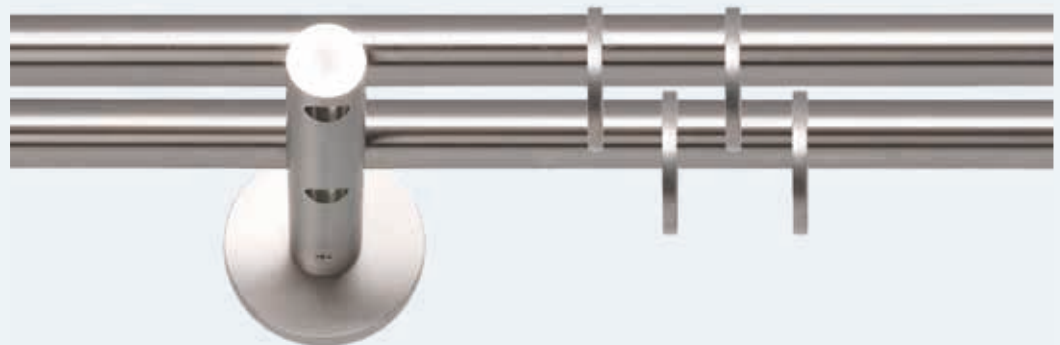
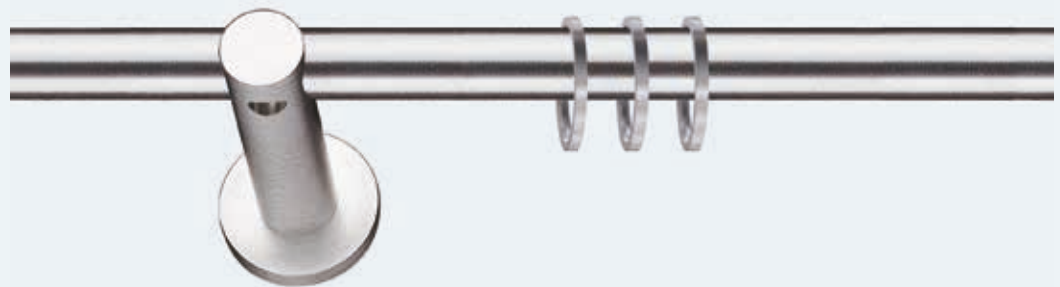

Farben Zubehör & Stangen



edelstahl

Offene Wandträger Rund

Garnituren mit Offenen Wandträgern Rund ohne Endknöpfe

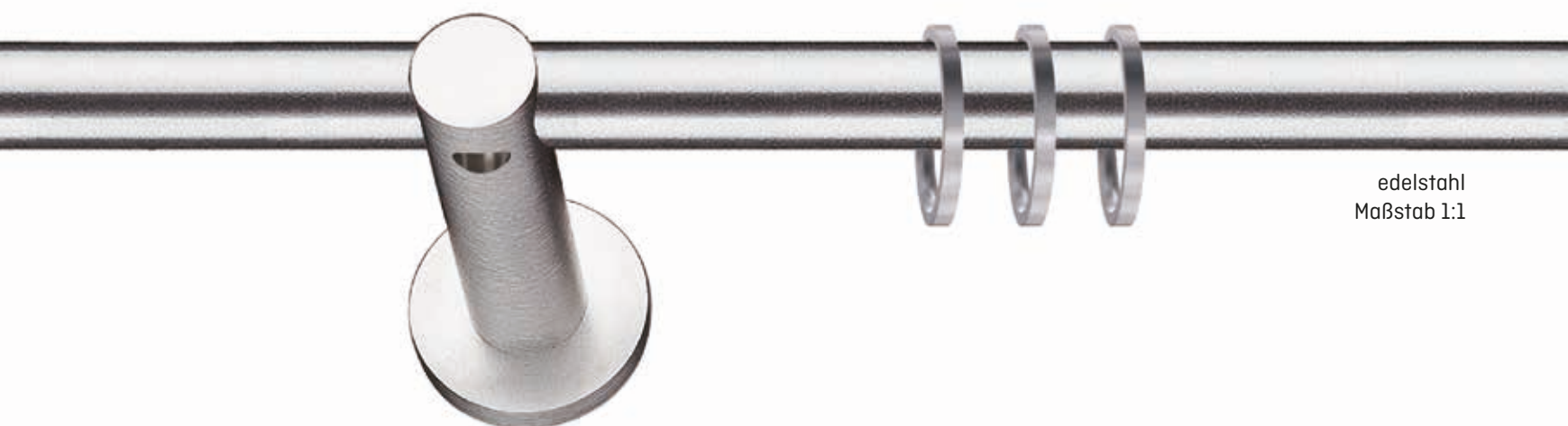

edelstahl
Maßstab 1:1

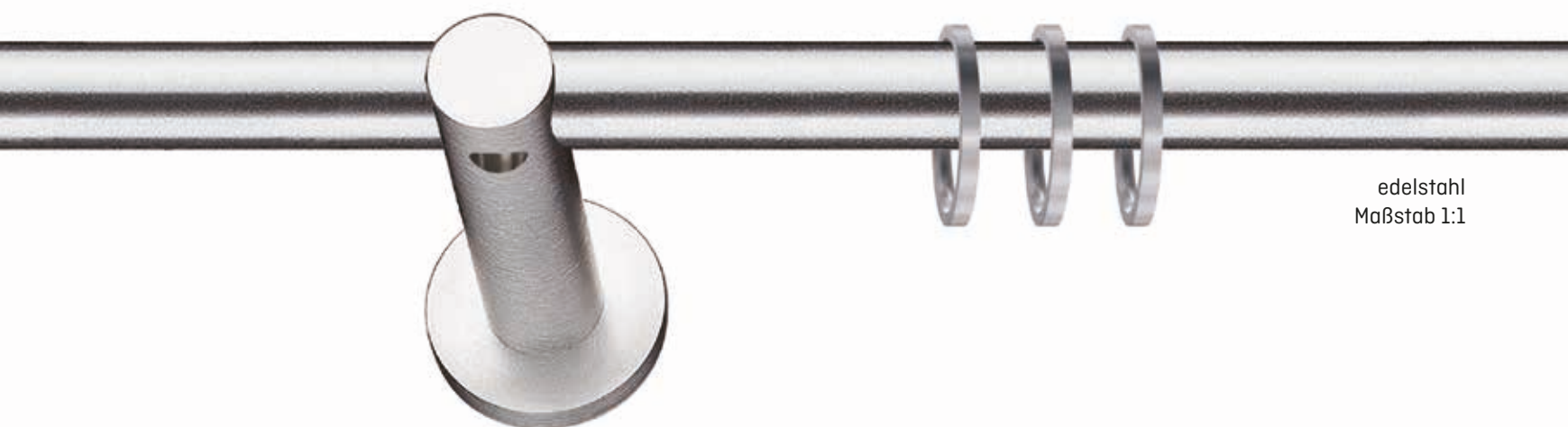

edelstahl
Maßstab 1:1

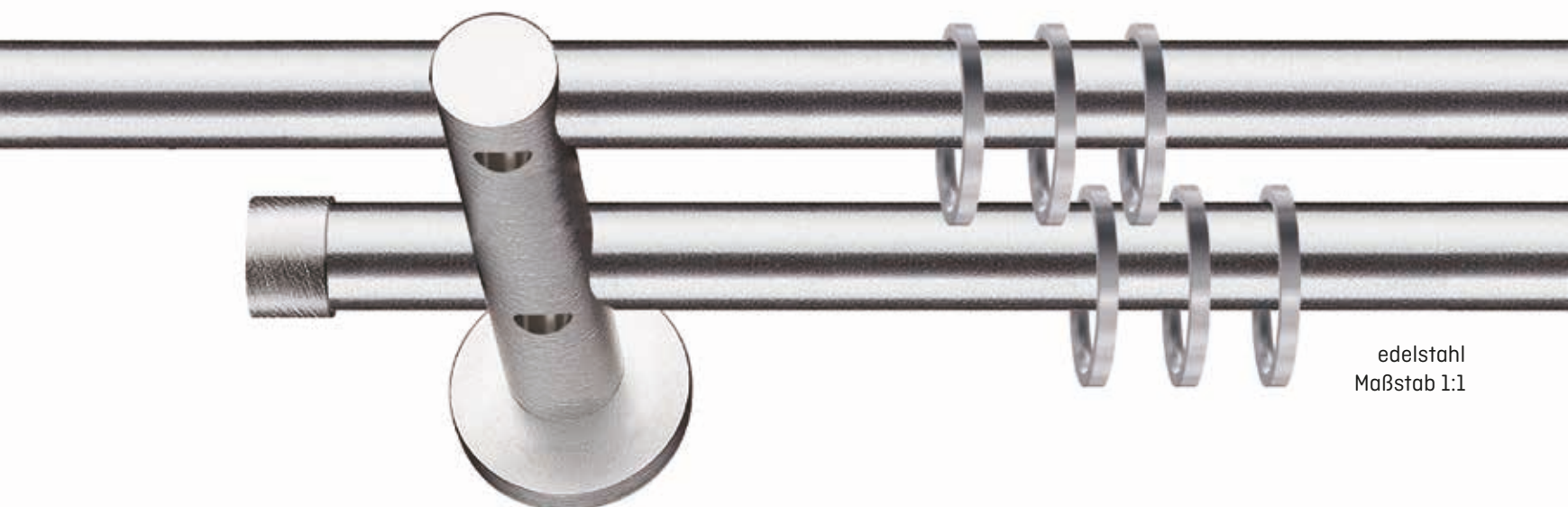

edelstahl
Maßstab 1:1

Lieferumfang

- ▶ **1 lfg:** 1 Edelstahl-Rohr Ø16mm oberflächenbehandelt, je nach Länge Wandträger und Ringe mit Faltenleghaken lt. Liste
 - ▶ **2 lfg:** 2 Edelstahl-Rohre Ø16mm oberflächenbehandelt, je nach Länge Wandträger und Ringe mit Faltenleghaken lt. Liste, 2 Endkappen
- ▶ mit Montagematerial
 - ▶ Bestellmaß = Rohrmaß
 - ▶ Trägermitte bis Ringunterkante: 15mm
 - ▶ bei geänderter Ausführung Aufpreis bzw. Preisänderung
 - ▶ **Aus produktionstechnischen Gründen bestehen geringfügige Farbabweichungen zwischen den Karniesenkomponenten.**

Trägermaße

Träger 1-läufig:

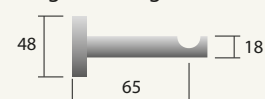

Träger 2-läufig:

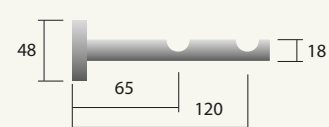

Maße in mm

Edelstahl
Ø16

Träger-
systeme

			 edelstahl	
Bestellcode:			t16-003	t16-004
Länge (cm)	Wand-träger	Ringe 1l./2l.	1lfg ○	2lfg ○○
100	2	14/28	123	226
120	2	16/32	133	247
140	2	20/40	143	268
160	2	22/44	153	289
180	3	24/48	197	352
200	3	28/56	207	373
220	3	30/60	217	394
240	3	34/68	227	415
260	3	36/72	237	436
280	3	38/76	247	457
300	3	42/84	257	478
320	3	44/88	267	499
340	3	48/96	277	520
360	4	50/100	329	593
380	4	52/104	339	614
400	4	56/112	349	635
+ 20cm	▲	3/6	10	21
Preisänderung bei Wandlager		1-seitig	+2,20	+13,90
		2-seitig	+4,30	+27,80

▲ ab einer Länge von ca. 500 cm bzw. bei schwereren Vorhängen wird ein weiterer Träger empfohlen (Aufpreis)

Träger kürzen: 19,-/Stück

Träger 1-läufig:

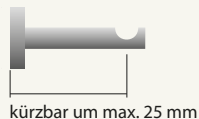

Träger 2-läufig:



Wandträger 1lfg - Wandabstand 65mm Stück

	edelstahl	815 116 e	34,80
---	-----------	-----------	-------

Wandträger 2lfg - Wandabstand 65/120mm Stück

	edelstahl	815 516 e	46,80
---	-----------	-----------	-------

Trägerverlängerung 35mm Stück

	edelstahl	871 043 e	15,60
---	-----------	-----------	-------

Endkappe Ø16mm Stück

	edelstahl	830 016 e	13,20
---	-----------	-----------	-------

Wandlager Ø16mm Stück

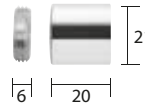
	edelstahl	82 316 e	33,60
---	-----------	----------	-------

Edelstahlrohr, Ø16mm, Stange 6m Meter

	edelstahl	es 1610	24,80
--	-----------	---------	-------

Rohrverbinder Ø16mm Stück

	Metall/Kunststoff	1716	13,20
---	-------------------	------	-------

Gelenkverbinder Ø16mm Stück

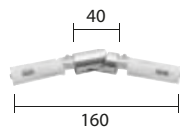
	edelstahl	8916 e	60,-
---	-----------	--------	------

Flachring Ø20mm + FH Stück

	edelstahl	847 201 e	2,-
---	-----------	-----------	-----

Flachring Ø20mm mit Kunststoffeinlage + FH Stück

	nickel matt	848 201 n	3,60
---	-------------	-----------	------

Faltenleghaken Stück

	Kunststoff glasklar	36003 gk	0,10
---	---------------------	----------	------

flüX

Ø20

Edelstahl
Ø20



Edelstahl Ø20mm

Edelstahl Ø20mm - Trägersysteme



Seite 45



Seite 49

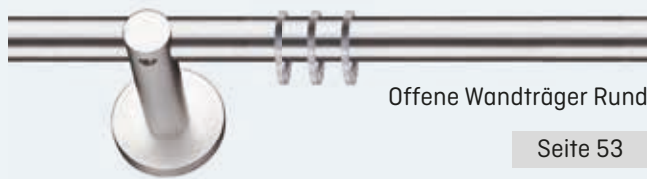

Seite 53

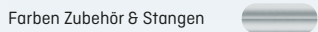

Seite 53

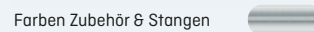

Seite 53

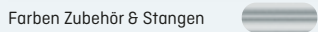

Edelstahl Ø20mm - Endknöpfe





Anna
FLÄCHENBÜNDIG

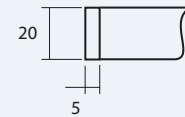

Finn
FLÄCHENBÜNDIG

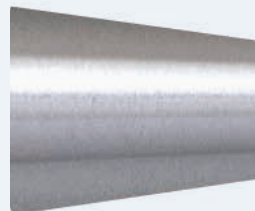
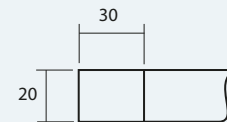

Theo
FLÄCHENBÜNDIG

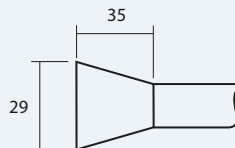

Endknöpfe Edelstahl Ø20 mm

Anna

FLÄCHENBÜNDIG



edelstahl
Maßstab 1:1

Endknopf Anna		Stück
edelstahl	831 420 e	22,80

Finn

FLÄCHENBÜNDIG



edelstahl
Maßstab 1:1

Endknopf Finn		Stück
edelstahl	831 720 e	30,-

Theo

FLÄCHENBÜNDIG



edelstahl
Maßstab 1:1

Endknopf Theo		Stück
edelstahl	831 820 e	30,-

Leichte Farbunterschiede zwischen Stange, Endknöpfen und Wandträger können aus produktionstechnischen Gründen auftreten.



Hestia
FLÄCHENBÜNDIG

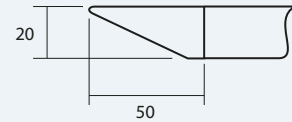

Apollon
FLÄCHENBÜNDIG

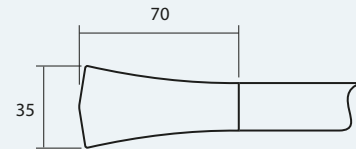

Termoli
FLÄCHENBÜNDIG

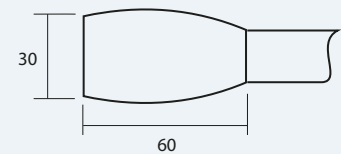

Endknöpfe Edelstahl Ø20 mm

Hestia

FLÄCHENBÜNDIG



edelstahl
Maßstab 1:1

Endknopf Hestia		Stück
edelstahl	832 820 e	30,-

Apollon

FLÄCHENBÜNDIG



edelstahl
Maßstab 1:1

Endknopf Apollon		Stück
edelstahl	834 420 e	58,80

Termoli

FLÄCHENBÜNDIG



edelstahl
Maßstab 1:1

Endknopf Termoli		Stück
edelstahl	836 120 e	58,80

Leichte Farbunterschiede zwischen Stange, Endknöpfen und Wandträger können aus produktionstechnischen Gründen auftreten.



Olymp
FLÄCHENBÜNDIG

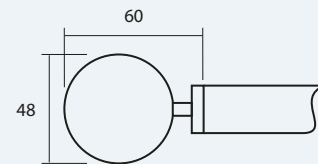

Pan

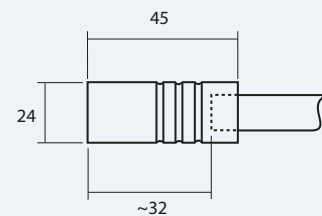

Sabine

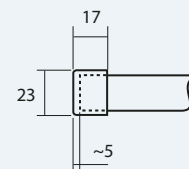

Endknöpfe Edelstahl Ø20 mm

Olymp

FLÄCHENBÜNDIG

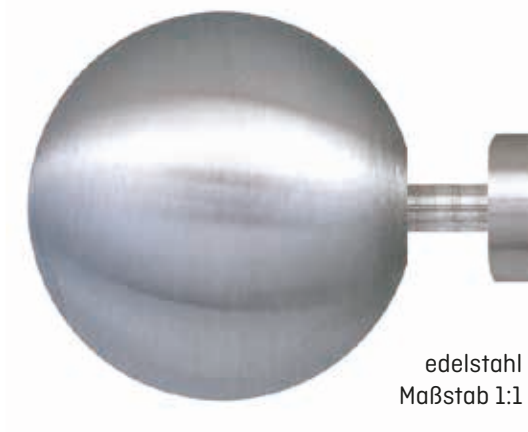

edelstahl
Maßstab 1:1

Endknopf Olymp		Stück
edelstahl	 834 720 e	76,80

Pan

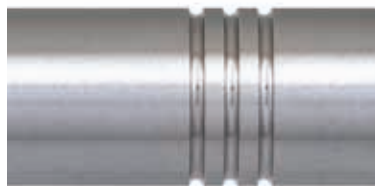

edelstahl
Maßstab 1:1

Endknopf Pan		Stück
edelstahl	 837 821 e	28,80

Sabine



edelstahl
Maßstab 1:1

Endknopf Sabine		Stück
edelstahl	 830 020 e	14,40

Leichte Farbunterschiede zwischen Stange, Endknöpfen und Wandträger können aus produktionstechnischen Gründen auftreten.

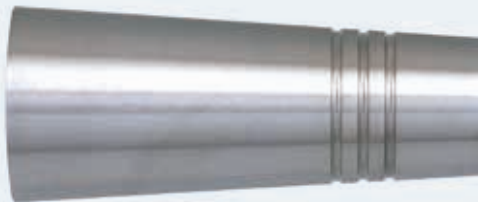

Padua

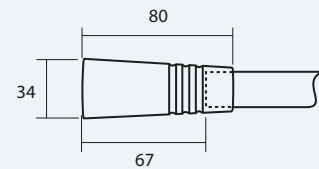

Catania

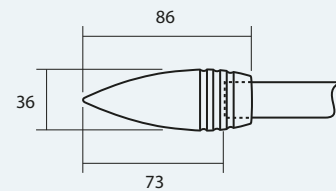

Fenja

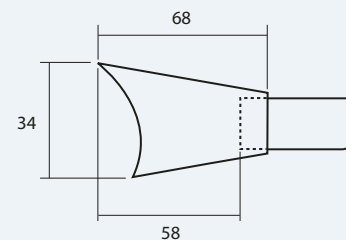

Endknöpfe Edelstahl Ø20 mm

Padua



edelstahl
Maßstab 1:1

Endknopf Padua		Stück
edelstahl	 850 220 e	37,20

Catania



edelstahl
Maßstab 1:1

Endknopf Catania		Stück
edelstahl	 850 120 e	37,20

Fenja



edelstahl
Maßstab 1:1

Endknopf Fenja		Stück
edelstahl	 839 220 e	73,-

Leichte Farbunterschiede zwischen Stange, Endknöpfen und Wandträger können aus produktionstechnischen Gründen auftreten.

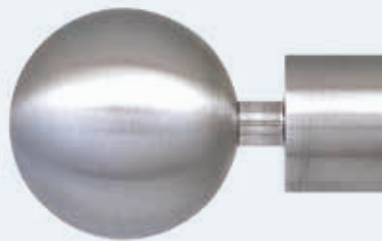

Modica

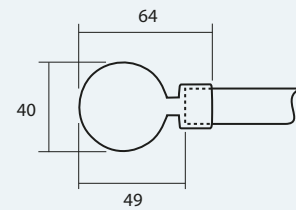

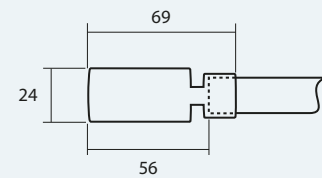

Siena

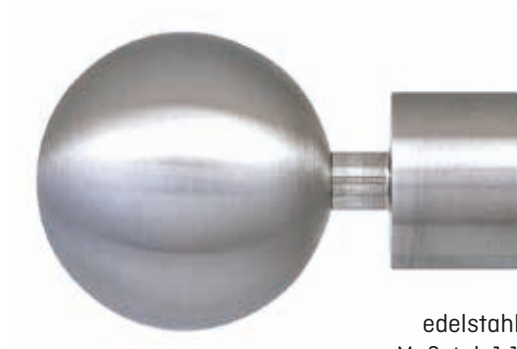

Endknöpfe Edelstahl Ø20 mm

Modica



Endknopf Modica		Stück
edelstahl	 835 920 e	40,80

Siena

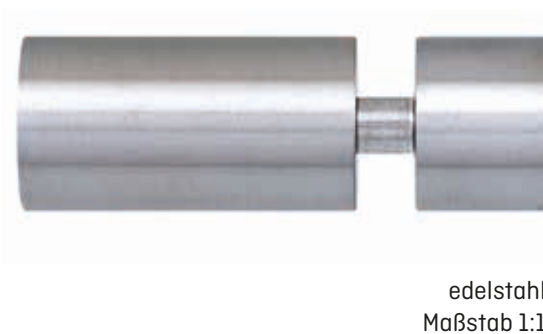

Endknopf Siena		Stück
edelstahl	 835 820 e	40,80

Leichte Farbunterschiede zwischen Stange, Endknöpfen und Wandträger können aus produktionstechnischen Gründen auftreten.



Ø20

Edelstahl
Ø20

Träger-
systeme

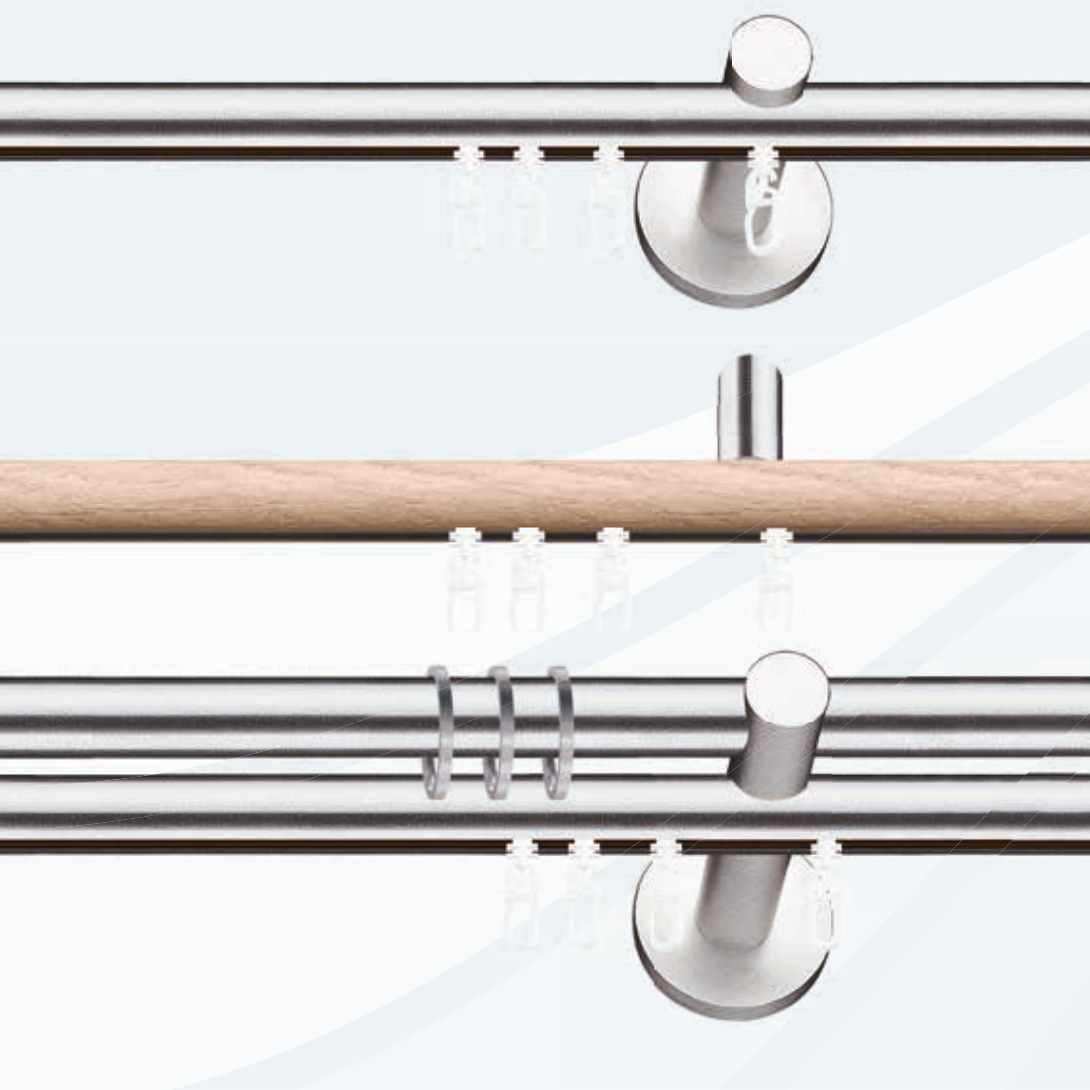

Edelstahl Ø20mm Trägersysteme

Edelstahl Ø20mm - Trägersysteme

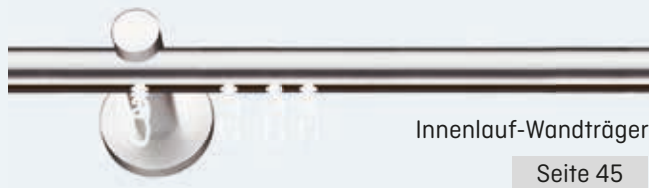

Farben Zubehör



Farben Stangen



Farben Zubehör



Farben Stangen



Farben Zubehör & Stangen



Farben Zubehör & Stangen



Farben Zubehör & Stangen





EDELSTAHL

Ø20



mit KLIXI
Drehgleiter

Erkerausführung



Biegung



Gehrung



Gelenk

Edelstahl
Ø20

Träger-
systeme



Farben Zubehör



edelstahl

Farben Innenlauf-Profile



edelstahl



schwarz matt



buche*



wildeiche*



zwetschke*

* IL-Profile in buche, wildeiche, zwetschke: Laufroller Art. 2420

Innenlauf-Wandträger

Garnituren mit Innenlauf-Wandträgern ohne Endknöpfe

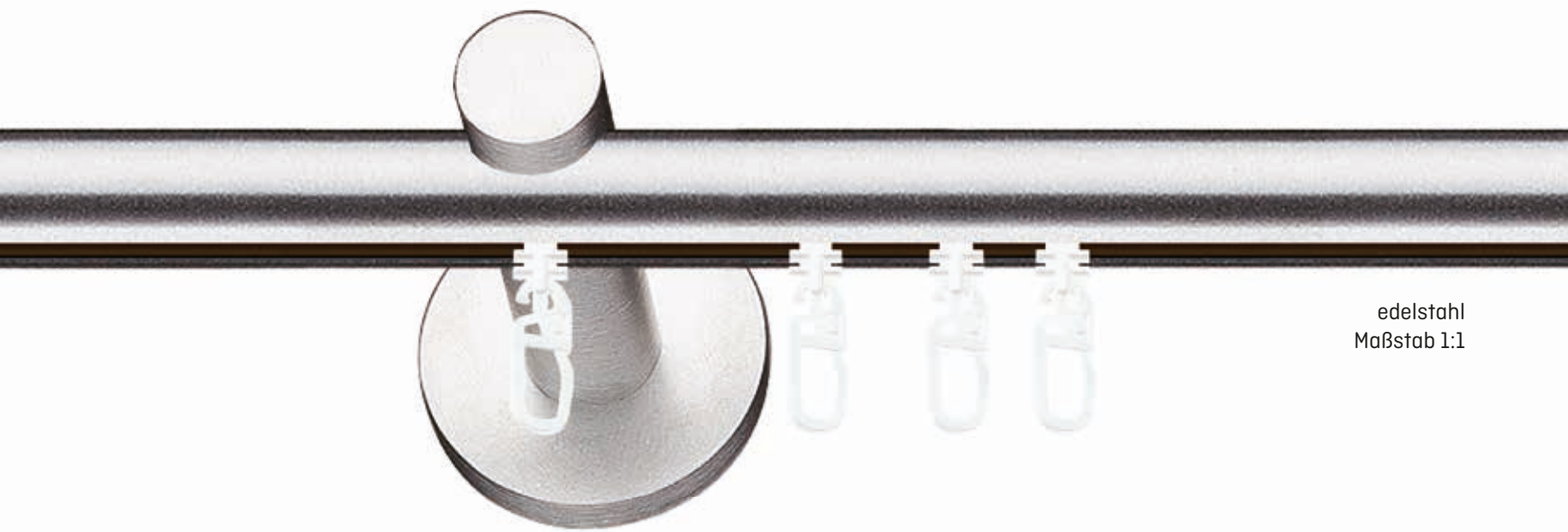

edelstahl
Maßstab 1:1



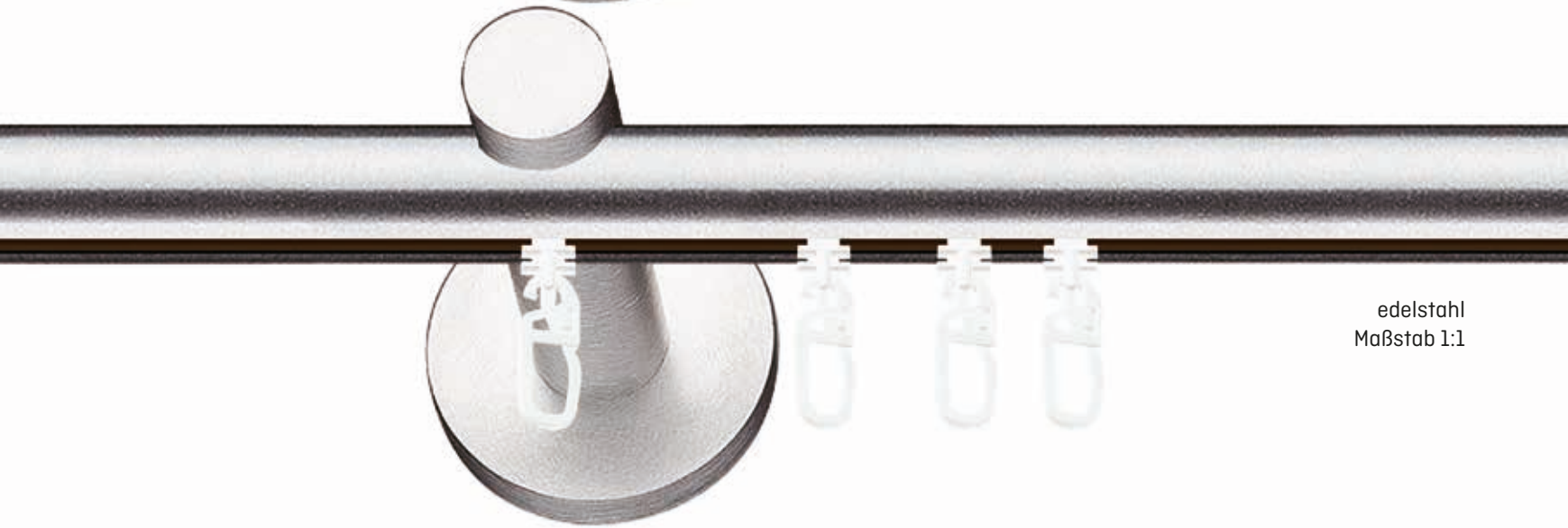

edelstahl/wildeiche
Maßstab 1:1



edelstahl
Maßstab 1:1

Lieferumfang

- ▶ **1 lfg:** 1 Alu Innenlauf-Profil Ø20mm oberflächenbehandelt, je nach Länge Wandträger und -Drehgleiter lt. Liste
- ▶ **2 lfg:** 2 Alu Innenlauf-Profile Ø20mm oberflächenbehandelt, je nach Länge Wandträger und -Drehgleiter lt. Liste, 2 Endkappen

- ▶ mit Montagematerial
- ▶ Bestellmaß = Profilmaß
- ▶ Trägermitte bis Innenlaufprofil-Unterkante: 20mm
- ▶ bei geänderter Ausführung Aufpreis bzw. Preisänderung
- ▶ **Aus produktionstechnischen Gründen bestehen geringfügige Farbabweichungen zwischen den Karniesenkomponenten.**
- ▶ **IL-Profile in buche, wildeiche, zwetschke: nur Laufroller Art. 2420 ohne Aufpreis**

Trägermaße

Träger 1-läufig:

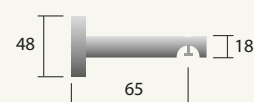

Träger 2-läufig:

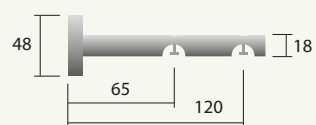

Maße in mm

Edelstahl
Ø20

Träger-
systeme

			edelstahl		Preisänderung für IL-Profil in:	
Bestellcode:			t20-007	t20-008		
Länge (cm)	Wand-träger	Gleiter 1l./2l.	1lfg (H)	2lfg (H)(H)	1lfg (H)	2lfg (H)(H)
100	2	16/32	106	195	0	0
120	2	18/36	113	210	0	0
140	2	22/44	120	225	0	0
160	2	26/52	127	240	0	0
180	2	28/54	134	255	0	0
200	2	32/64	141	270	0	0
220	3	34/68	184	329	0	0
240	3	38/76	191	344	0	0
260	3	42/84	198	359	0	0
280	3	44/88	205	374	0	0
300	3	48/96	212	389	0	0
320	3	50/100	219	404	0	0
340	3	54/108	226	419	0	0
360	3	58/116	233	434	0	0
380	3	60/120	240	449	0	0
400	4	64/128	285	508	0	0
+ 20 cm ▲		3/6	7	15	-	-
Preisänderung Wandlager	1-seitig		-1,20	+6		
	2-seitig		-2,40	+12		

-  buche
-  wildeiche
-  zwetschke
-  schwarz matt

▲ ab einer Länge von ca. 580 cm bzw. bei schwereren Vorhängen wird ein weiterer Träger empfohlen (Aufpreis)

Träger kürzen: 19,-/Stück

Träger 1-läufig:

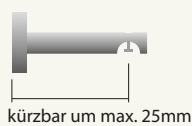

Träger 2-läufig:

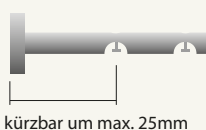

Wandträger 1lfg - Wandabstand 65mm Stück

	edelstahl	871 052 e	34,80
---	-----------	-----------	-------

Wandträger 2lfg - Wandabstand 65/120mm Stück

	edelstahl	871 142 e	46,80
---	-----------	-----------	-------

Trägerverlängerung 35mm Stück

	edelstahl	871 043 e	15,60
---	-----------	-----------	-------

Endkappe Ø20mm Stück

	edelstahl	830 020 e	14,40
---	-----------	-----------	-------

Endkappe flächenbündig Ø20mm Stück

	edelstahl	831 420 e	22,80
---	-----------	-----------	-------

Wandlager Ø20mm Stück

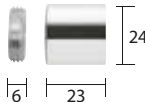
	edelstahl	82 320 e	33,60
--	-----------	----------	-------

Alu Innenlauf-Profil Ø20mm, Stange 6m Meter

	edelstahl	n90 620 e	41,40
	buche	n90 620 bu	41,40
	wildeiche	n90 620 wi	41,40
	zwetschke	n90 620 zw	41,40
	schwarz matt	n90 620 sm	38,60

Profilverbinder Messing Stück

	vernickelt	904 071	12,-
--	------------	---------	------

Profilverbinder Messing, beliebiger Winkel Stück

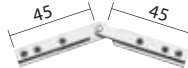
	vernickelt	904 072 - bw	28,80
--	------------	--------------	-------

Gehungsschnitt (ohne Profilverbinder) Gehrung

	90°	1bg-1gs-90	20,-
	beliebiger Winkel	1bg-1gs-bw	49,-

KLIXI-Drehgleiter 100 Stück Beutel

	Kunststoff grau	2400 100 g	12,-
	Kunststoff weiß	2400 100 w	12,-

Gleiter 100 Stück Beutel

	Kunststoff weiß	3942 100	5,40
---	-----------------	----------	------

Ösengleiter 100 Stück Beutel

	Kunststoff weiß	3910 100	9,90
---	-----------------	----------	------

Gardinen-Einfachhaken 100 Stück Beutel

	Kunststoff weiß	601 100	6,50
---	-----------------	---------	------

Gardinen-Doppelhaken 100 Stück Beutel

	Kunststoff weiß	605 100	11,-
---	-----------------	---------	------

Roller mit Faltenleghaken Stück

	Kunststoff weiß	2420	0,20
---	-----------------	------	------

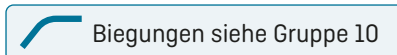



EDELSTAHL

Ø20



mit KLIXI
Drehgleiter

Erkerausführung



Biegung



Gehrung



Gelenk

Edelstahl
Ø20

Träger-
systeme



Farben Zubehör



edelstahl

Farben Innenlauf-Profile



edelstahl

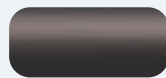

schwarz matt



buche*



wildeiche*



zwetschke*

* IL-Profile in buche, wildeiche, zwetschke: Laufroller Art. 2420

Innenlauf-Deckenträger

Garnituren mit Innenlauf-Deckenträgern ohne Endknöpfe

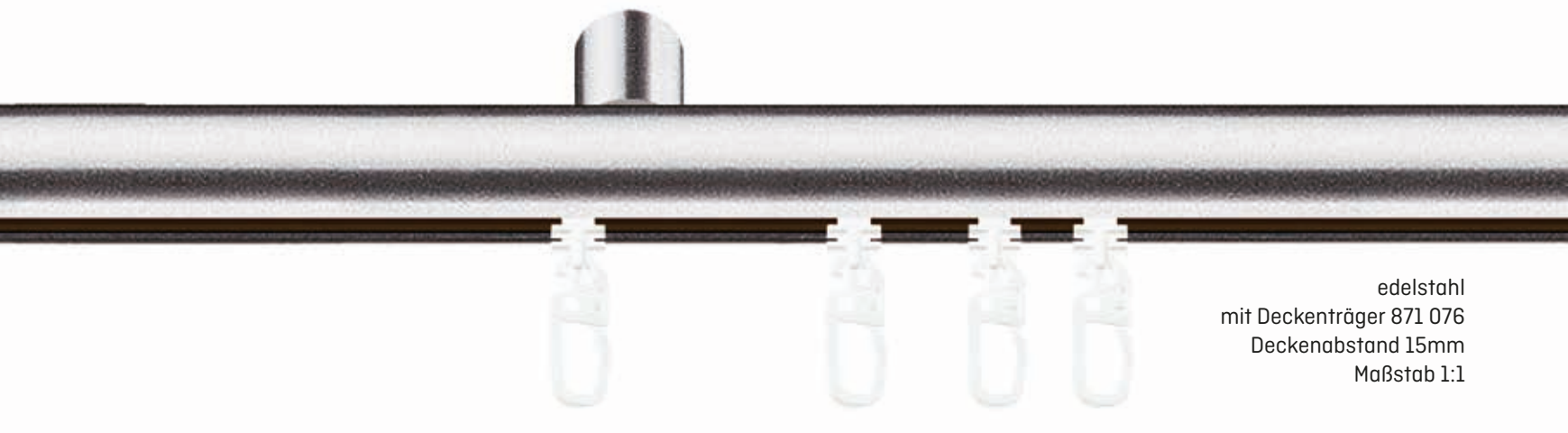

edelstahl
mit Deckenträger 871 076
Deckenabstand 15mm
Maßstab 1:1





edelstahl/wildeiche
mit Deckenträger 871 077
Deckenabstand 35mm
Maßstab 1:1



edelstahl
mit Deckenträger 871 053
Deckenabstand 43mm
Maßstab 1:1

Lieferumfang

- ▶ **1 lfg mit Deckenträger 15mm Deckenabstand:**
1 Alu Innenlauf-Profil Ø20mm oberflächenbehandelt, je nach Länge Deckenträger und -Drehgleiter lt. Liste
- ▶ **1 lfg mit Deckenträger 35mm Deckenabstand:**
1 Alu Innenlauf-Profil Ø20mm oberflächenbehandelt, je nach Länge Deckenträger und -Drehgleiter lt. Liste
- ▶ **1 lfg mit Deckenträger 43mm Deckenabstand:**
1 Alu Innenlauf-Profil Ø20mm oberflächenbehandelt, je nach Länge Deckenträger und -Drehgleiter lt. Liste

- ▶ mit Montagematerial
- ▶ Bestellmaß = Profilmaß
- ▶ Decke bis Innenlauf-Profilunterkante: siehe Maßskizzen rechts
- ▶ bei geänderter Ausführung Aufpreis bzw. Preisabschlag
- ▶ **Aus produktionstechnischen Gründen bestehen geringfügige Farbabweichungen zwischen den Karniesenkomponenten.**
- ▶ **IL-Profile in buche, wildeiche, zwetschke: nur Laufroller Art. 2420 ohne Aufpreis**

Trägermaße

Träger 1-läufig Art. 871 076
Deckenabstand 15mm:

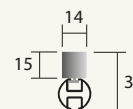

Träger 1-läufig Art. 871 077
Deckenabstand 35mm:

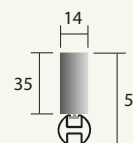



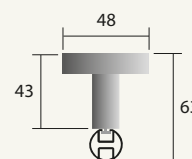

Träger 1-läufig Art. 871 053
Deckenabstand 43mm:





Maße in mm

Edelstahl
Ø20

Träger-
systeme

			edelstahl			Preisänderung für IL-Profil in:
Bestellcode:			t20-301	t20-302	t20-303	
Länge (cm)	Decken-träger	Gleiter	1lfg 	1lfg 	1lfg 	1lfg 
100	2	16	80	84	113	0
120	2	18	87	91	120	0
140	2	22	94	98	127	0
160	2	26	101	105	134	0
180	2	28	108	112	141	0
200	2	32	115	119	148	0
220	3	34	145	152	195	0
240	3	38	152	159	202	0
260	3	42	159	166	209	0
280	3	44	166	173	216	0
300	3	48	173	180	223	0
320	3	50	180	187	230	0
340	3	54	187	194	237	0
360	3	58	194	201	244	0
380	3	60	201	208	251	0
400	4	64	232	242	299	0
+ 20 cm	▲	3	7	7	7	-

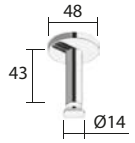
▲ ab einer Länge von ca. 580 cm bzw. bei schwereren Vorhängen wird ein weiterer Träger empfohlen (Aufpreis)

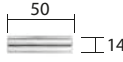
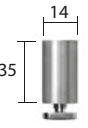
Träger und passende Verlängerungen			
Deckenträger 1lfg., Deckenabstand 43mm/Ø14mm Stück			
	edelstahl	871 053 e	34,80
Deckenträger, Deckenabstand 15mm Stück			
	edelstahl	871 076 e	21,60
Trägerverlängerung 50mm Stück			
	edelstahl	810 735 e	16,80
Deckenträger, Deckenabstand 35mm Stück			
	edelstahl	871 077 e	24,-

Deckenträger kürzbar - Deckenabstand 42-500mm Stück			
	edelstahl	871 084 e	57,60

Endkappe Ø20mm Stück			
	edelstahl	830 020 e	14,40

Endkappe flächenbündig Ø20mm Stück			
	edelstahl	831 420 e	22,80

Wandlager Ø20mm Stück			
	edelstahl	82 320 e	33,60

Alu Innenlauf-Profilrohr Ø20mm, Stange 6m Meter			
	edelstahl	n90 620 e	41,40
	buche	n90 620 bu	41,40
	wildeiche	n90 620 wi	41,40
	zwetschke	n90 620 zw	41,40
	schwarz matt	n90 620 sm	38,60

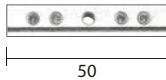
Profilverbinder Messing			Stück
	vernickelt	904 071	12,-

Profilverbinder Messing, beliebiger Winkel			Stück
	vernickelt	904 072 - bw	28,80

Gehrungsschnitt (ohne Profilverbinder)			Gehrung
	90°	1bg-1gs-90	20,-
	beliebiger Winkel	1bg-1gs-bw	49,-

KLIXI-Drehgleiter 100 Stück			Beutel
	Kunststoff grau	2400 100 g	12,-
	Kunststoff weiß	2400 100 w	12,-

Gleiter 100 Stück			Beutel
	Kunststoff	3942 100	5,40

Ösengleiter 100 Stück			Beutel
	Kunststoff weiß	3910 100	9,90

Gardinen-Einfachhaken 100 Stück			Beutel
	Kunststoff weiß	601 100	6,50

Gardinen-Doppelhaken 100 Stück			Beutel
	Kunststoff weiß	605 100	11,-

Roller mit Faltenleghaken			Stück
	Kunststoff weiß	2420	0,20

 Biegungen siehe Gruppe 10

Erkerausführung



Biegung



Gehrung



Gelenk

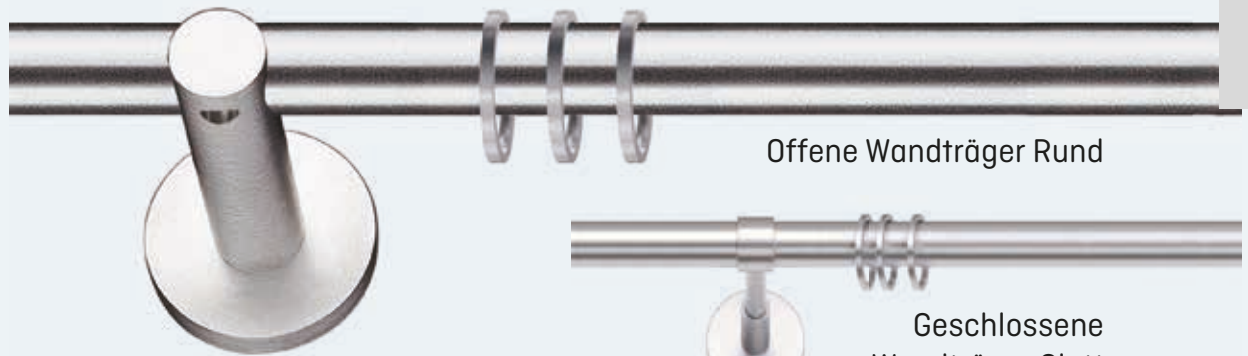

Offene Wandträger Rund

Geschlossene
Wandträger Glatt



mit KLIXI
Drehgleiter

Erkerausführung



Biegung



Gehrung



Gelenk

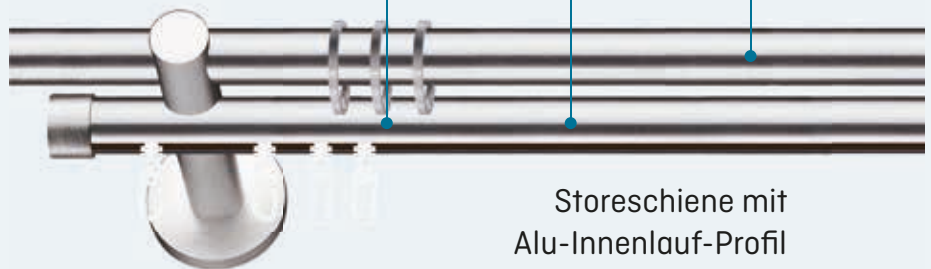

Storeschiene mit
Alu-Innenlauf-Profil

Farben Zubehör & Stangen



edelstahl

Geschlossene Wandträger Glatt

Offene Wandträger Rund

Storeschiene mit Alu-Innenlauf-Profil

Garnituren ohne Endknöpfe

Garnituren mit Geschlossenen Wandträgern Glatt

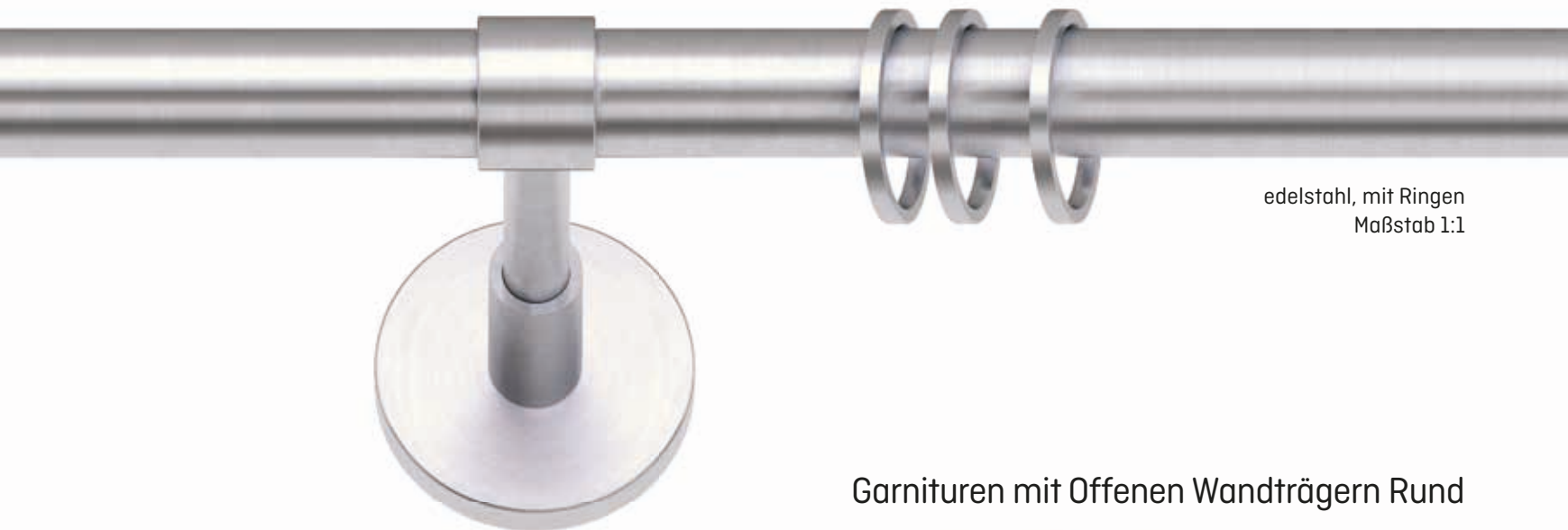

edelstahl, mit Ringen
Maßstab 1:1

Garnituren mit Offenen Wandträgern Rund



edelstahl, mit Ringen
Maßstab 1:1

Garnituren mit Storeschiene Alu-Innenlauf-Profil

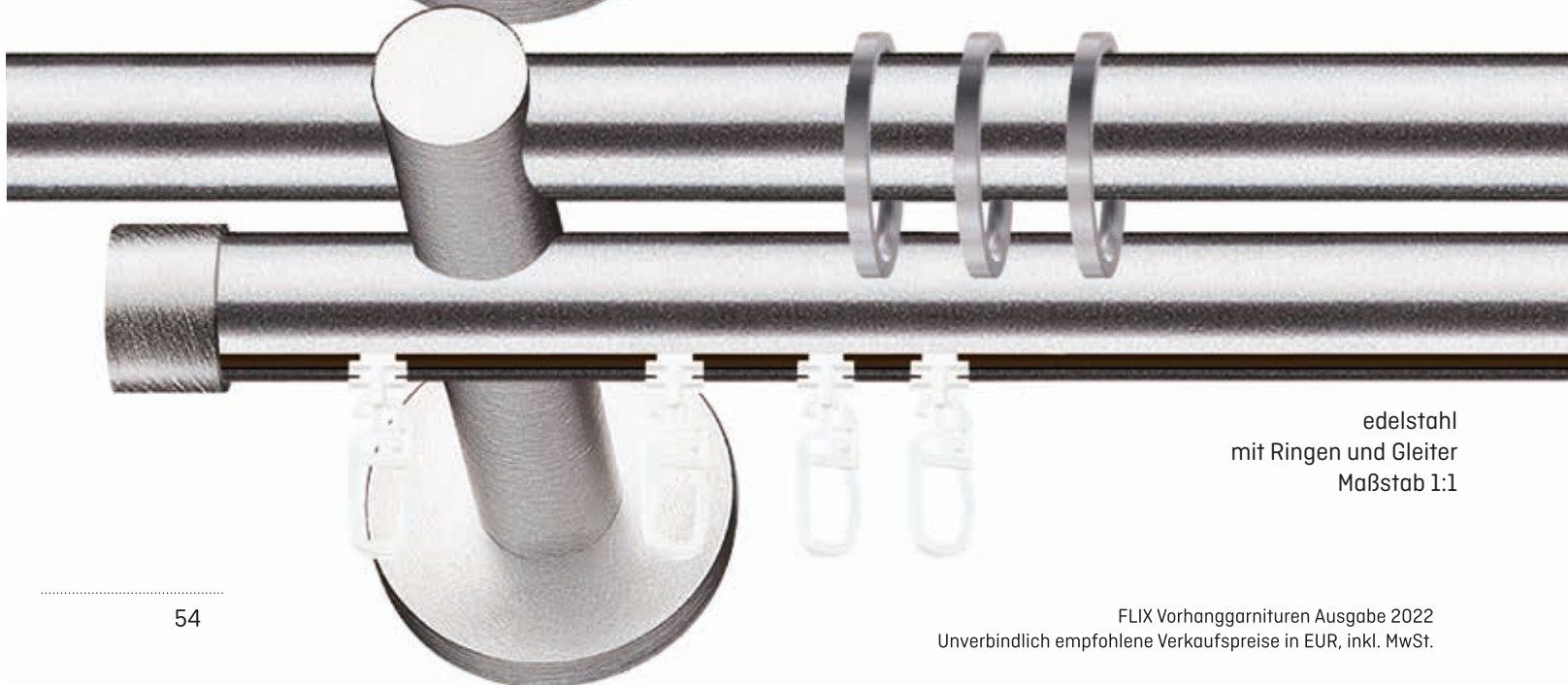

edelstahl
mit Ringen und Gleiter
Maßstab 1:1

Lieferumfang

- ▶ **1 lfg:** 1 Edelstahl-Rohr Ø20mm oberflächenbehandelt, je nach Länge Wandträger und Ringe mit Faltenleghaken lt. Liste
- ▶ **2 lfg:** 2 Edelstahl-Rohre Ø20mm oberflächenbehandelt, je nach Länge Wandträger und Ringe mit Faltenleghaken lt. Liste, 2 Endkappen
- ▶ **2 lfg mit Alu Innenlauf-Profil als 2. Lauf:** 1 Edelstahl-Rohr Ø20mm oberflächenbehandelt, 1 Alu Innenlauf-Profil Ø20mm oberflächenbehandelt, je nach Länge Wandträger, Ringe mit Faltenleghaken und  -Drehgleiter lt. Liste, 2 Endkappen



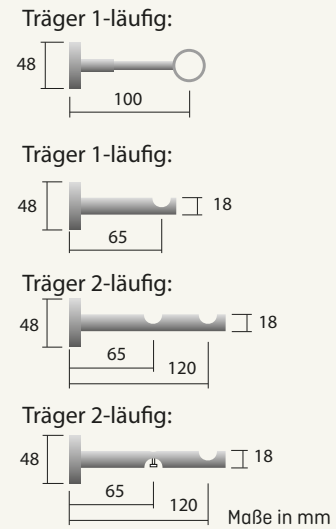

- ▶ mit Montagematerial
- ▶ Bestellmaß = Rohr-/Profilmaß
- ▶ Trägermitte bis Ringunterkante: 22mm
- ▶ Trägermitte bis Stangenunterkante (IL): 20mm
- ▶ bei geänderter Ausführung Aufpreis bzw. Preisänderung
- ▶ **Aus produktionstechnischen Gründen bestehen geringfügige Farbabweichungen zwischen den Karniesenkomponenten.**

Trägermaße



Edelstahl
Ø20



Träger-
systeme

			 edelstahl				
Bestellcode:			t20-005	t20-003	t20-004	t20-009 Storeschiene mit Alu-IL-Profil	
Länge (cm)	Wand-träger	Ringe 1l./2l.	1lfg 	1lfg 	2lfg 	Ringe/Gleiter	2lfg 
100	2	14/28	161	125	233	14/16	214
120	2	16/32	172	136	255	16/18	232
140	2	20/40	183	147	277	20/22	250
160	2	22/44	194	158	299	22/26	268
180	2	24/48	205	169	321	24/28	286
200	2	28/56	216	180	343	28/32	304
220	3	30/60	278	224	409	30/34	369
240	3	34/68	289	235	431	34/38	387
260	3	36/72	300	246	453	36/42	405
280	3	38/76	311	257	475	38/44	423
300	3	42/84	322	268	497	42/48	441
320	3	44/88	333	279	519	44/50	459
340	3	48/96	344	290	541	48/54	477
360	3	50/100	355	301	563	50/58	495
380	3	52/104	366	312	585	52/60	513
400	4	56/112	433	361	659	56/64	583
+ 20cm	▲	3/6	11	11	22	3 / 6	18
Preisänderung bei Wandlager	1-seitig		-19	-1,20	+6		+6
	2-seitig		-38	-2,40	+12		+12

▲ ab einer Länge von ca. 580 cm bzw. bei schwereren Vorhängen wird ein weiterer Träger empfohlen (Aufpreis)

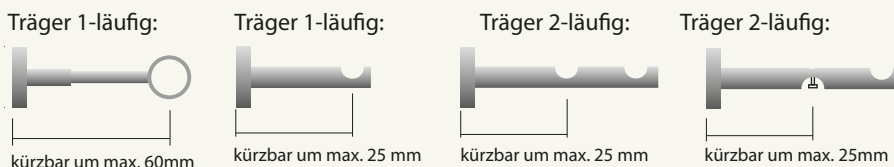
Träger kürzen: 19,-/Stück



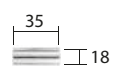

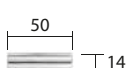
Träger und passende Verlängerungen			
Wandträger 1lfg - Wandabstand 65mm	Stück		
 I18 edelstahl	871 063 e	34,80	
Wandträger 2lfg - Wandabstand 65/120mm	Stück		
 I18 edelstahl	871 064 e	46,80	
Wandträger 2. Rohr als IL-Rohr - WA 65/120mm	Stück		
 I18 edelstahl	871 054 e	46,80	
Trägerverlängerung 35mm	Stück		
 35 I18 edelstahl	871 043 e	15,60	

Träger und passende Verlängerungen			
Wandträger 1lfg - Wandabstand 100mm	Stück		
 edelstahl	810 730 e	48,-	
Trägerverlängerung 50mm	Stück		
 50 I14 edelstahl	810 735 e	16,80	

Endkappe Ø20mm			
 edelstahl	830 020 e	14,40	

Endkappe flächenbündig Ø20mm			
 20 I51 edelstahl	831 420 e	22,80	

Wandlager Ø20mm			
 24 I6 I23 edelstahl	82 320 e	33,60	

Edelstahlrohr, Ø20mm, Stange 6m			
 edelstahl	es 2010	27,60	

Rohrverbinder Ø20mm			
 Metall/Kunststoff	1720	14,40	

Gelenkverbinder Ø20mm			
 40 I160 edelstahl	8920 e	66,-	

Flachring Ø20mm mit Kunststoffeinlage + FH			
 34 I27 nickel matt	848 201 n	3,60	

Flachring Ø20mm + FH			
 32 I28 edelstahl	847 201 e	2,-	

Faltenleghaken			
 Kunststoff glasklar	36003 gk	0,10	

Alu Innenlauf-Profil Ø20mm, Stange 6m			
 edelstahl	n90 620 e	41,40	

Profilverbinder Messing			
 50 vernickelt	904 071	12,-	

Profilverbinder Messing, beliebiger Winkel			
 45 45 vernickelt	904 072 - bw	28,80	

Gehrungsschnitt (ohne Profilverbinder)			
 90°	1bg-1gs-90	20,-	
	beliebiger Winkel	1bg-1gs-bw	49,-

KLIXI-Drehgleiter 100 Stück			
 KLIXI Kunststoff grau	2400 100 g	12,-	
	Kunststoff weiß	2400 100 w	12,-

Gleiter 100 Stück			
 Kunststoff weiß	3942 100	5,40	

Ösengleiter 100 Stück			
 Kunststoff weiß	3910 100	9,90	

Gardinen-Einfachhaken 100 Stück			
 Kunststoff weiß	601 100	6,50	

Gardinen-Doppelhaken 100 Stück			
 Kunststoff weiß	605 100	11,-	

Roller mit Faltenleghaken			
 I28 Kunststoff weiß	2420	0,20	

 Biegungen siehe Gruppe 10

OOOO
FLIX

Ø28



Edelstahl
Ø28

Edelstahl Ø28mm

Edelstahl Ø28mm - Trägersysteme



Innenlauf-Wandträger

Seite 65

Farben Zubehör



Farben Stangen



Innenlauf-Deckenträger

Seite 65

Farben Zubehör



Farben Stangen



Geschlossene Wandträger Glatt

Seite 69

Farben Zubehör & Stangen



Offene Wandträger Rund

Seite 69

Farben Zubehör & Stangen



Edelstahl Ø28mm - Endknöpfe

Anna flächenbündig



Seite 59

Pan flächenbündig



Seite 59

Themis flächenbündig



Seite 59

Marsala



Seite 61

Firenze flächenbündig



Seite 61



Anna
FLÄCHENBÜNDIG

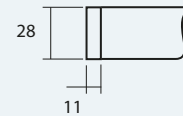

Pan
FLÄCHENBÜNDIG

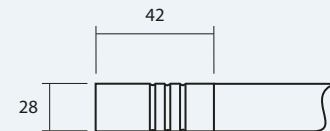

Themis
FLÄCHENBÜNDIG

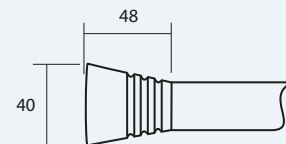

Endknöpfe Edelstahl Ø28 mm

Anna

FLÄCHENBÜNDIG



edelstahl
Maßstab 1:1

Endknopf Anna		Stück
edelstahl	831 428 e	26,40

Pan

FLÄCHENBÜNDIG



edelstahl
Maßstab 1:1

Endknopf Pan		Stück
edelstahl	850 929 e	51,60

Themis

FLÄCHENBÜNDIG

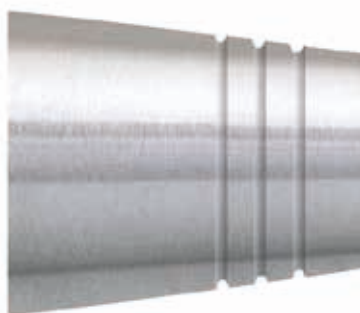

edelstahl
Maßstab 1:1

Endknopf Themis		Stück
edelstahl	850 930 e	51,60

Leichte Farbunterschiede zwischen Stange, Endknöpfen und Wandträger können aus produktionstechnischen Gründen auftreten.

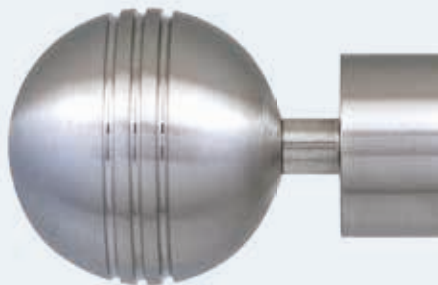

Marsala

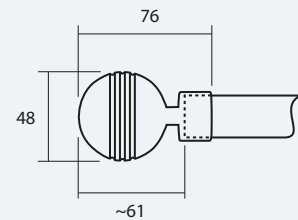

Firenze
FLÄCHENBÜNDIG

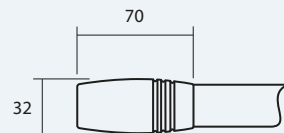

Endknöpfe Edelstahl Ø28 mm

Marsala



edelstahl
Maßstab 1:1

Endknopf Marsala		Stück
edelstahl	 850 828 e	62,40

Firenze

FLÄCHENBÜNDIG



edelstahl
Maßstab 1:1

Endknopf Firenze		Stück
edelstahl	 850 931 e	51,60

Leichte Farbunterschiede zwischen Stange, Endknöpfen und Wandträger können aus produktionstechnischen Gründen auftreten.



Ø28

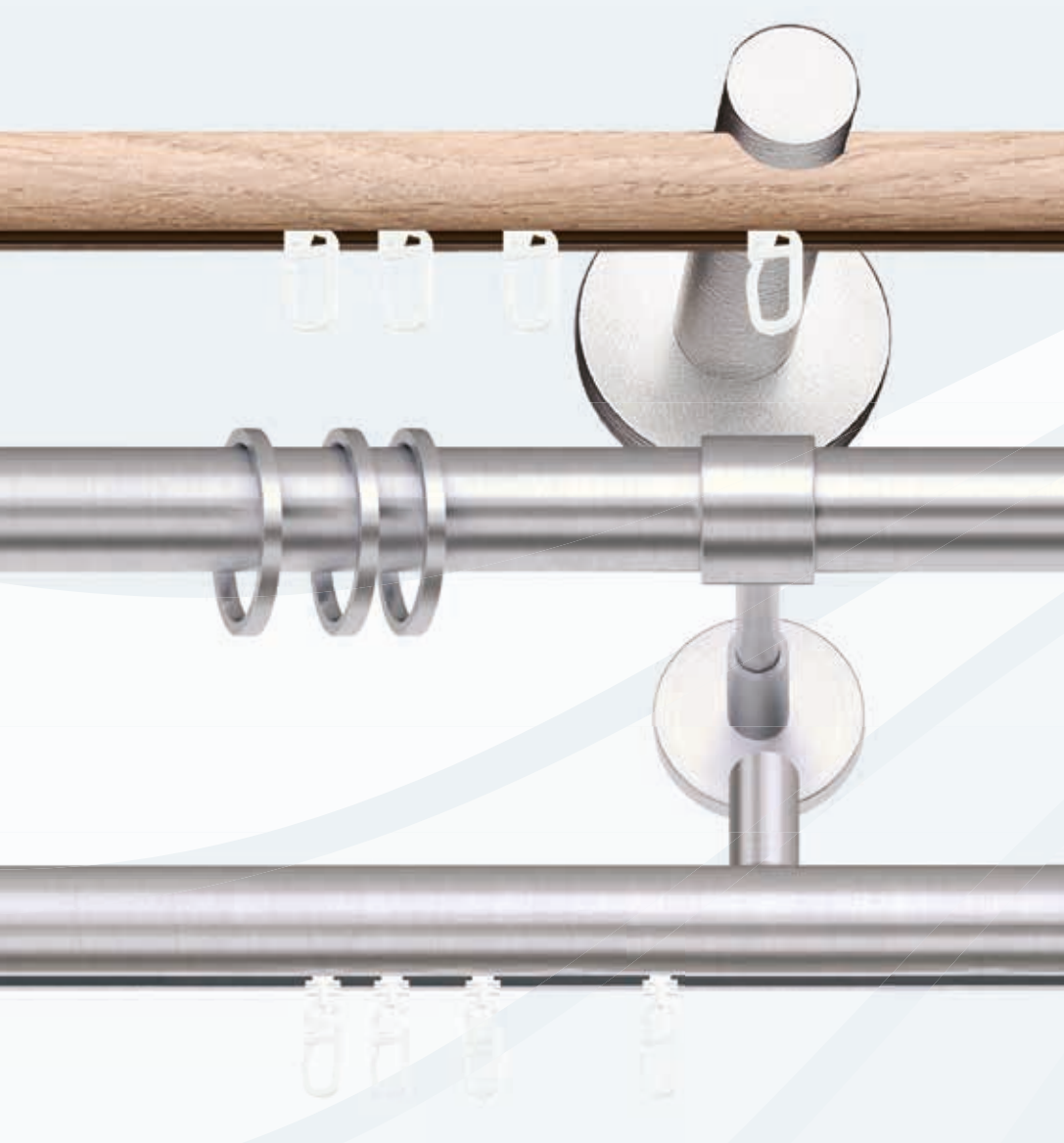

Edelstahl
Ø28

Träger-
systeme

Edelstahl Ø28mm Trägersysteme

Edelstahl Ø28mm - Trägersysteme



Farben Zubehör



Seite 65

Farben Stangen



Seite 65

Farben Zubehör



Farben Stangen



Seite 69

Farben Zubehör & Stangen



Seite 69

Farben Zubehör & Stangen





EDELSTAHL

Ø28



mit KLIXI Drehgleiter

Erkerausführung



Biegung



Gehrung



Gelenk

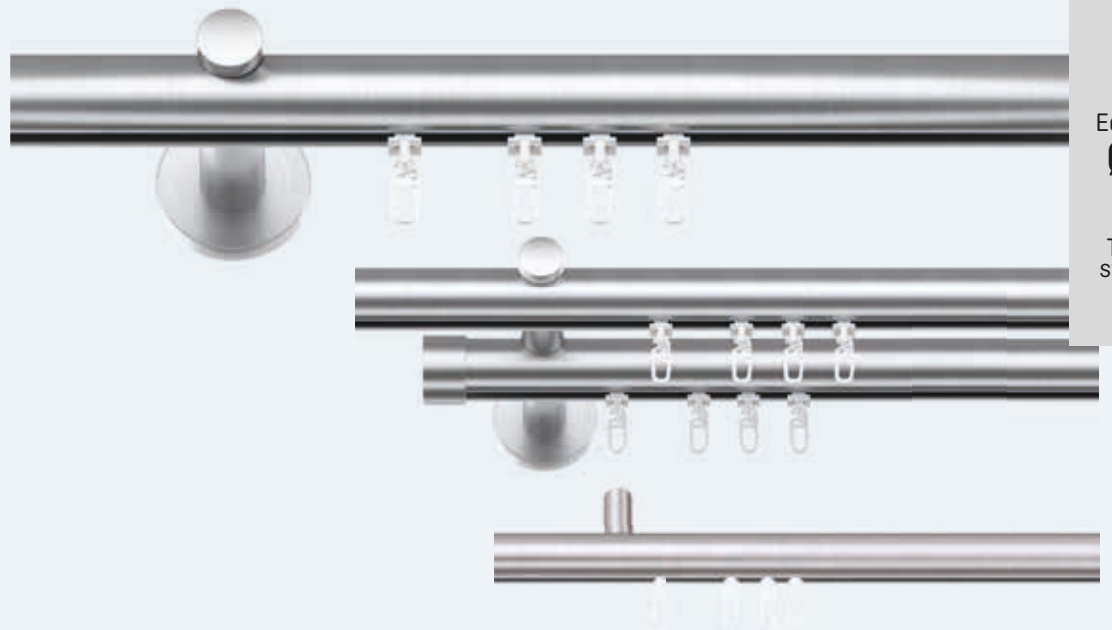

Edelstahl
Ø28

Träger-
systeme

Farben Zubehör



edelstahl

Farben Innenlauf-Profile



edelstahl



schwarz matt



wildeiche*



zwetschke*

* IL-Profile in wildeiche, zwetschke: Laufroller Art. 2420

Innenlauf-Wandträger Innenlauf-Deckenträger

Garnituren mit Innenlaufträgern ohne Endknöpfe



edelstahl
Maßstab 1:1



edelstahl
mit Deckenträger 871 077
Maßstab 1:1

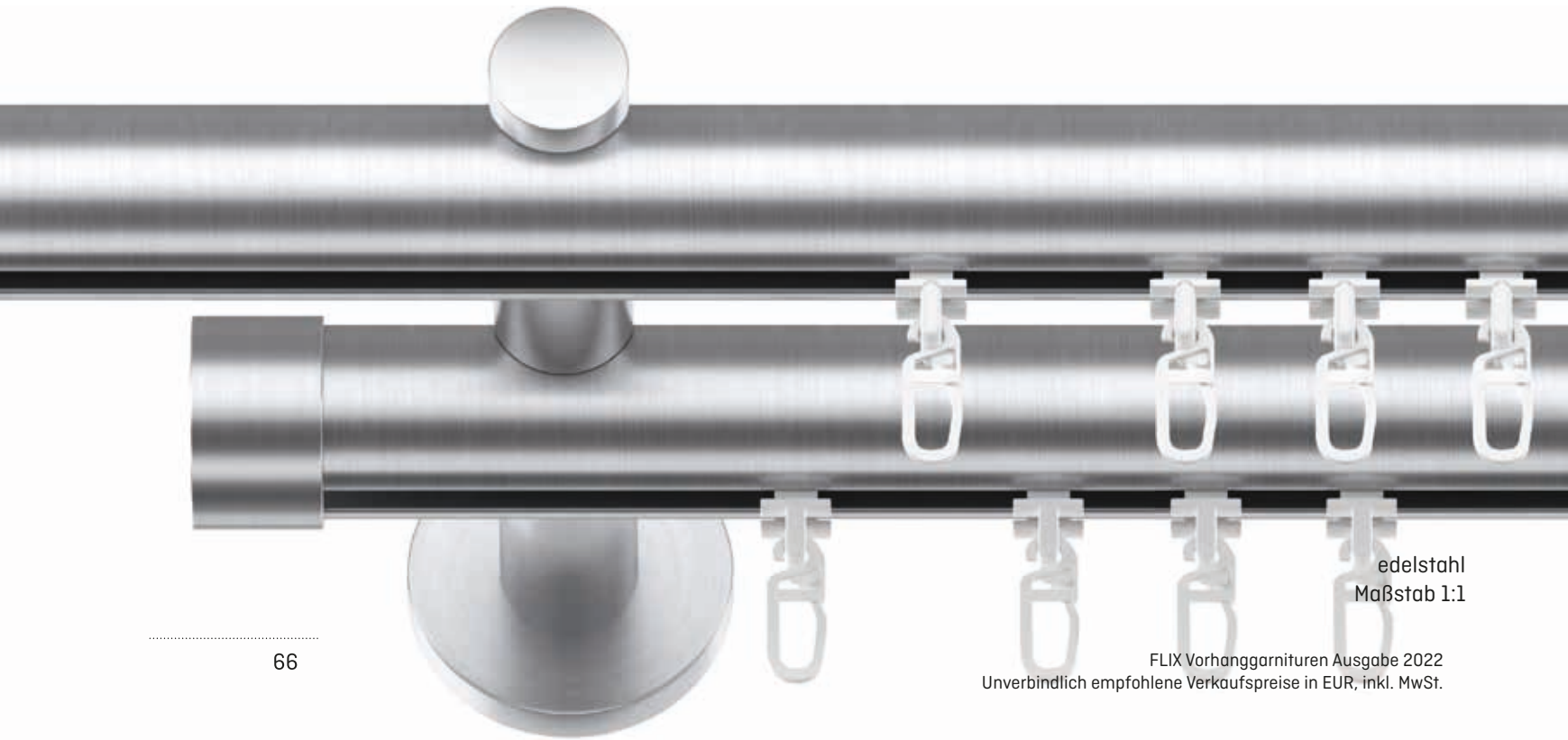

edelstahl
Maßstab 1:1

Lieferumfang

- ▶ **1 lfg:** 1 Alu Innenlauf-Profil Ø28mm oberflächenbehandelt, je nach Länge Wandträger und -Drehgleiter lt. Liste
- ▶ **2 lfg:** 2 Alu Innenlauf-Profile Ø28mm oberflächenbehandelt, je nach Länge Wandträger und -Drehgleiter lt. Liste, 2 Endkappen
- ▶ **1 lfg mit Deckenträger 15mm Deckenabstand**
- ▶ **1 lfg mit Deckenträger 35mm Deckenabstand**
- ▶ **1 lfg mit Deckenträger 43mm Deckenabstand**
- ▶ **Deckenträger:** 1 Alu Innenlauf-Profil Ø28mm oberflächenbehandelt, je nach Länge Deckenträger und -Drehgleiter lt. Liste

- ▶ mit Montagematerial
- ▶ Bestellmaß = Profilmaß
- ▶ Wandträger: Trägermitte bis Innenlaufprofil-Unterkante: 28mm
- ▶ Decke bis Innenlauf-Profilunterkante: siehe Maßskizzen
- ▶ bei geänderter Ausführung Aufpreis bzw. Preisänderung
- ▶ **IL-Profil in wildeiche, zwetschke: nur Laufroller Art. 2420 ohne Aufpreis**

Trägermaße

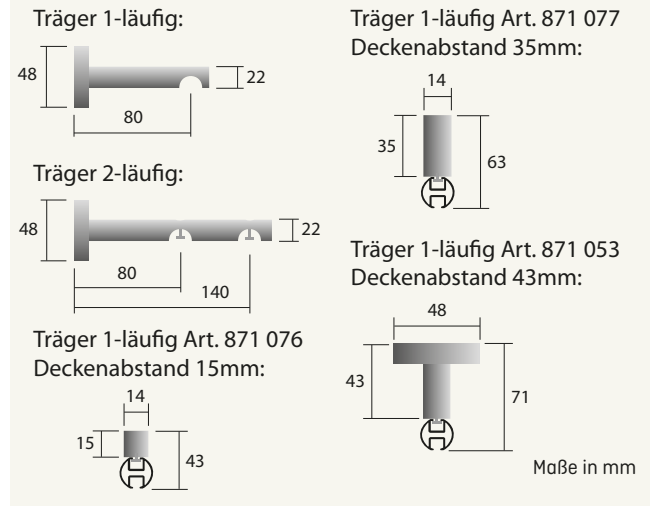

▶ **Aus produktionstechnischen Gründen bestehen geringfügige Farbabweichungen zwischen den Karniesenkomponenten.**

Edelstahl
Ø28

Träger-
systeme



			edelstahl					Preisänderung für IL-Profil in:	
			Wandträger		Deckenträger				
Bestellcode:			t28-068	t28-069	t28-316	t28-317	t28-318		
Länge (cm)	Wand-träger	Gleiter 1l./2l.	1lfg	2lfg	1lfg	1lfg	1lfg	1lfg	2lfg
100	2	16/32	148	266	101	106	135	0	0
120	2	18/36	160	289	113	118	147	0	0
140	2	22/44	172	312	125	130	159	0	0
160	2	26/52	184	335	137	142	171	0	0
180	2	28/54	196	358	149	154	183	0	0
200	2	32/64	208	381	161	166	195	0	0
220	2	34/68	220	404	173	178	207	0	0
240	3	38/76	274	484	204	211	254	0	0
260	3	42/84	286	507	216	223	266	0	0
280	3	44/88	298	530	228	235	278	0	0
300	3	48/96	310	553	240	247	290	0	0
320	3	50/100	322	576	252	259	302	0	0
340	3	54/108	334	599	264	271	314	0	0
360	3	58/116	346	622	276	283	326	0	0
380	3	60/120	358	645	288	295	338	0	0
400	3	64/128	370	668	300	307	350	0	0
+ 20 cm ▲		3/6	12	23	12	12	12	-	-
Preisänderung bei Wandlager	1-seitig		-1,30	+11,90	-	-	-		
	2-seitig		-2,60	+23,70	-	-	-		

- wildeiche
- zwetschke
- schwarz matt

▲ ab einer Länge von ca. 420 cm bzw. bei schwereren Vorhängen wird ein weiterer Träger empfohlen (Aufpreis)

Träger kürzen: 19,-/Stück

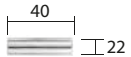

Träger und passende Verlängerungen			
Wandträger 1lfg - Wandabstand 80mm Stück			
	edelstahl	871 058 e	44,80
Wandträger 2lfg - Wandabstand 80/140mm Stück			
	edelstahl	871 143 e	55,40
Trägerverlängerung 40mm Stück			
	edelstahl	871 147 e	19,20

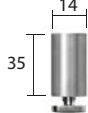
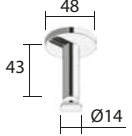
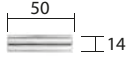
Träger und passende Verlängerungen			
Deckenträger, Deckenabstand 15mm Stück			
	edelstahl	871 076 e	21,60
Deckenträger, Deckenabstand 35mm Stück			
	edelstahl	871 077 e	24,-
Deckenträger 1lfg., Deckenabstand 43mm/Ø14mm Stück			
	edelstahl	871 053 e	34,80
Trägerverlängerung 50mm Stück			
	edelstahl	810 735 e	16,80

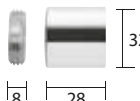
Deckenträger kürzbar - Deckenabstand 42-500mm Stück			
	edelstahl	871 084 e	57,60
Endkappe Ø28mm Stück			
	edelstahl	830 028 e	18,-
Endkappe flächenbündig Anna Ø28mm Stück			
	edelstahl	831 428 e	26,40
Wandlager Ø28mm Stück			
	edelstahl	82 328 e	39,60

Alu Innenlauf-Profil Ø28mm, Stange 6m			Meter
	edelstahl	n90 628 e	55,20
	wildeiche	n90 628 wi	55,20
	zwetschke	n90 628 zw	55,20
	schwarz matt	n90 628 sm	52,40

Profilverbinder Messing			Stück
	vernickelt	904 071	12,-

Profilverbinder Messing, beliebiger Winkel			Stück
	vernickelt	904 072 - bw	28,80

Gehungsschnitt (ohne Profilverbinder)			Gehrung
	90°	1bg-1gs-90	20,-
	beliebiger Winkel	1bg-1gs-bw	49,-

KLIXI-Drehgleiter 100 Stück			Beutel
	Kunststoff grau	2400 100 g	12,-
	Kunststoff weiß	2400 100 w	12,-

Gleiter 100 Stück			Beutel
	Kunststoff weiß	3942 100	5,40

Ösengleiter 100 Stück			Beutel
	Kunststoff weiß	3910 100	9,90

Gardinen-Einfachhaken 100 Stück			Beutel
	Kunststoff weiß	601 100	6,50

Gardinen-Doppelhaken 100 Stück			Beutel
	Kunststoff weiß	605 100	11,-

Roller mit Faltenleghaken			Stück
	Kunststoff weiß	2420	0,20

Roller mit Kugellager			Stück
	Kunststoff	904 074	1,10

 Biegungen siehe Gruppe 10

Erker Ausführung



Biegung



Gehrung



Gelenk

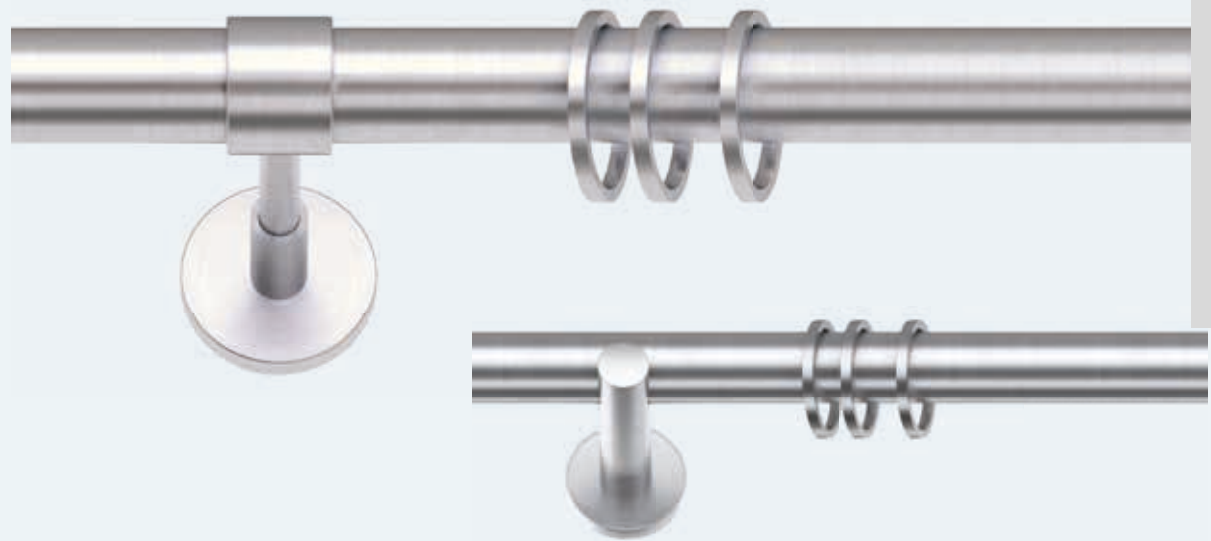

Edelstahl
Ø28

Träger-
systeme

Farben Zubehör & Stangen



edelstahl

Geschlossene Wandträger Glatt Offene Wandträger Rund

Garnituren ohne Endknöpfe

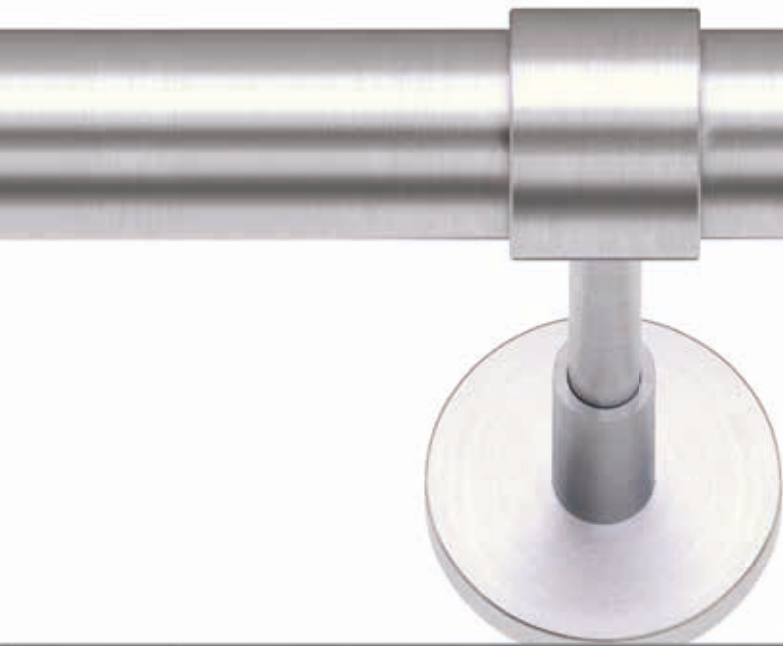

Garnituren mit Geschlossene Wandträger Glatt



edelstahl
Maßstab 1:1

Garnituren mit Offene Wandträger Rund

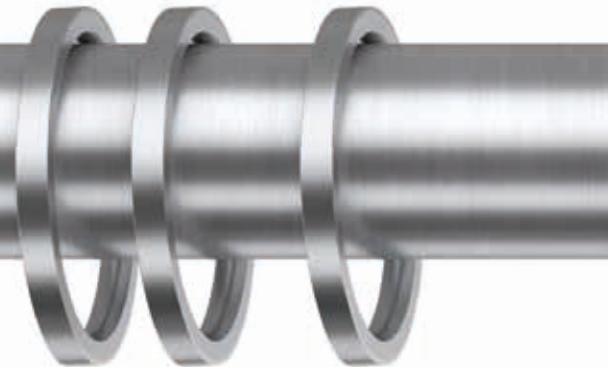

edelstahl
Maßstab 1:1

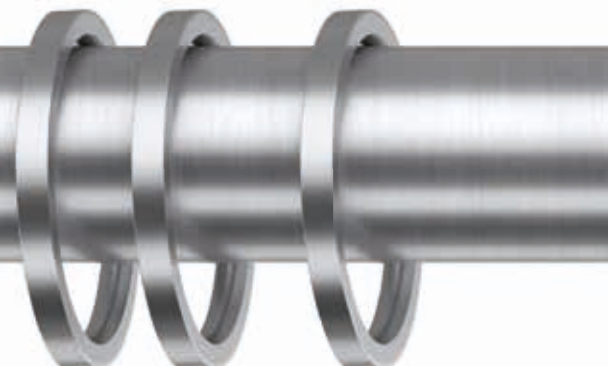

edelstahl
Maßstab 1:1

Lieferumfang

- ▶ **1 lfg:** 1 Edelstahl-Rohr Ø28mm oberflächenbehandelt, je nach Länge Wandträger und Ringe mit Faltenleghaken lt. Liste
- ▶ **2 lfg:** 2 Edelstahl-Rohre Ø28mm oberflächenbehandelt, je nach Länge Wandträger und Ringe mit Faltenleghaken lt. Liste, 2 Endkappen

- ▶ mit Montagematerial
- ▶ Bestellmaß = Rohrmaß
- ▶ Trägermitte bis Ringunterkante: 32mm
- ▶ bei geänderter Ausführung Aufpreis bzw. Preisänderung
- ▶ **Aus produktionstechnischen Gründen bestehen geringfügige Farbabweichungen zwischen den Karniesenkomponenten.**

Trägermaße

Träger 1-läufig:

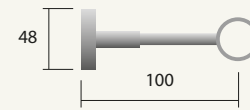

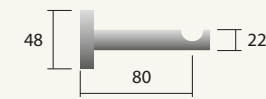

Träger 1-läufig:

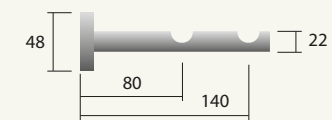

Träger 2-läufig:



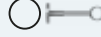

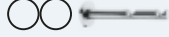
Maße in mm

			 edelstahl		
Bestellcode:			t28-066	t28-071	t28-072
Länge (cm)	Wand-träger	Ringe/Gleiter	1lfg 	1lfg 	2lfg 
100	2	14/16	217	180	332
120	2	16/18	235	198	368
140	2	20/22	253	216	404
160	2	22/26	271	234	440
180	2	24/28	289	252	476
200	2	28/32	307	270	512
220	2	30/34	325	288	548
240	3	34/38	409	353	643
260	3	36/42	427	371	679
280	3	38/44	445	389	715
300	3	42/48	463	407	751
320	3	44/50	481	425	787
340	3	48/54	499	443	823
360	3	50/58	517	461	859
380	3	52/60	535	479	895
400	3	56/64	553	497	931
+ 20cm	▲	3/6	18	18	36
Preisänderung bei Wandlager	1-seitig		-19,80	-1	+12
	2-seitig		-39,60	-3	+24

▲ ab einer Länge von ca. 420 cm bzw. bei schwereren Vorhängen wird ein weiterer Träger empfohlen (Aufpreis)

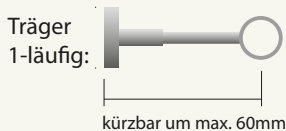
Träger kürzen: 19,-/Stück

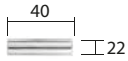

Träger und passende Verlängerungen				
Wandträger 1lfg - Wandabstand 80mm Stück				
	edelstahl	871 059 e	44,80	
Wandträger 2lfg - Wandabstand 80/140mm Stück				
	edelstahl	871 146 e	55,40	
Trägerverlängerung 40mm Stück				
	edelstahl	871 147 e	19,20	

Träger und passende Verlängerungen				
Wandträger 1lfg - Wandabstand 100mm Stück				
	edelstahl	810 729 e	57,60	
Trägerverlängerung 50mm Stück				
	edelstahl	810 735 e	16,80	

Endkappe Ø28mm				
	edelstahl	830 028 e	18,-	

Wandlager Ø28mm				
	edelstahl	82 328 e	39,60	

Edelstahlrohr, Ø28mm, Stange 6m				
	edelstahl	es 2810	45,50	

Rohrverbinder Ø28mm				
	Metall/Kunststoff	1728	15,60	

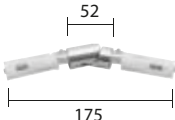
Gelenkverbinder Ø28mm				
	edelstahl	8928 e	78,-	

Flachring Ø28mm mit Kunststoffeinlage + FH				
	nickel matt	848 281 n	4,90	

Flachring Ø28mm + FH				
	edelstahl	847 281 e	2,80	

Faltenleghaken				
	Kunststoff glasklar	36003 gk	0,10	



Messing

Messing Ø16 mm

Übersicht	Seite 76
Endknöpfe	Seite 77
Innenlauf-Wandträger	Seite 83
Innenlauf-Deckenträger	Seite 83
Offene Wandträger Rund	Seite 87

Messing Ø20 mm

Übersicht	Seite 92
Endknöpfe	Seite 93
Innenlauf-Wandträger	Seite 103
Innenlauf-Deckenträger	Seite 107
Offene Wandträger Glatt	Seite 111
Offene Wandträger Rund	Seite 115
Offene Wandträger Rund, Storeschiene mit Alu-Innenlauf Profil	Seite 115
Offene Wandträger Glatt, Storeschiene mit Alu-Innenlauf Profil	Seite 119
Geschlossene Wandträger Rund	Seite 123

Messing Ø28 mm

Übersicht	Seite 128
Endknöpfe	Seite 129
Innenlauf-Wandträger	Seite 143
Innenlauf-Deckenträger	Seite 147
Offene Wandträger Glatt	Seite 151
Offene Wandträger Glatt, Storeschiene mit Alu-Innenlauf Profil	Seite 155
Geschlossene Wandträger Rund	Seite 159

flIX

Ø16



Messing
Ø16

Messing Ø16mm

Messing Ø16mm - Trägersysteme

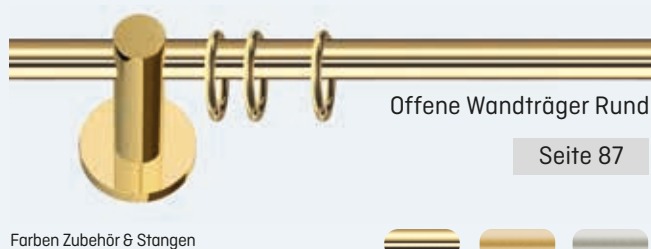

Messing Ø16mm - Endknöpfe





Anna
FLÄCHENBÜNDIG

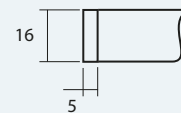

Alassio

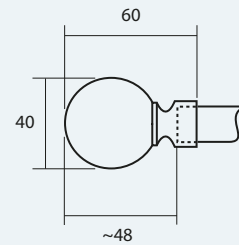

Sabine

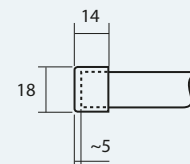

Endknöpfe Messing Ø16 mm

Anna

FLÄCHENBÜNDIG

Endknopf Anna		Stück
poliert lackiert	831 416 p	25,20
messing matt	831 416 m	25,20
nickel matt	831 416 n	25,20

messing matt nickel matt

poliert lackiert
Maßstab 1:1

Alassio

Endknopf Alassio		Stück
poliert lackiert	830 116 p	62,40
messing matt	830 116 m	62,40
nickel matt	830 116 n	62,40

poliert lackiert nickel matt

messing matt
Maßstab 1:1

Sabine

Endknopf Sabine		Stück
poliert lackiert	830 016 p	18,-
messing matt	830 016 m	18,-
nickel matt	830 016 n	18,-

poliert lackiert nickel matt

messing matt
Maßstab 1:1

Leichte Farbunterschiede zwischen Stange, Endknöpfen und Wandträger können aus produktionstechnischen Gründen auftreten.



Globe

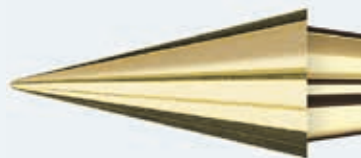
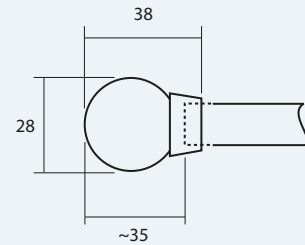

Pulko

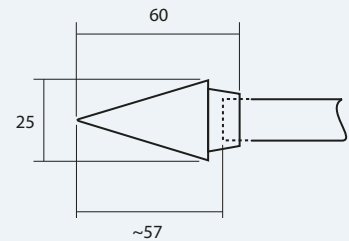

Endknöpfe Messing Ø16 mm

Globe





messing matt



nickel matt



poliert lackiert
Maßstab 1:1

Endknopf Globe		Stück
poliert lackiert	 831 116 p	49,-
messing matt	 831 116 m	49,-
nickel matt	 831 116 n	49,-

Pulko





nickel matt



messing matt



poliert lackiert
Maßstab 1:1

Endknopf Pulko		Stück
poliert lackiert	 831 216 p	49,-
messing matt	 831 216 m	49,-
nickel matt	 831 216 n	49,-

Leichte Farbunterschiede zwischen Stange, Endknöpfen und Wandträger können aus produktionstechnischen Gründen auftreten.



Ø16

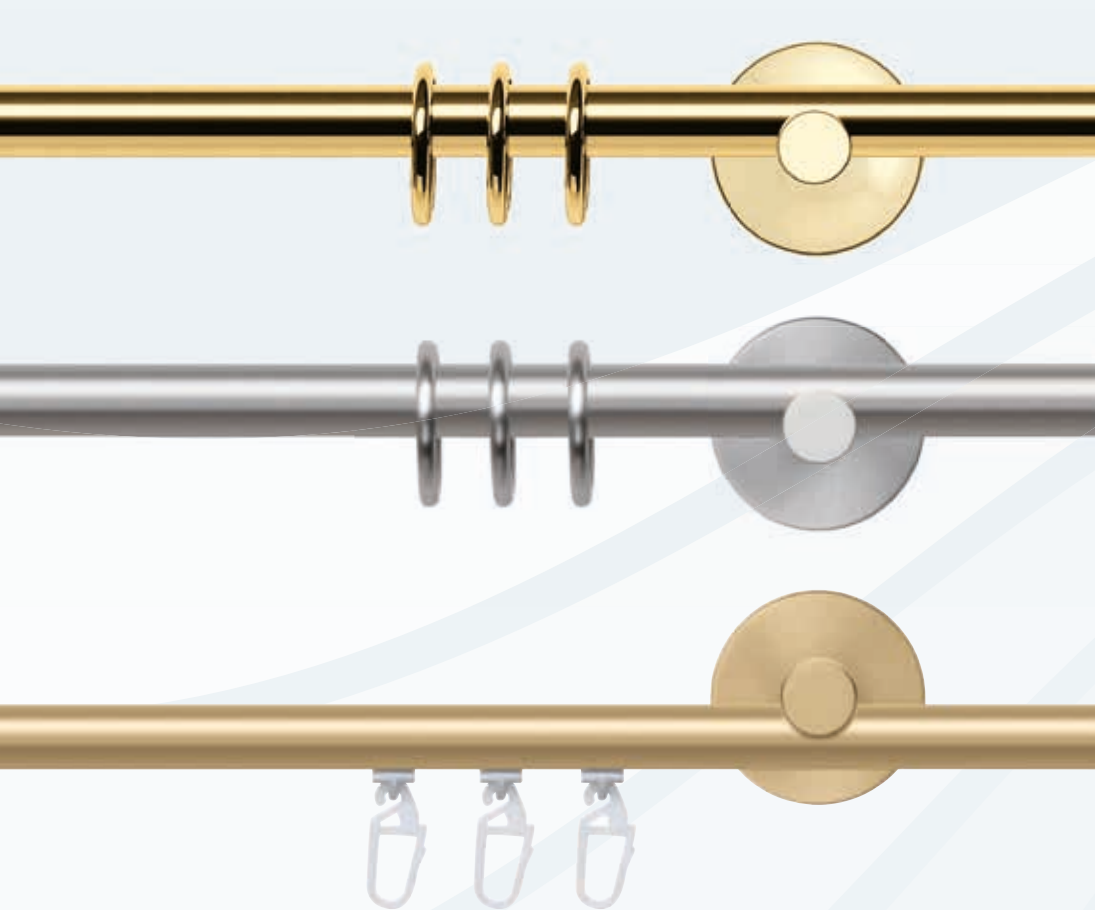

Messing
Ø16

Träger-
systeme

Messing Ø16mm Trägersysteme

Messing Ø16mm - Trägersysteme

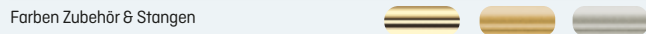
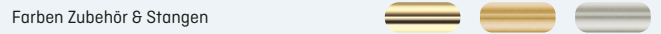
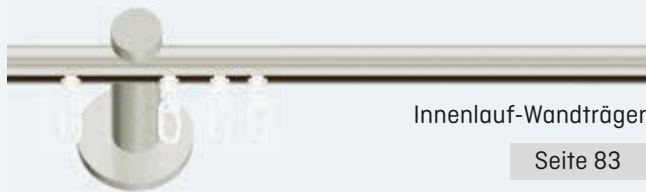



mit KLIXI
Drehgleiter

Erkerausführung



Biegung



Gehrung



Gelenk

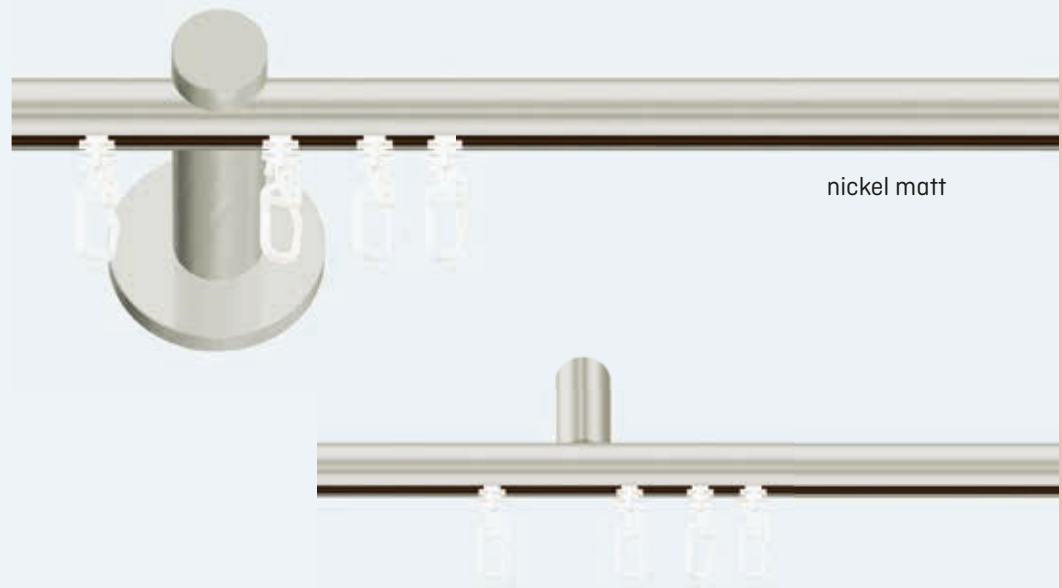

nickel matt

Messing
Ø16

Träger-
systeme

Farben Zubehör



poliert lackiert



messing matt



nickel matt

Farben Stangen



poliert lackiert



messing matt



nickel matt

Innenlauf-Wandträger Innenlauf-Deckenträger

Garnituren mit Innenlaufträgern ohne Endknöpfe

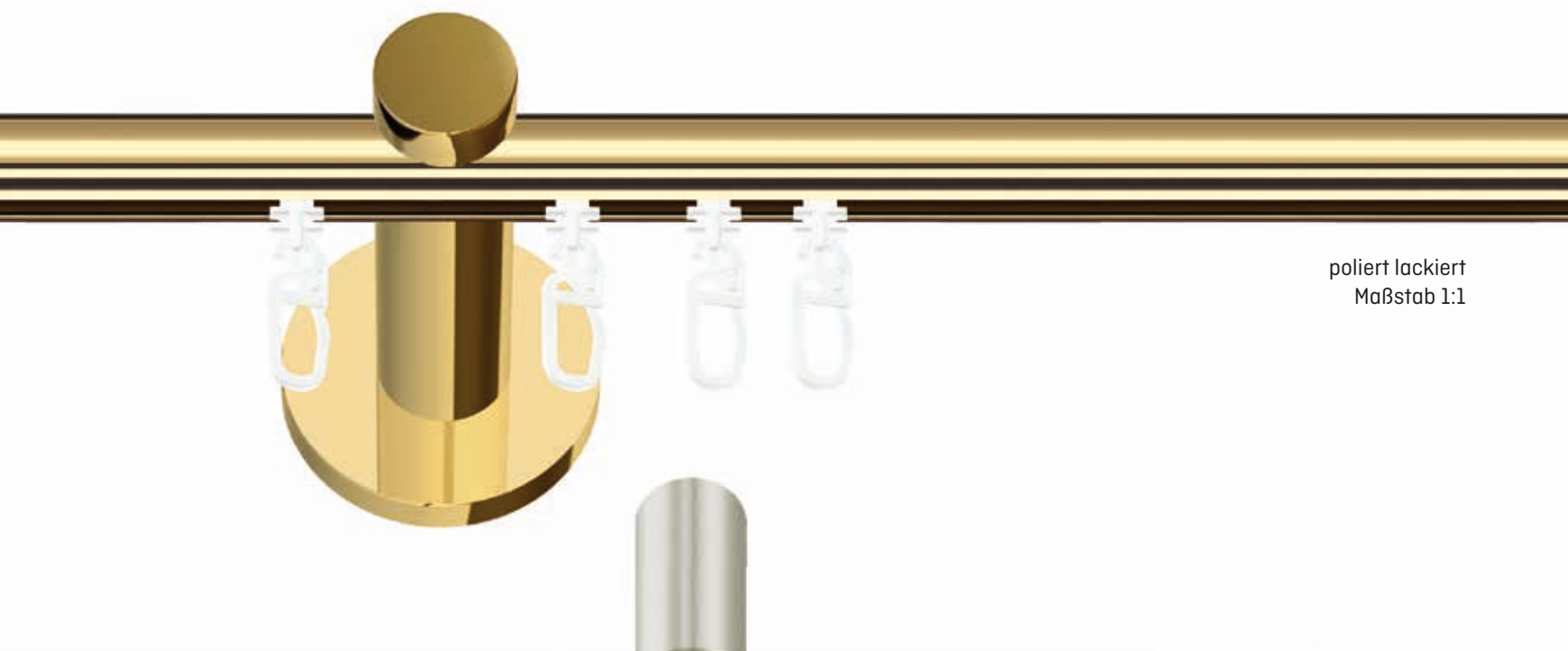

poliert lackiert
Maßstab 1:1





nickel matt
mit Deckenträger 871 077
Maßstab 1:1



poliert lackiert
Maßstab 1:1

Lieferumfang

- ▶ **1 lfg:** 1 Alu Innenlauf-Profil Ø16mm oberflächenbehandelt, je nach Länge Wandträger und -Drehgleiter lt. Liste
- ▶ **1 lfg mit Deckenträger 15mm Deckenabstand**
- ▶ **1 lfg mit Deckenträger 35mm Deckenabstand**
- ▶ **1 lfg mit Deckenträger 43mm Deckenabstand**
- ▶ **Deckenträger:** 1 Alu Innenlauf-Profil Ø16mm oberflächenbehandelt, je nach Länge Deckenträger und -Drehgleiter lt. Liste

- ▶ mit Montagematerial
- ▶ Bestellmaß = Profilmaß
- ▶ Wandträger: Trägermitte bis Stangenunterkante: 16mm
- ▶ Decke bis Innenlauf-Profilunterkante: siehe Maßskizzen
- ▶ bei geänderter Ausführung Aufpreis bzw. Preisänderung
- ▶ **Aus produktionstechnischen Gründen bestehen geringfügige Farbabweichungen zwischen den Karnisenkomponenten.**

Trägermaße

Träger 1-läufig:

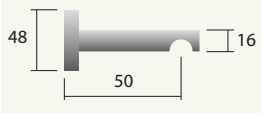

Träger 1-läufig Art. 871 076
Deckenabstand 15mm:

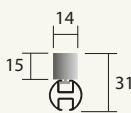

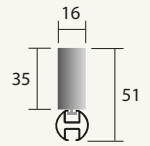

Träger 1-läufig Art. 871 077
Deckenabstand 35mm:

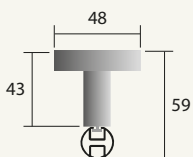

Träger 1-läufig Art. 871 053
Deckenabstand 43mm:



Maße in mm

														
Bestellcode:			t16-028	t16-320	t16-321	t16-322	t16-038	t16-323	t16-324	t16-325	t16-042	t16-326	t16-327	t16-328
Länge (cm)	Wand-träger	Gleiter 1l.	1lfg	1lfg	1lfg	1lfg	1lfg	1lfg	1lfg	1lfg	1lfg	1lfg	1lfg	1lfg
100	2	16	180	116	129	172	180	116	129	172	180	116	129	172
120	2	18	192	128	141	184	192	128	141	184	192	128	141	184
140	2	22	204	140	153	196	204	140	153	196	204	140	153	196
160	2	26	216	152	165	208	216	152	165	208	216	152	165	208
180	3	28	288	193	212	276	288	193	212	276	288	193	212	276
200	3	32	300	205	224	288	300	205	224	288	300	205	224	288
220	3	34	312	217	236	300	312	217	236	300	312	217	236	300
240	3	38	324	229	248	312	324	229	248	312	324	229	248	312
260	3	42	336	241	260	324	336	241	260	324	336	241	260	324
280	3	44	348	253	272	336	348	253	272	336	348	253	272	336
300	3	48	360	265	284	348	360	265	284	348	360	265	284	348
320	3	50	372	277	296	360	372	277	296	360	372	277	296	360
340	3	54	384	289	308	372	384	289	308	372	384	289	308	372
360	4	58	457	330	356	441	457	330	356	441	457	330	356	441
380	4	60	469	342	368	453	469	342	368	453	469	342	368	453
400	4	64	481	354	380	465	481	354	380	465	481	354	380	465
+ 20 cm	▲	3	12	12	12	12	12	12	12	12	12	12	12	12
Preisänderung bei Wandlager	1-seitig		-22,40				-22,40				-22,40			
	2-seitig		-44,80				-44,80				-44,80			

▲ ab einer Länge von ca. 500 cm bzw. bei schwereren Vorhängen wird ein weiterer Träger empfohlen (Aufpreis)

Träger kürzen: 19,-/Stück

Träger 1-läufig:



kürzbar um max. 11 mm

Messing
Ø16
Träger-systeme

Träger und passende Verlängerungen

Wandträger 1lfg - Wandabstand 50mm		Stück
	poliert lackiert	871 051 p 54,-
	nickel matt	871 051 n 54,-
	messing matt	871 051 m 54,-

Wandträger 1lfg - Wandabstand 80mm		Stück
	poliert lackiert	871 081 p 57,60
	nickel matt	871 081 n 57,60
	messing matt	871 081 m 57,60

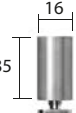
Deckenträger, Deckenabstand 35mm		Stück
	poliert lackiert	871 077 p 31,20
	nickel matt	871 077 n 31,20
	messing matt	871 077 m 31,20

Deckenträger 1lfg., Deckenabstand 43mm/Ø16mm		Stück
	poliert lackiert	871 053 p 50,40
	nickel matt	871 053 n 50,40
	messing matt	871 053 m 50,40

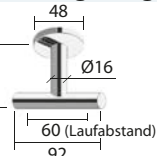
Deckenträger 2lfg., Deckenabstand 53mm/Ø16mm		Stück
	poliert lackiert	871 153 p 81,60
	nickel matt	871 153 n 81,60
	messing matt	871 153 m 81,60

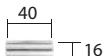
Trägerverlängerung für Wand-/Deckenträger, 40mm		Stück
	poliert lackiert	871 044 p 21,60
	nickel matt	871 044 n 21,60
	messing matt	871 044 m 21,60

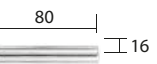
Trägerverlängerung für Wand-/Deckenträger, 80mm		Stück
	poliert lackiert	871 066 p 24,-
	nickel matt	871 066 n 24,-
	messing matt	871 066 m 24,-

Deckenträger, Deckenabstand 15mm		Stück
	poliert lackiert	871 076 p 25,20
	nickel matt	871 076 n 25,20
	messing matt	871 076 m 25,20

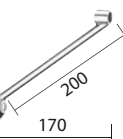
Trägerstütze		Stück
	poliert lackiert	810 7291 p 55,20
	nickel matt	810 7291 n 55,20
	messing matt	810 7291 m 55,20

Endkappe Ø16mm		Stück
	poliert lackiert	830 016 p 18,-
	nickel matt	830 016 n 18,-
	messing matt	830 016 m 18,-

Endkappe flächenbündig Anna Ø16mm		Stück
	poliert lackiert	831 416 p 25,20
	nickel matt	831 416 n 25,20
	messing matt	831 416 m 25,20

Wandlager Ø16mm		Stück
	poliert lackiert	82 316 p 33,60
	nickel matt	82 316 n 33,60
	messing matt	82 316 m 33,60

Alu Innenlauf-Profil Ø16mm, Stange 6mm		Meter
	poliert lackiert	n90 616 p 58,-
	nickel matt	n90 616 n 58,-
	messing matt	n90 616 m 58,-

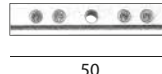
Profilverbinder Messing		Stück
	vernickelt	904 071 12,-

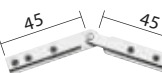
Profilverbinder Messing, beliebiger Winkel		Stück
	vernickelt	904 072 - bw 28,80

Gehungsschnitt (ohne Profilverbinder)		Gehrung
	90°	1bg-1gs-90 20,-
	beliebiger Winkel	1bg-1gs-bw 49,-

KLIXI-Drehgleiter 100 Stück		Beutel
	Kunststoff weiß	2400 100 w 12,-

Gleiter 100 Stück		Beutel
	Kunststoff weiß	3942 100 5,40

Ösengleiter 100 Stück		Beutel
	Kunststoff weiß	3910 100 9,90

Gardinen-Einfachhaken 100 Stück		Beutel
	Kunststoff weiß	601 100 6,50

Gardinen-Doppelhaken 100 Stück		Beutel
	Kunststoff weiß	605 100 11,-

 Biegungen siehe Gruppe 10



mit Rohren aus
Reinmessing

Erkerausführung



Biegung



Gehrung



Gelenk

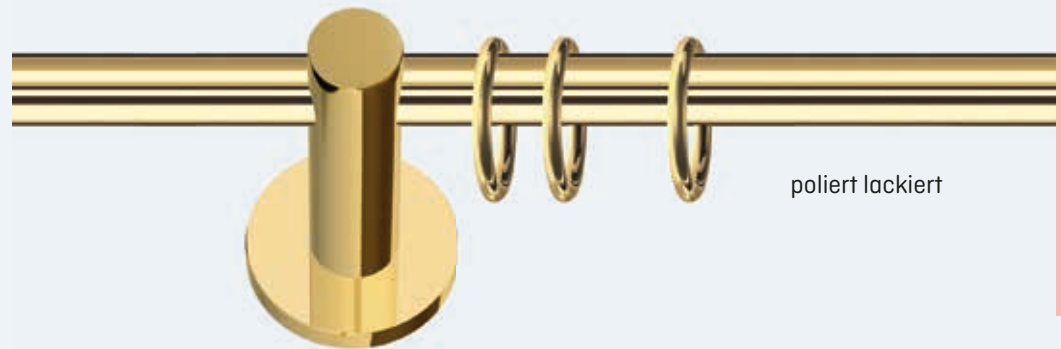

Messing
Ø16

Träger-
systeme

Farben Zubehör & Stangen



poliert lackiert



messing matt



nickel matt

Offene Wandträger Rund

Garnituren mit Offenen Wandträgern Rund ohne Endknöpfe

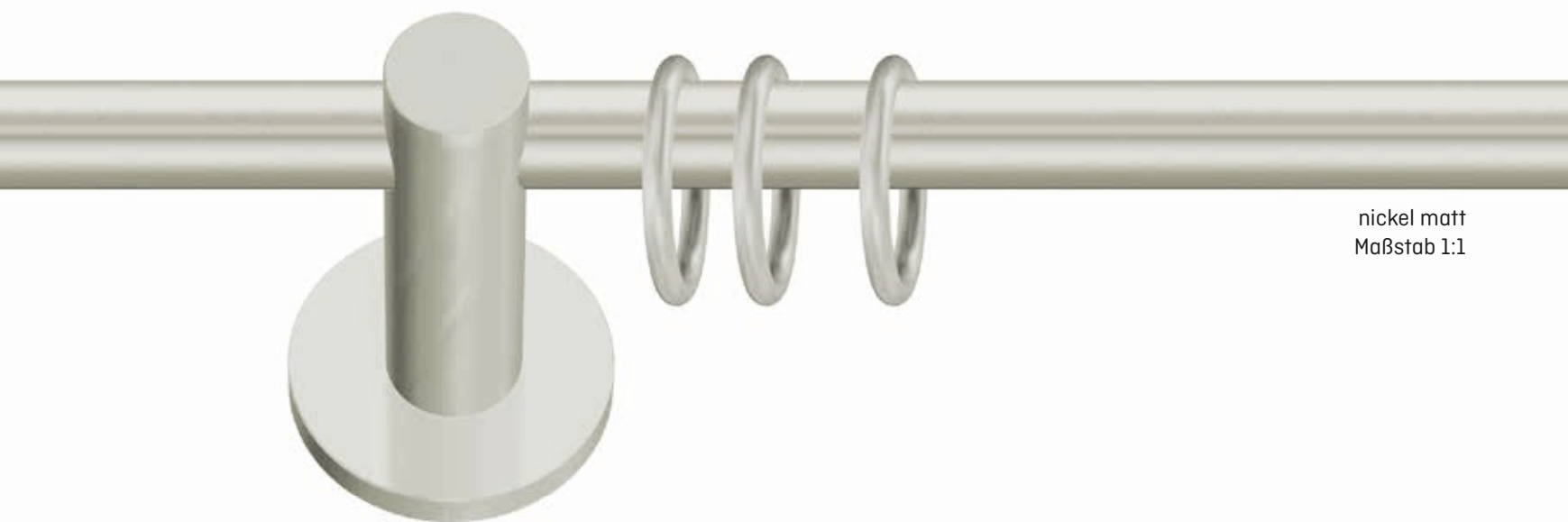

nickel matt
Maßstab 1:1

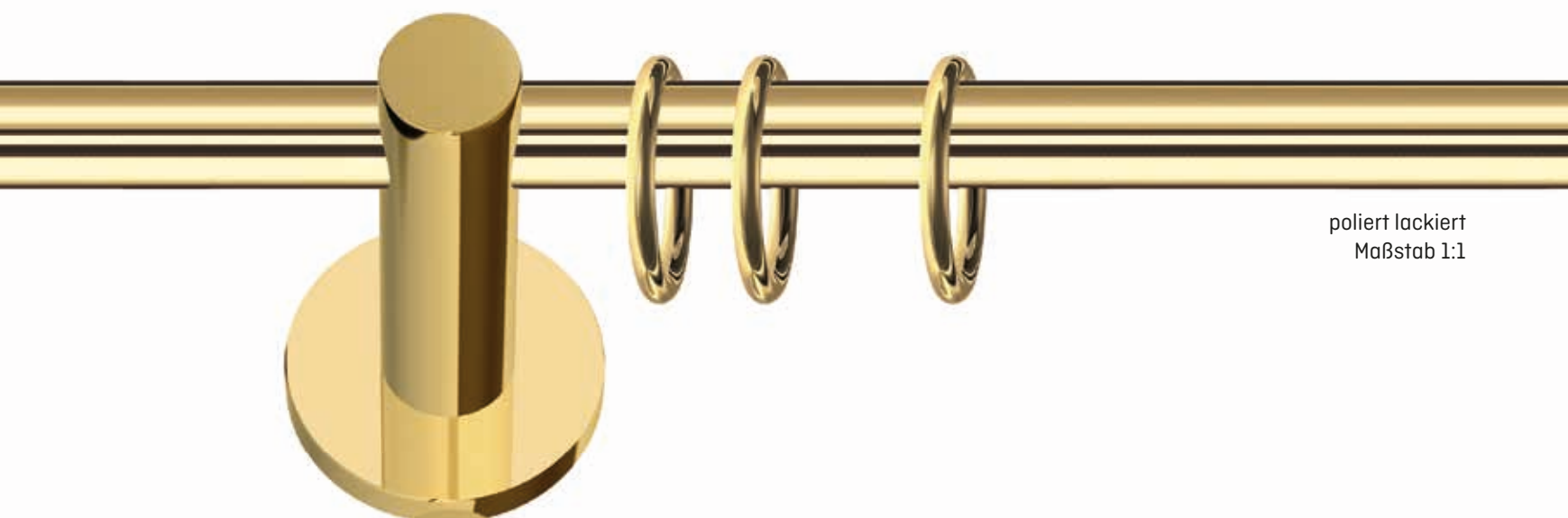

poliert lackiert
Maßstab 1:1

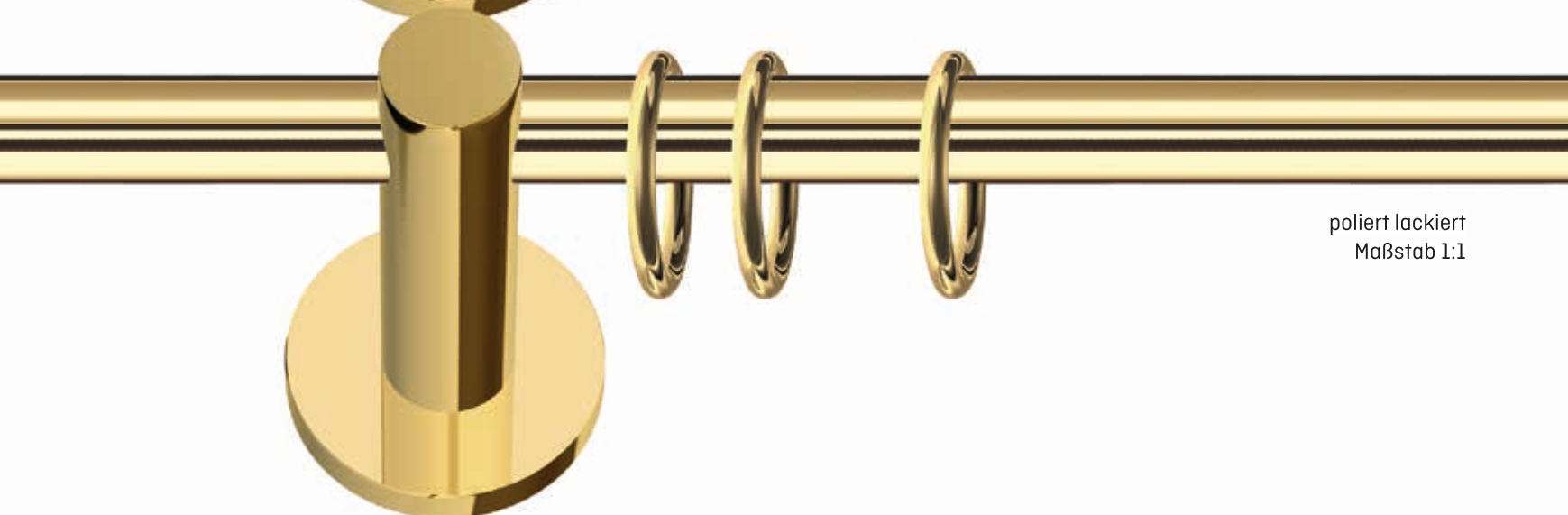

poliert lackiert
Maßstab 1:1

Lieferumfang



- ▶ **1 lfg:** 1 Reimessing-Rohr Ø16mm oberflächenbehandelt, je nach Länge Wandträger und Ringe mit Faltenleghaken lt. Liste
- ▶ mit Montagmaterial
- ▶ Bestellmaß = Rohrmaß
- ▶ Trägermitte bis Ringunterkante: 18mm
- ▶ bei geänderter Ausführung Aufpreis bzw. Preisänderung
- ▶ **Aus produktionstechnischen Gründen bestehen geringfügige Farbabweichungen zwischen den Karniesenkomponenten.**

Trägermaße

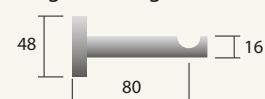
Träger 1-läufig:



Maße in mm

					
Bestellcode:			t16-024	t16-018	t16-022
Länge (cm)	Wand-träger	Ringe 1l.	1lfg ○	1lfg ○	1lfg ○
100	2	14	176	189	180
120	2	16	188	203	193
140	2	20	200	217	206
160	2	22	212	231	219
180	3	24	280	302	286
200	3	28	292	316	299
220	3	30	304	330	312
240	3	34	316	344	325
260	3	36	328	358	338
280	3	38	340	372	351
300	3	42	352	386	364
320	3	44	364	400	377
340	3	48	376	414	390
360	4	50	452	494	463
380	4	52	464	508	476
400	4	56	476	522	489
+ 20cm	▲	3	12	14	13
Preisänderung bei Wandlager	1-seitig		-23,60	-24,10	-24,10
	2-seitig		-47,10	-48,20	-48,20

▲ ab einer Länge von ca. 500 cm bzw. bei schwereren Vorhängen wird ein weiterer Träger empfohlen (Aufpreis)

Träger kürzen: 19,-/Stück

Träger 1-läufig:





kürzbar um max. 30 mm

Messing
Ø16

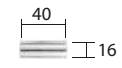
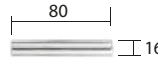
Träger-
systeme

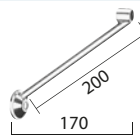
Träger und passende Verlängerungen			
Wandträger 1lfg - Wandabstand 80mm			
	poliert lackiert	815 116 p	57,60
	nickel matt	815 116 n	57,60
	messing matt	815 116 m	57,60
Trägerverlängerung für Wand-/Deckenträger, 40mm			
	poliert lackiert	871 044 p	21,60
	nickel matt	871 044 n	21,60
	messing matt	871 044 m	21,60
Trägerverlängerung für Wand-/Deckenträger, 80mm			
	poliert lackiert	871 066 p	24,-
	nickel matt	871 066 n	24,-
	messing matt	871 066 m	24,-

Trägerstütze			
	poliert lackiert	810 7291 p	55,20
	nickel matt	810 7291 n	55,20
	messing matt	810 7291 m	55,20

Endkappe Ø16mm			
	poliert lackiert	830 016 p	18,-
	nickel matt	830 016 n	18,-
	messing matt	830 016 m	18,-

Wandlager Ø16mm			
	poliert lackiert	82 316 p	33,60
	nickel matt	82 316 n	33,60
	messing matt	82 316 m	33,60

Ring Ø20mm + FH			
	poliert lackiert	840 201 p	2,90
	nickel matt	840 201 n	2,90
	messing matt	840 201 m	2,90

Flachring Ø20mm mit Kunststoffeinlage + FH			
	poliert lackiert	848 201 p	3,60
	nickel matt	848 201 n	3,60
	messing matt	848 201 m	3,60

Messingrohr, Ø16mm, Stange 5m			Meter
	poliert lackiert	ms 1607 p	50,40
	nickel matt	ms 1607 n	50,40
	messing matt	ms 1607 m	50,40

Rohrverbinder Ø16mm			Stück
	Metall/Kunststoff	1716	13,20

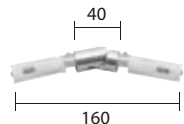
Gelenkverbinder Ø16mm			Stück
	poliert lackiert	8916 p	62,40
	nickel matt	8916 n	62,40
	messing matt	8916 m	62,40

Faltenleghaken für Flachring			Stück
	Kunststoff glasklar	36003 gk	0,10

Faltenleghaken für Ring			Stück
	Kunststoff glasklar	36006 gk	0,10

flIX

Ø20



Messing
Ø20

Messing Ø20mm

Messing Ø20mm - Trägersysteme



Innenlauf-Wandträger
Seite 103

Farben Zubehör: 

Farben Stangen: 



Innenlauf-Deckenträger
Seite 107

Farben Zubehör: 

Farben Stangen: 

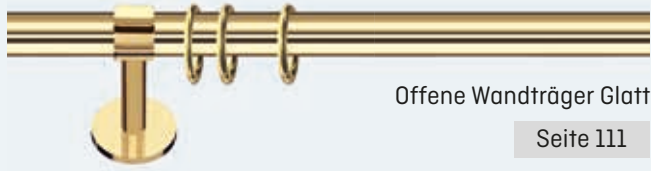

Offene Wandträger Glatt
Seite 111

Farben Zubehör & Stangen: 



Offene Wandträger Rund
Seite 115

Farben Zubehör & Stangen: 



**Offene Wandträger Glatt
Storeschiene mit Alu Innenlauf Profil**
Seite 119

Farben Zubehör & Stangen: 



**Offene Wandträger Rund
Storeschiene mit Alu Innenlauf Profil**
Seite 115











Farben Zubehör & Stangen: 

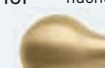

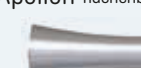
Geschlossene Wandträger Rund
Seite 123

Farben Zubehör & Stangen: 

Messing Ø20mm - Endknöpfe

<p>Anna flächenbündig</p>  <p>Seite 93</p>	<p>Olymp flächenbündig</p>  <p>Seite 93</p>	<p>Thor flächenbündig</p>  <p>Seite 93</p>	<p>Strass</p>  <p>Seite 95</p>	<p>Apollon flächenbündig</p>  <p>Seite 95</p>	<p>Imperia</p>  <p>Seite 97</p>
<p>Katja</p>  <p>Seite 97</p>	<p>Alassio</p>  <p>Seite 97</p>	<p>Cremona</p>  <p>Seite 99</p>	<p>Lisa</p>  <p>Seite 99</p>	<p>Sabine</p>  <p>Seite 99</p>	



Anna
FLÄCHENBÜNDIG

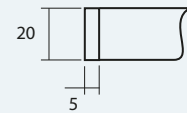

Olymp
FLÄCHENBÜNDIG

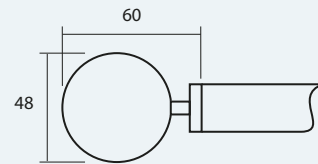

Thor
FLÄCHENBÜNDIG

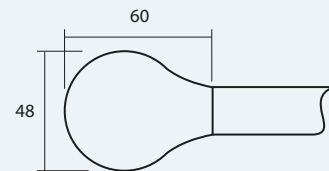

Messing
Ø20

Endknöpfe Messing Ø20 mm

Anna

FLÄCHENBÜNDIG



Endknopf Anna		Stück
poliert lackiert	831 420 p	28,80
verchromt	831 420 v	28,80
messing matt	831 420 m	28,80
nickel matt	831 420 n	28,80

Olymp

FLÄCHENBÜNDIG



poliert lackiert



nickel matt



messing matt



Endknopf Olymp		Stück
poliert lackiert	834 720 p	96,-
verchromt	834 720 v	96,-
messing matt	834 720 m	96,-
nickel matt	834 720 n	96,-

Thor

FLÄCHENBÜNDIG



poliert lackiert



verchromt



nickel matt



Endknopf Thor		Stück
poliert lackiert	834 620 p	96,-
verchromt	834 620 v	96,-
messing matt	834 620 m	96,-
nickel matt	834 620 n	96,-

Leichte Farbunterschiede zwischen Stange, Endknöpfen und Wandträger können aus produktionstechnischen Gründen auftreten.



Strass

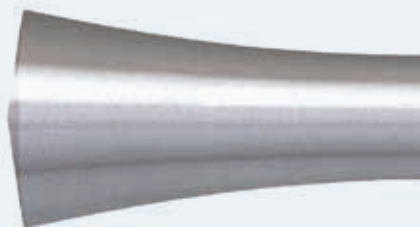
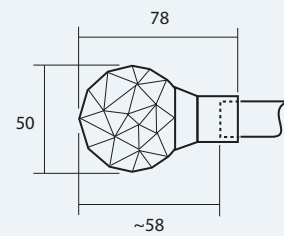

Apollon
FLÄCHENBÜNDIG

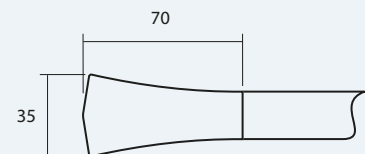

Messing
Ø20

Endknöpfe Messing Ø20 mm

Strass



verchromt



nickel matt



messing matt



poliert lackiert/
Strass-Kristall
Maßstab 1:1

Endknopf Strass		Stück
poliert lackiert	837 521 p	132,-
verchromt	837 521 v	134,40
messing matt	837 521 m	132,-
nickel matt	837 521 n	134,40

Apollon

FLÄCHENBÜNDIG



poliert lackiert



verchromt



messing matt

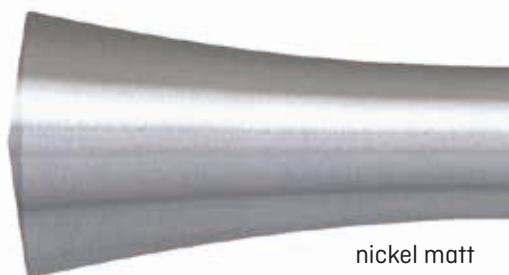

nickel matt
Maßstab 1:1

Endknopf Apollon		Stück
poliert lackiert	834 420 p	74,40
verchromt	834 420 v	74,40
messing matt	834 420 m	74,40
nickel matt	834 420 n	74,40

Leichte Farbunterschiede zwischen Stange, Endknöpfen und Wandträger können aus produktionstechnischen Gründen auftreten.

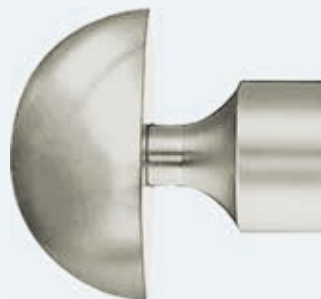

Imperia

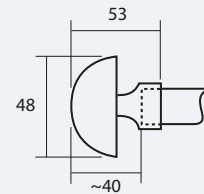

Katja

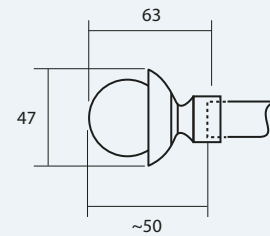

Alassio

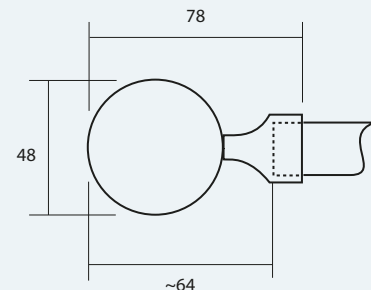

Messing
Ø20

Endknöpfe Messing Ø20 mm

Imperia



poliert lackiert



verchromt



messing matt



nickel matt
Maßstab 1:1

Endknopf Imperia

		Stück
poliert lackiert	834 920 p	74,40
verchromt	834 920 v	74,40
messing matt	834 920 m	74,40
nickel matt	834 920 n	74,40

Katja

andere Farbbeispiele:



verchromt



poliert lackiert/
nickel matt



poliert lackiert/
verchromt



poliert lackiert
Maßstab 1:1

Endknopf Katja

		Stück
poliert lackiert	833 520 p	84,70
verchromt	833 520 v	116,-
messing matt	833 520 m	90,70
nickel matt	833 520 n	113,50
Adapter poliert lackiert/ Kugel nickel matt	833 520 pn	122,-
Adapter poliert lackiert/ Kugel verchromt	833 520 pv	122,-

Alassio



messing matt
Maßstab 1:1



poliert lackiert



verchromt



nickel matt

Endknopf Alassio

		Stück
poliert lackiert	832 320 p	96,-
verchromt	832 320 v	96,-
messing matt	832 320 m	96,-
nickel matt	832 320 n	96,-

Leichte Farbunterschiede zwischen Stange, Endknöpfen und Wandträger können aus produktionstechnischen Gründen auftreten.



Cremona

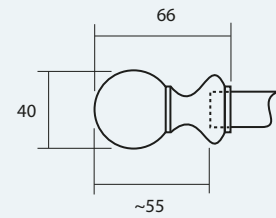

Lisa

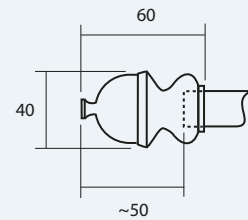

Sabine

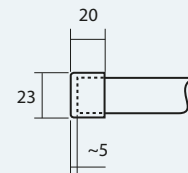

Messing
Ø20

Endknöpfe Messing Ø20 mm

Cremona



poliert lackiert
Maßstab 1:1

Endknopf Cremona		Stück
poliert lackiert	 830 120 p	33,60

Lisa



poliert lackiert
Maßstab 1:1

Endknopf Lisa		Stück
poliert lackiert	 830 320 p	33,60

Sabine



verchromt







nickel matt



messaging matt



poliert lackiert
Maßstab 1:1

Endknopf Sabine		Stück
poliert lackiert	 830 020 p	19,20
verchromt	 830 020 v	19,20
messaging matt	 830 020 m	19,20
nickel matt	 830 020 n	19,20

Leichte Farbunterschiede zwischen Stange, Endknöpfen und Wandträger können aus produktionstechnischen Gründen auftreten.

flIX

Ø20

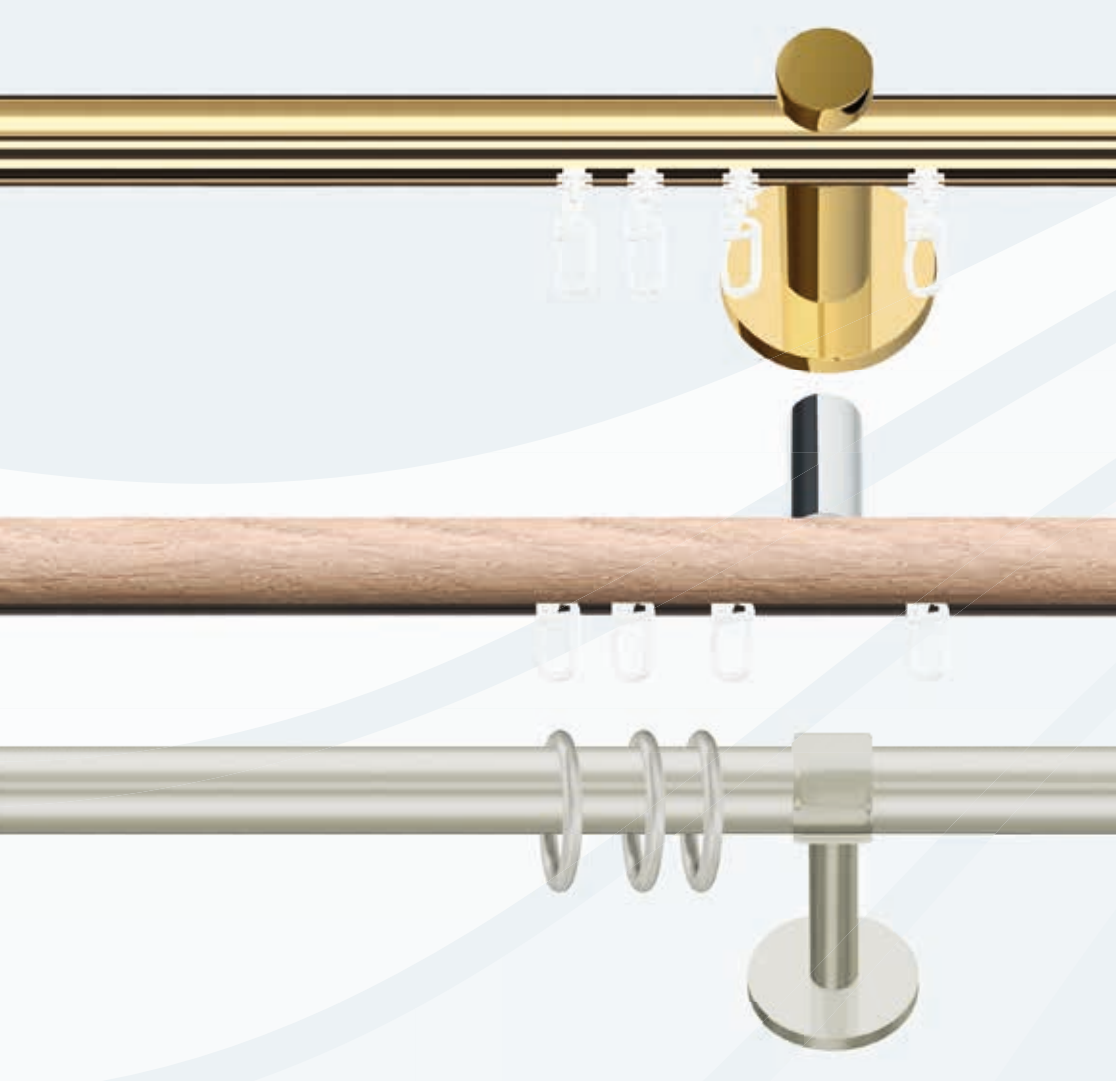

Messing
Ø20

Träger-
systeme

Messing Ø20mm Trägersysteme

Messing Ø20mm - Trägersysteme



Innenlauf-Wandträger
Seite 103

Farben Zubehör: 

Farben Stangen: 



Innenlauf-Deckenträger
Seite 107

Farben Zubehör: 

Farben Stangen: 

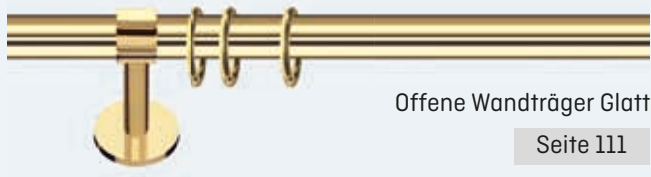

Offene Wandträger Glatt
Seite 111

Farben Zubehör & Stangen: 



Offene Wandträger Rund
Seite 115

Farben Zubehör & Stangen: 



Offene Wandträger Glatt
Storeschiene mit Alu Innenlauf Profil
Seite 119

Farben Zubehör & Stangen: 



Offene Wandträger Rund
Storeschiene mit Alu Innenlauf Profil
Seite 115

Farben Zubehör & Stangen: 



Geschlossene Wandträger Rund
Seite 123

Farben Zubehör & Stangen: 



mit KLIXI
Drehgleiter

Erkerausführung



verchromt

Farben Zubehör



poliert lackiert



verchromt



messing matt



nickel matt

Farben Innenlauf-Profile



poliert lackiert



verchromt



messing matt



nickel matt



buche*



wildeiche*



zwetschke*



schwarz matt

* IL-Profile in buche, wildeiche, zwetschke: Laufroller Art. 2420

Innenlauf-Wandträger

Garnituren mit Innenlauf-Wandträgern ohne Endknöpfe

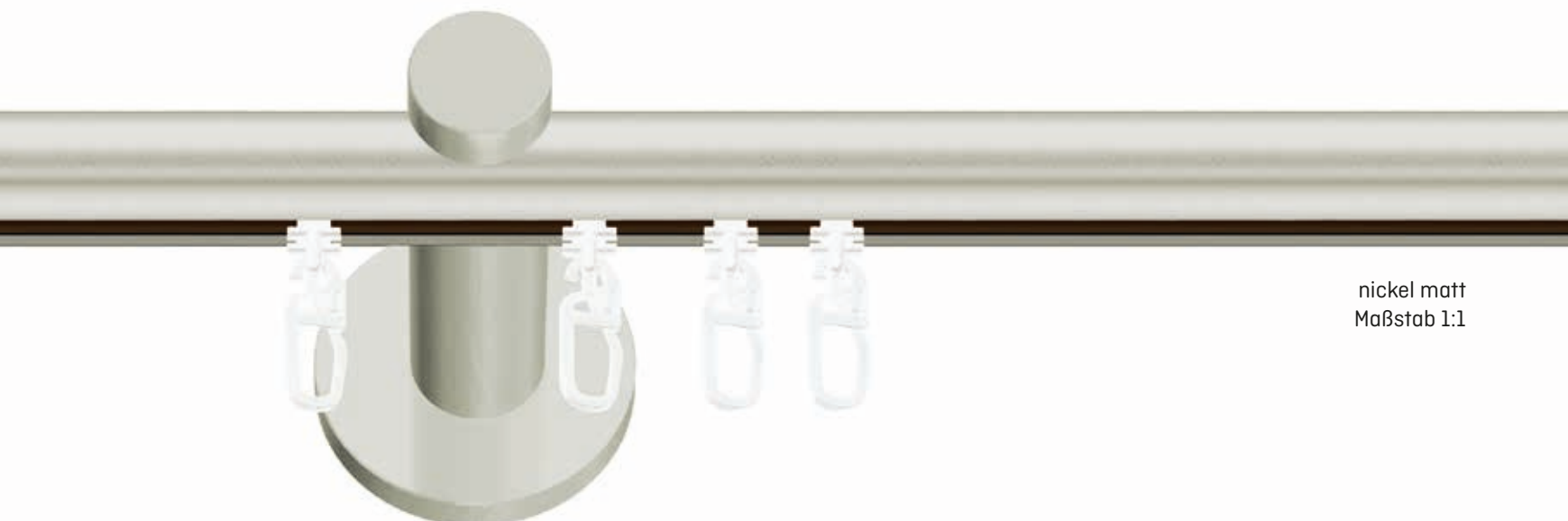

nickel matt
Maßstab 1:1

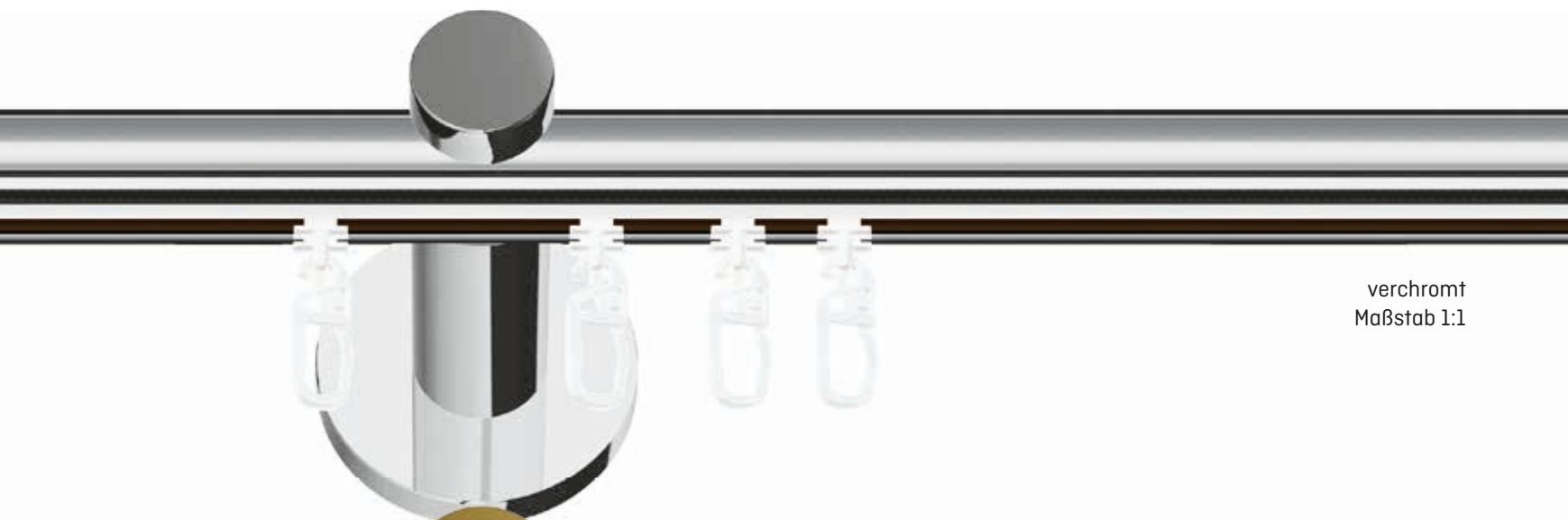

verchromt
Maßstab 1:1

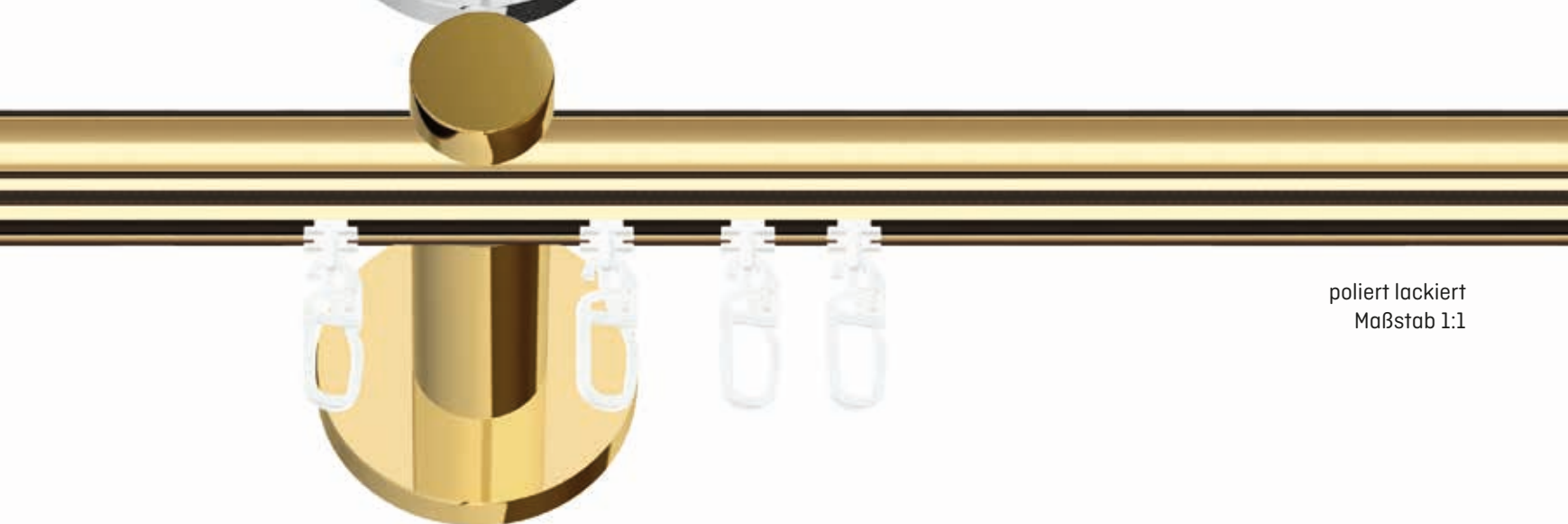

poliert lackiert
Maßstab 1:1

Lieferumfang

- ▶ **1 lfg:** 1 Alu Innenlauf-Profil Ø20mm oberflächenbehandelt, je nach Länge Wandträger und -Drehgleiter lt. Liste
- ▶ **2 lfg:** 2 Alu Innenlauf-Profile Ø20mm oberflächenbehandelt, je nach Länge Wandträger und -Drehgleiter lt. Liste, 2 Endkappen

- ▶ mit Montagematerial
- ▶ Bestellmaß = Profilmaß
- ▶ Trägermitte bis Innenlauf-Profilunterkante: 20mm
- ▶ bei geänderter Ausführung Aufpreis bzw. Preisänderung
- ▶ **Aus produktionstechnischen Gründen bestehen geringfügige Farbabweichungen zwischen den Karniesenkomponenten.**
- ▶ **IL-Profile in buche, wildeiche, zwetschke: nur Laufroller Art. 2420 ohne Aufpreis**

Trägermaße

Träger 1-läufig:

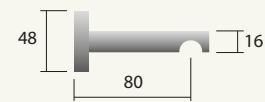

Träger 2-läufig:

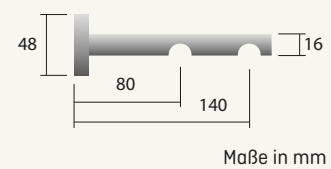

Maße in mm

											Preisänderung für IL-Profil in:	
Bestellcode:			t20-070	t20-071	t20-048	t20-049	t20-040	t20-041	t20-044	t20-045	buche wildeiche zwetschke schwarz matt	
Länge (cm)	Wand-träger	Gleiter 1l./2l.	1lfg	2lfg	1lfg	2lfg	1lfg	2lfg	1lfg	2lfg	1lfg	2lfg
100	2	16/32	173	303	193	303	180	303	182	304	-22	-44
120	2	18/36	184	325	204	325	191	325	194	328	-26	-52
140	2	22/44	195	347	215	347	202	347	206	352	-30	-60
160	2	26/52	206	369	226	369	213	369	218	376	-34	-68
180	2	28/54	217	391	237	391	224	391	230	400	-38	-76
200	2	32/64	228	413	248	413	235	413	242	424	-42	-84
220	3	34/68	296	513	328	513	309	513	315	523	-46	-92
240	3	38/76	307	535	339	535	320	535	327	547	-50	-100
260	3	42/84	318	557	350	557	331	557	339	571	-54	-108
280	3	44/88	329	579	361	579	342	579	351	595	-58	-116
300	3	48/96	340	601	372	601	353	601	363	619	-62	-124
320	3	50/100	351	623	383	623	364	623	375	643	-66	-132
340	3	54/108	362	645	394	645	375	645	387	667	-70	-140
360	3	58/116	373	667	405	667	386	667	399	691	-74	-148
380	3	60/120	384	689	416	689	397	689	411	715	-78	-156
400	4	64/128	452	790	497	790	472	790	483	813	-82	-164
+ 20 cm ▲		3/6	11	22	11	22	11	22	12	24	-4	-8
Preisänderung bei Wandlager	1-seitig		-23	-19,20	-26,40	-11,50	-20,10	-11,50	-23,60	-17,10		
	2-seitig		-45,90	-38,40	-52,70	-23	-40,30	-23	-47,10	-34,30		

▲ ab einer Länge von ca. 580 cm bzw. bei schwereren Vorhängen wird ein weiterer Träger empfohlen (Aufpreis)

Träger kürzen: 19,-/Stück



Träger 1-läufig:

kürzbar um max. 38 mm

Träger 2-läufig:

kürzbar um max. 38 mm

Messing
Ø20
Träger-systeme

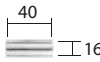
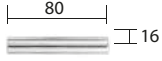
Träger und passende Verlängerungen				
Wandträger 1lfg - Wandabstand 50mm				
		poliert lackiert	871 049 p	58,80
		verchromt	871 049 v	58,80
		nickel matt	871 049 n	58,80
		messing matt	871 049 m	58,80
Wandträger 1lfg - Wandabstand 80mm				
		poliert lackiert	871 052 p	62,40
		verchromt	871 052 v	62,40
		nickel matt	871 052 n	62,40
		messing matt	871 052 m	62,40
				Stück
Wandträger 2lfg - Wandabstand 80/140mm				
		poliert lackiert	871 142 p	76,80
		verchromt	871 142 v	76,80
		nickel matt	871 142 n	76,80
		messing matt	871 142 m	76,80
				Stück
Trägerverlängerung für Wand-/Deckenträger, 40mm				
		poliert lackiert	871 044 p	21,60
		verchromt	871 044 v	21,60
		nickel matt	871 044 n	21,60
		messing matt	871 044 m	21,60
				Stück
Trägerverlängerung für Wand-/Deckenträger, 80mm				
		poliert lackiert	871 066 p	24,-
		verchromt	871 066 v	24,-
		nickel matt	871 066 n	24,-
		messing matt	871 066 m	24,-
				Stück

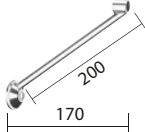
Trägerstütze				
		poliert lackiert	810 7291 p	55,20
		verchromt	810 7291 v	55,20
		nickel matt	810 7291 n	55,20
		messing matt	810 7291 m	55,20
				Stück

Wandlager Ø20mm				
		poliert lackiert	82 320 p	38,40
		verchromt	82 320 v	38,40
		nickel matt	82 320 n	38,40
		messing matt	82 320 m	38,40
				Stück

Endkappe Ø20mm				
		poliert lackiert	830 020 p	19,20
		verchromt	830 020 v	19,20
		nickel matt	830 020 n	19,20
		messing matt	830 020 m	19,20
				Stück

Endkappe flächenbündig Anna Ø20mm				
		poliert lackiert	831 420 p	28,80
		verchromt	831 420 v	28,80
		nickel matt	831 420 n	28,80
		messing matt	831 420 m	28,80
				Stück

Alu Innenlauf-Profil Ø20mm, Stange 6m				Meter
	poliert lackiert	n90 620 p	63,50	
	verchromt	n90 620 v	63,50	
	nickel matt	n90 620 n	63,50	
	messing matt	n90 620 m	63,50	
	buche	n90 620 bu	41,40	
	wildeiche	n90 620 wi	41,40	
	zwetschke	n90 620 zw	41,40	
	schwarz matt	n90 620 sm	38,60	

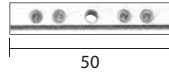
Profilverbinder Messing				Stück
	vernickelt	904 071	12,-	

Profilverbinder Messing, beliebiger Winkel				Stück
	vernickelt	904 072 - bw	28,80	

Gehungsschnitt (ohne Profilverbinder)				Gehrung
	90°	1bg-1gs-90	20,-	
	beliebiger Winkel	1bg-1gs-bw	49,-	

KLIXI-Drehgleiter 100 Stück				Beutel
	Kunststoff grau	2400 100 g	12,-	
	Kunststoff weiß	2400 100 w	12,-	

Gleiter 100 Stück				Beutel
	Kunststoff weiß	3942 100	5,40	

Ösengleiter 100 Stück				Beutel
	Kunststoff weiß	3910 100	9,90	

Gardinen-Einfachhaken 100 Stück				Beutel
	Kunststoff weiß	601 100	6,50	

Gardinen-Doppelhaken 100 Stück				Beutel
	Kunststoff weiß	605 100	11,-	

Roller mit Faltenleghaken				Stück
	Kunststoff weiß	2420	0,20	

 Biegunen siehe Gruppe 10

KLIXI® mit KLIXI Drehgleiter

Erkerausführung



Farben Zubehör



poliert lackiert



verchromt



messing matt



nickel matt

Farben Innenlauf-Profile



poliert lackiert



verchromt



messing matt



nickel matt



buche*



wildeiche*



zwetschke*



schwarz matt

* IL-Profile in buche, wildeiche, zwetschke: Laufroller Art. 2420

Messing
Ø20

Träger-
systeme

Innenlauf-Deckenträger

Garnituren mit Innenlauf-Deckenträgern ohne Endknöpfe



nickel matt
mit Deckenträger 871 076
Deckenabstand 15mm
Maßstab 1:1





verchromt
mit Deckenträger 871 077
Profil wildeiche
Deckenabstand 35mm
Maßstab 1:1



poliert lackiert
mit Deckenträger 871 053
Deckenabstand 43mm
Maßstab 1:1

Lieferumfang

- ▶ **1 lfg mit Deckenträger 15mm Deckenabstand:**
1 Alu Innenlauf-Profil Ø20mm oberflächenbehandelt, je nach Länge Deckenträger und -Drehgleiter lt. Liste
 - ▶ **1 lfg mit Deckenträger 35mm Deckenabstand:**
1 Alu Innenlauf-Profil Ø20mm oberflächenbehandelt, je nach Länge Deckenträger und -Drehgleiter lt. Liste
 - ▶ **1 lfg mit Deckenträger 43mm Deckenabstand:**
1 Alu Innenlauf-Profil Ø20mm oberflächenbehandelt, je nach Länge Deckenträger und -Drehgleiter lt. Liste
- ▶ mit Montagematerial
 - ▶ Bestellmaß = Profilmaß
 - ▶ Decke bis Innenlauf-Profilunterkante: siehe Maßskizzen rechts
 - ▶ bei geänderter Ausführung Aufpreis bzw. Preisabschlag
 - ▶ **Aus produktionstechnischen Gründen bestehen geringfügige Farbabweichungen zwischen den Karniesenkomponenten.**
 - ▶ **IL-Profile in buche, wildeiche, zwetschke: nur Laufroller Art. 2420 ohne Aufpreis**

Trägermaße

Träger 1-läufig Art. 871 076
Deckenabstand 15mm:

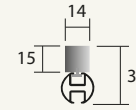

Träger 1-läufig Art. 871 077
Deckenabstand 35mm:

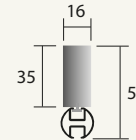

Träger 1-läufig Art. 871 053
Deckenabstand 43mm:

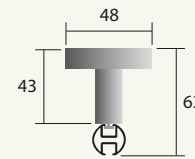

Maße in mm

Bestellcode:	poliert lackiert		verchromt		nickel matt		messaging matt		Preisänderung für IL-Profil in:						
	t20-311	t20-312	t20-313	t20-314	t20-315	t20-316	t20-317	t20-318	t20-319	t20-320	t20-321	t20-322	buche	wildeiche	zwetschke
Länge (cm)	Decken-träger	Gleiter	1lfg	1lfg	1lfg	1lfg	1lfg	1lfg	1lfg	1lfg	1lfg	1lfg	1lfg	1lfg	1lfg
100	2	16	111	124	166	111	124	166	111	124	166	112	124	166	-22
120	2	18	122	135	177	122	135	177	122	135	177	124	136	178	-26
140	2	22	133	146	188	133	146	188	133	146	188	136	148	190	-30
160	2	26	144	157	199	144	157	199	144	157	199	148	160	202	-34
180	2	28	155	168	210	155	168	210	155	168	210	160	172	214	-38
200	2	32	166	179	221	166	179	221	166	179	221	172	184	226	-42
220	3	34	205	225	289	205	225	289	205	225	289	210	228	293	-46
240	3	38	216	236	300	216	236	300	216	236	300	222	240	305	-50
260	3	42	227	247	311	227	247	311	227	247	311	234	252	317	-54
280	3	44	238	258	322	238	258	322	238	258	322	246	264	329	-58
300	3	48	249	269	333	249	269	333	249	269	333	258	276	341	-62
320	3	50	260	280	344	260	280	344	260	280	344	270	288	353	-66
340	3	54	271	291	355	271	291	355	271	291	355	282	300	365	-70
360	3	58	282	302	366	282	302	366	282	302	366	294	312	377	-74
380	3	60	293	313	377	293	313	377	293	313	377	306	324	389	-78
400	4	64	333	360	444	333	360	444	333	360	444	345	369	457	-82
+20 cm	▲	3	11	11	11	11	11	11	11	11	11	12	12	12	-4

▲ ab einer Länge von ca. 580 cm bzw. bei schwereren Vorhängen wird ein weiterer Träger empfohlen (Aufpreis)

Messing
Ø20
Träger-
systeme

Träger und passende Verlängerungen

Deckenträger, Deckenabstand 35mm Stück

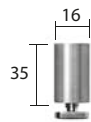

poliert lackiert	871 077 p	31,20
verchromt	871 077 v	31,20
nickel matt	871 077 n	31,20
messing matt	871 077 m	31,20

Deckenträger 1lfg., Deckenabstand 43mm/Ø16mm Stück



poliert lackiert	871 053 p	50,40
verchromt	871 053 v	50,40
nickel matt	871 053 n	50,40
messing matt	871 053 m	50,40

Deckenträger 2lfg., Deckenabstand 53mm/Ø16mm Stück

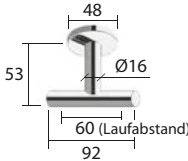

poliert lackiert	871 153 p	81,60
verchromt	871 153 v	81,60
nickel matt	871 153 n	81,60
messing matt	871 153 m	81,60

Trägerverlängerung für Wand-/Deckenträger, 40mm Stück

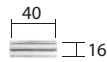

poliert lackiert	871 044 p	21,60
verchromt	871 044 v	21,60
nickel matt	871 044 n	21,60
messing matt	871 044 m	21,60

Trägerverlängerung für Wand-/Deckenträger, 80mm Stück

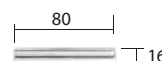

poliert lackiert	871 066 p	24,-
verchromt	871 066 v	24,-
nickel matt	871 066 n	24,-
messing matt	871 066 m	24,-

Deckenträger, Deckenabstand 15mm Stück



poliert lackiert	871 076 p	25,20
verchromt	871 076 v	25,20
nickel matt	871 076 n	25,20
messing matt	871 076 m	25,20

Endkappe Ø20mm Stück



poliert lackiert	830 020 p	19,20
verchromt	830 020 v	19,20
nickel matt	830 020 n	19,20
messing matt	830 020 m	19,20

Endkappe flächenbündig Anna Ø20mm Stück



poliert lackiert	831 420 p	28,80
verchromt	831 420 v	28,80
nickel matt	831 420 n	28,80
messing matt	831 420 m	28,80

Wandlager Ø20mm Stück

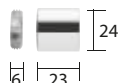

poliert lackiert	82 320 p	38,40
verchromt	82 320 v	38,40
nickel matt	82 320 n	38,40
messing matt	82 320 m	38,40

Alu Innenlauf-Profilrohr Ø20mm, Stange 6m Meter



poliert lackiert	n90 620 p	63,50
verchromt	n90 620 v	63,50
nickel matt	n90 620 n	63,50
messing matt	n90 620 m	63,50
buche	n90 620 bu	41,40
wildeiche	n90 620 wi	41,40
zwetschke	n90 620 zw	41,40
schwarz matt	n90 620 sm	38,60

Profilverbinder Messing Stück

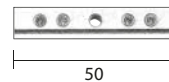

vernickelt	904 071	12,-
------------	---------	------

Profilverbinder Messing, beliebiger Winkel Stück

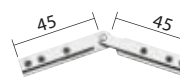

vernickelt	904 072 - bw	28,80
------------	--------------	-------

Gehungsschnitt (ohne Profilverbinder) Gehrung



90°	1bg-1gs-90	20,-
beliebiger Winkel	1bg-1gs-bw	49,-

KLIXI-Drehgleiter 100 Stück Beutel



Kunststoff grau	2400 100 g	12,-
Kunststoff weiß	2400 100 w	12,-

Gleiter 100 Stück Beutel



Kunststoff	3942 100	5,40
------------	----------	------

Ösengleiter 100 Stück Beutel



Kunststoff weiß	3910 100	9,90
-----------------	----------	------

Gardinen-Einfachhaken 100 Stück Beutel



Kunststoff weiß	601 100	6,50
-----------------	---------	------

Gardinen-Doppelhaken 100 Stück Beutel



Kunststoff weiß	605 100	11,-
-----------------	---------	------

Roller mit Faltenleghaken Stück



Kunststoff weiß	2420	0,20
-----------------	------	------

Biegungen siehe Gruppe 10



mit Rohren aus
Reinmessing

Erkerausführung



Biegung



Gehrung



Gelenk

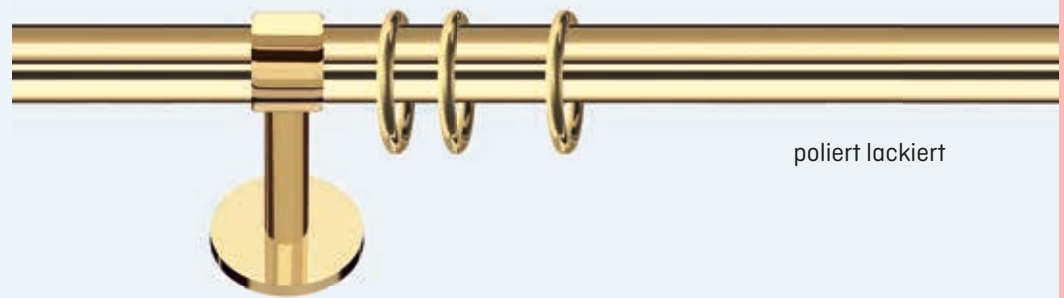

poliert lackiert

Messing
Ø20

Träger-
systeme

Farben Zubehör & Stangen



poliert lackiert



verchromt



messing matt



nickel matt

Offene Wandträger Glatt

Garnituren mit Offenen Wandträgern Glatt ohne Endknöpfe

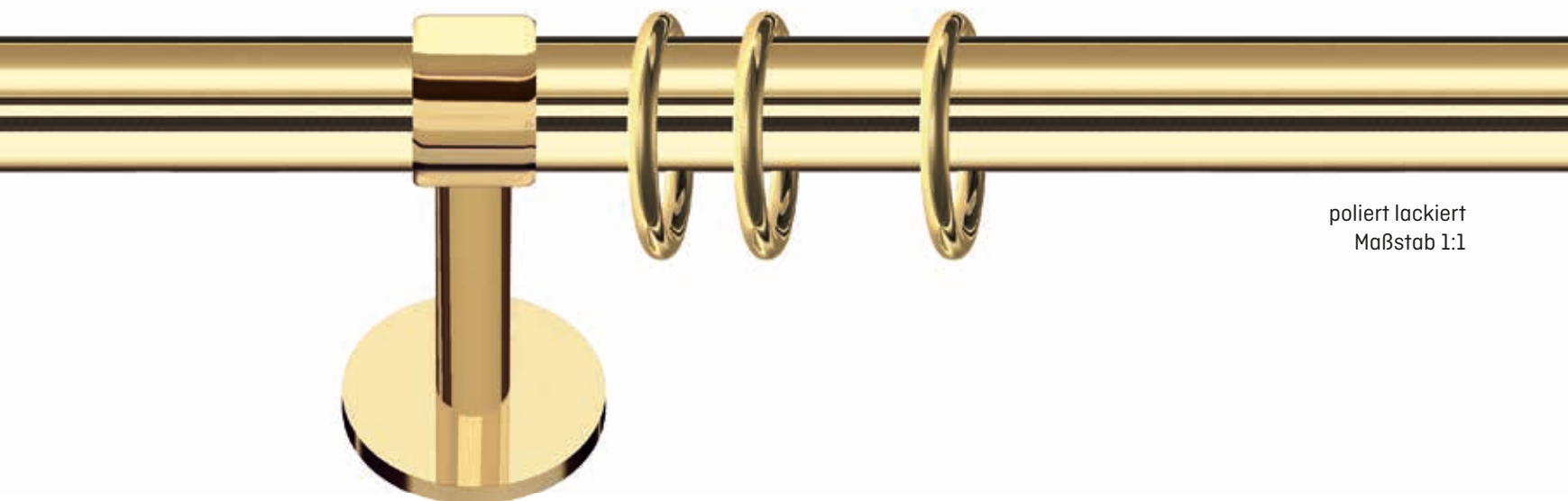

poliert lackiert
Maßstab 1:1

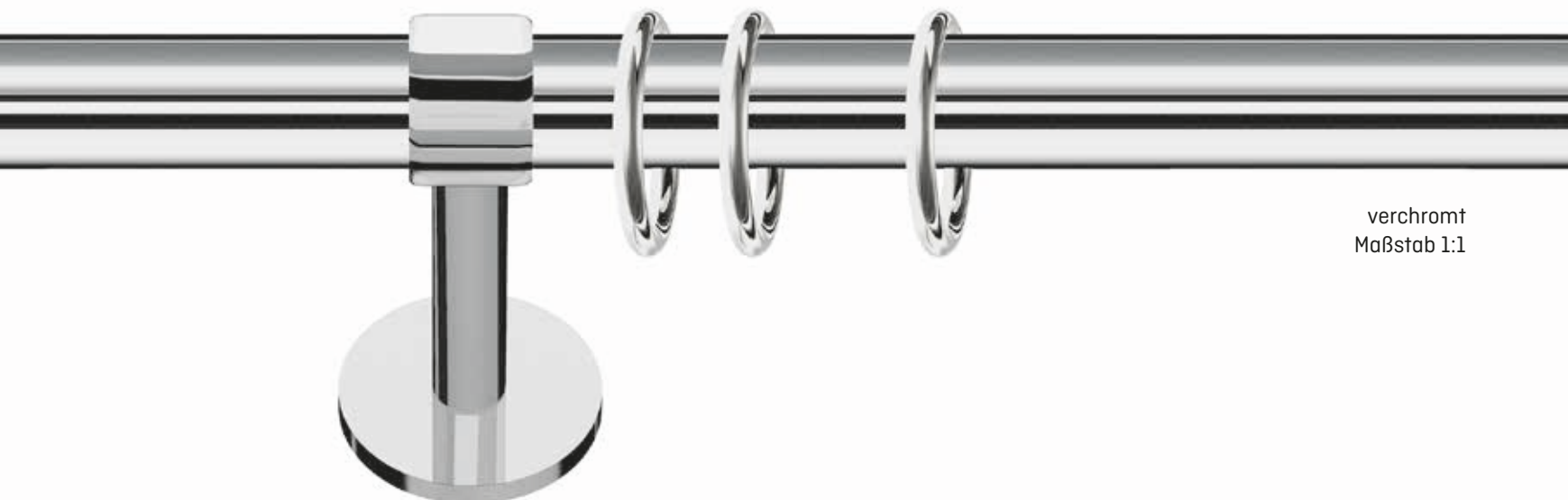

verchromt
Maßstab 1:1

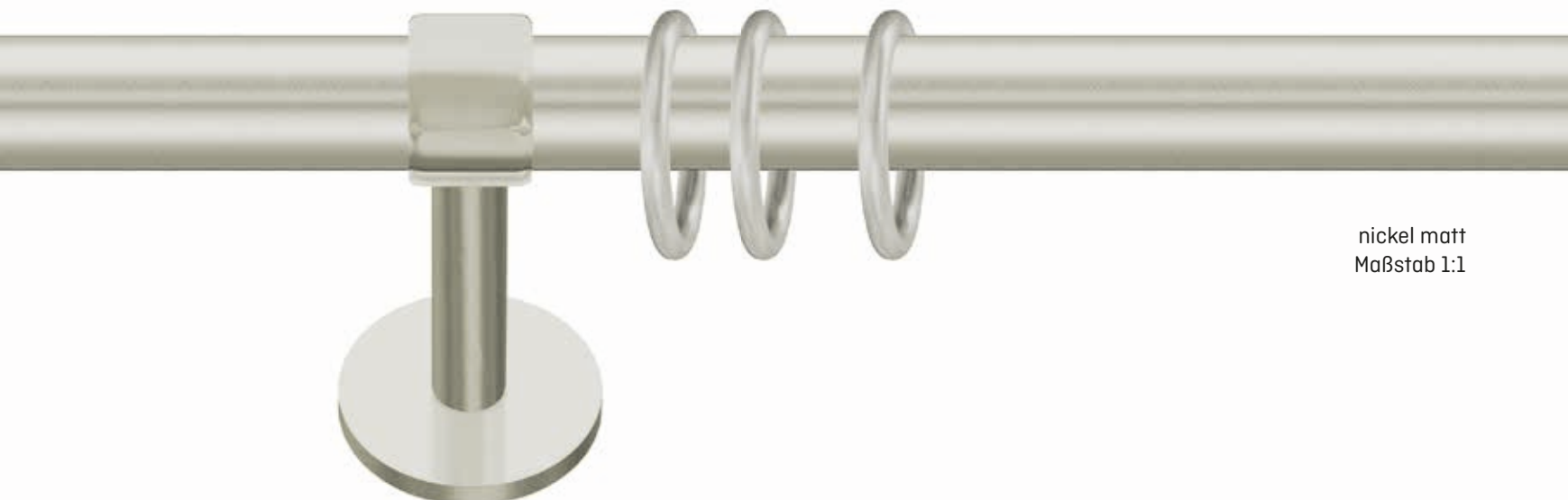

nickel matt
Maßstab 1:1

Lieferumfang

- ▶ **1 lfg:** 1 Reinmessing-Rohr Ø20mm oberflächenbehandelt, je nach Länge Wandträger und Ringe mit Faltenleghaken lt. Liste
- ▶ **2 lfg:** 2 Reinmessing-Rohre Ø20mm oberflächenbehandelt, je nach Länge Wandträger und Ringe mit Faltenleghaken lt. Liste, 2 Endkappen

- ▶ mit Montagematerial
- ▶ Bestellmaß = Rohrmaß
- ▶ Trägermitte bis Ringunterkante: 22mm
- ▶ bei geänderter Ausführung Aufpreis bzw. Preisänderung
- ▶ **Aus produktionstechnischen Gründen bestehen geringfügige Farbabweichungen zwischen den Karniesenkomponenten.**

Trägermaße

Träger 1-läufig:

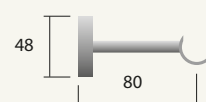

Träger 2-läufig:

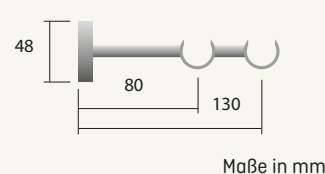

Maße in mm

Bestellcode:			t20-016	t20-017	t20-018	t20-019	t20-010	t20-011	t20-014	t20-015
Länge (cm)	Wand-träger	Ringe 1l./2l.	1lfg 	2lfg 	1lfg 	2lfg 	1lfg 	2lfg 	1lfg 	2lfg
100	2	14/28	224	444	234	464	220	436	209	416
120	2	16/32	237	471	249	495	235	467	222	443
140	2	20/40	250	498	264	526	250	498	235	470
160	2	22/44	263	525	279	557	265	529	248	497
180	2	24/48	276	552	294	588	280	560	261	524
200	2	28/56	289	579	309	619	295	591	274	551
220	3	30/60	381	738	403	781	381	740	359	695
240	3	34/68	394	765	418	812	396	771	372	722
260	3	36/72	407	792	433	843	411	802	385	749
280	3	38/76	420	819	448	874	426	833	398	776
300	3	42/84	433	846	463	905	441	864	411	803
320	3	44/88	446	873	478	936	456	895	424	830
340	3	48/96	459	900	493	967	471	926	437	857
360	3	50/100	472	927	508	998	486	957	450	884
380	3	52/104	485	954	523	1.029	501	988	463	911
400	4	56/112	583	1.121	622	1.200	593	1.145	552	1.064
+ 20cm	▲	3/6	13	27	15	31	15	31	13	27
Preisänderung bei Wandlager	1-seitig		-44,50	-86,60	-41,10	-79,80	-33,60	-65,50	-33,60	-65,50
	2-seitig		-89,10	-173,30	-82,20	-159,50	-67,10	-131	-67,10	-131

▲ ab einer Länge von ca. 580 cm bzw. bei schwereren Vorhängen wird ein weiterer Träger empfohlen (Aufpreis)

Träger kürzen: 19,-/Stück

Träger 1-läufig:

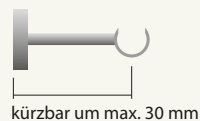

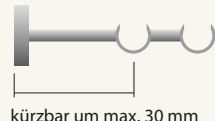

Träger 2-läufig:

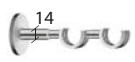
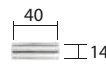
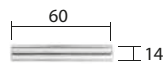

Messing
Ø20
Träger-systeme

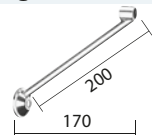
Träger und passende Verlängerungen				
Wandträger 1lfg - Wandabstand 80mm				
			Stück	
	poliert lackiert	810 720 p	78,-	
	verchromt	810 720 v	78,-	
	nickel matt	810 720 n	71,-	
	messing matt	810 720 m	71,-	
Wandträger 2lfg - Wandabstand 80/130mm				
			Stück	
	poliert lackiert	810 820 p	138,-	
	verchromt	810 820 v	138,-	
	nickel matt	810 820 n	123,80	
	messing matt	810 820 m	123,80	
Trägerverlängerung 40mm				
			Stück	
	poliert lackiert	810 014 - 40 p	19,20	
	verchromt	810 014 - 40 v	19,20	
	nickel matt	810 014 - 40 n	19,20	
	messing matt	810 014 - 40 m	19,20	
Trägerverlängerung 60mm				
			Stück	
	poliert lackiert	810 014 - 60 p	24,-	
	verchromt	810 014 - 60 v	24,-	
	nickel matt	810 014 - 60 n	24,-	
	messing matt	810 014 - 60 m	24,-	

Trägerstütze				
			Stück	
	poliert lackiert	810 7291 p	55,20	
	verchromt	810 7291 v	55,20	
	nickel matt	810 7291 n	55,20	
	messing matt	810 7291 m	55,20	

Endkappe Ø20mm				
			Stück	
	poliert lackiert	830 020 p	19,20	
	verchromt	830 020 v	19,20	
	nickel matt	830 020 n	19,20	
	messing matt	830 020 m	19,20	

Endkappe flächenbündig Anna Ø20mm				
			Stück	
	poliert lackiert	831 420 p	28,80	
	verchromt	831 420 v	28,80	
	nickel matt	831 420 n	28,80	
	messing matt	831 420 m	28,80	

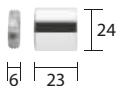
Wandlager Ø20mm				
			Stück	
	poliert lackiert	82 320 p	38,40	
	verchromt	82 320 v	38,40	
	nickel matt	82 320 n	38,40	
	messing matt	82 320 m	38,40	

Ring Ø20mm + FH				
			Stück	
	poliert lackiert	840 201 p	2,90	
	verchromt	840 201 v	2,90	
	nickel matt	840 201 n	2,90	
	messing matt	840 201 m	2,90	

Flachring Ø20mm mit Kunststoffeinlage + FH				
			Stück	
	poliert lackiert	848 201 p	3,60	
	verchromt	848 201 v	3,60	
	nickel matt	848 201 n	3,60	
	messing matt	848 201 m	3,60	

Messingrohr, Ø20mm, Stange 5m				Meter
	poliert lackiert	ms 2006 p	57,60	
	verchromt	ms 2006 v	57,60	
	nickel matt	ms 2006 n	57,60	
	messing matt	ms 2006 m	57,60	

Rohrverbinder, Ø20mm				Stück
	Metall/Kunststoff	1720		14,40

Gelenkverbinder Ø20mm				Stück
	poliert lackiert	8920 p	84,-	
	verchromt	8920 v	84,-	
	nickel matt	8920 n	84,-	
	messing matt	8920 m	84,-	

Faltenleghaken für Flachring				Stück
	Kunststoff glasklar	36003 gk		0,10

Faltenleghaken für Ring				Stück
	Kunststoff glasklar	36006 gk		0,10



mit Rohren aus
Reinmessing

Erkerausführung



Biegung



Gehrung



Gelenk



poliert lackiert



mit KLIXI
Drehgleiter

Erkerausführung



Biegung



Gehrung



Gelenk

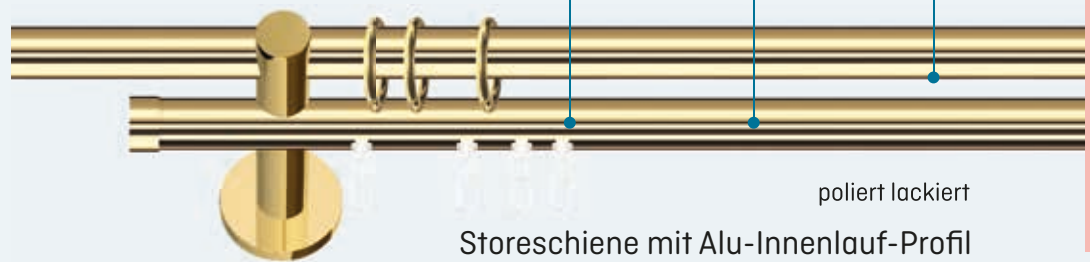

poliert lackiert

Storeschiene mit Alu-Innenlauf-Profil

Messing
Ø20

Träger-
systeme

Farben Zubehör & Stangen



poliert lackiert



verchromt



messing matt



nickel matt

Offene Wandträger Rund
Offene Wandträger Rund
Storeschiene mit Alu-Innenlauf-Profil

Garnituren mit Offenen Wandträgern Rund ohne Endknöpfe

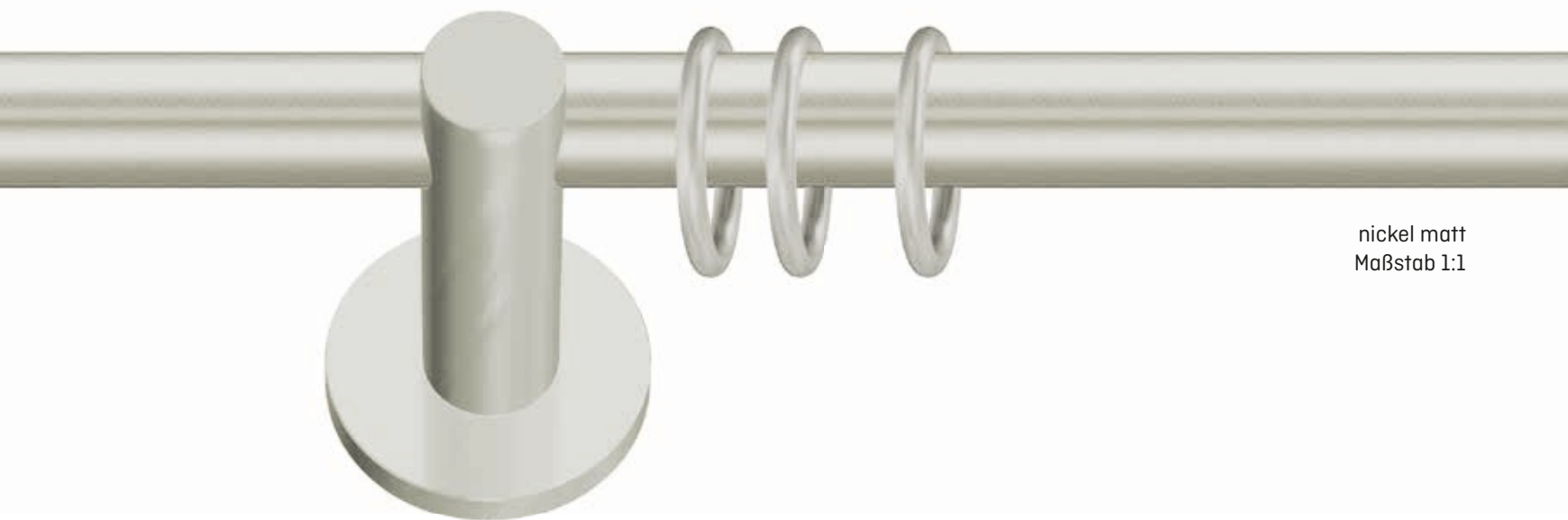

nickel matt
Maßstab 1:1



verchromt
Maßstab 1:1

Storeschiene mit Alu-Innenlauf-Profil

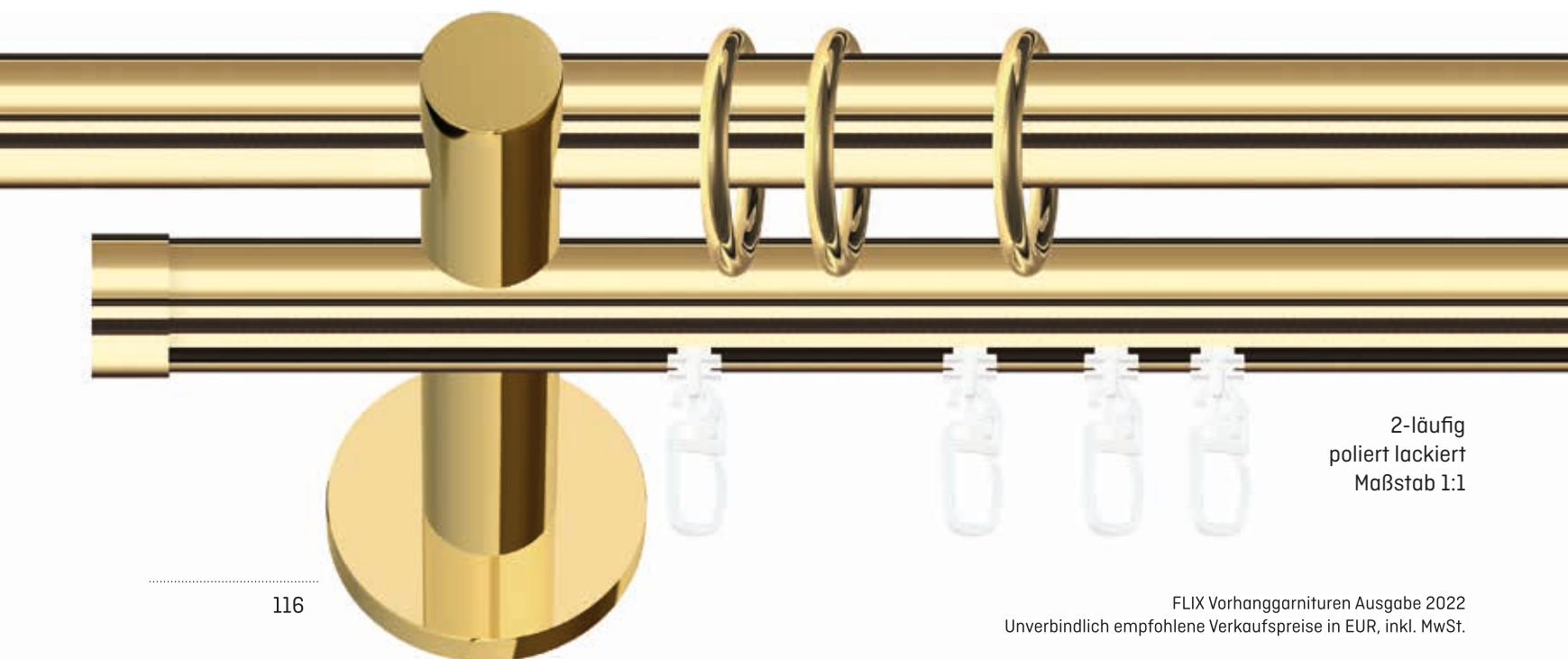

2-läufig
poliert lackiert
Maßstab 1:1

Lieferumfang

- ▶ **1 lfg:** 1 Reinmessing-Rohr Ø20mm oberflächenbehandelt, je nach Länge Wandträger und Ringe mit Faltenleghaken lt. Liste
- ▶ **2 lfg:** 2 Reinmessing-Rohre Ø20mm oberflächenbehandelt, je nach Länge Wandträger und Ringe mit Faltenleghaken lt. Liste, 2 Endkappen Art. 830 020
- ▶ **2 lfg mit Alu Innenlauf-Profil als 2. Lauf:** 1 Reinmessing-Rohr Ø20mm oberflächenbehandelt, 1 Alu Innenlauf-Profil Ø20mm oberflächenbehandelt, je nach Länge Wandträger, Ringe mit Faltenleghaken und  -Drehgleiter lt. Liste, 2 Endkappen

- ▶ mit Montagematerial
- ▶ Bestellmaß = Rohr-/Profilmaß
- ▶ Trägermitte bis Ringunterkante: 22mm
- ▶ Trägermitte bis Innenlaufprofil-Unterkante: 20mm
- ▶ bei geänderter Ausführung Aufpreis bzw. Preisänderung
- ▶ **Aus produktionstechnischen Gründen bestehen geringfügige Farbabweichungen zwischen den Karniesenkomponenten.**

Trägermaße

Träger 1-läufig:

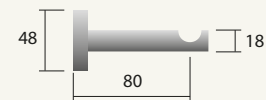



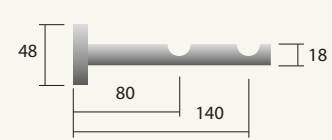

Träger 2-läufig:

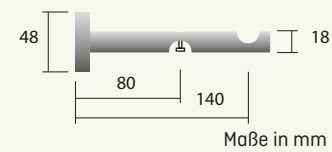

Träger 2-läufig:











Maße in mm





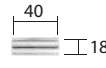
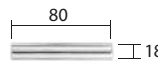
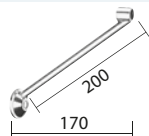

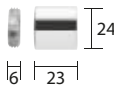
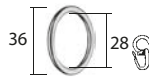



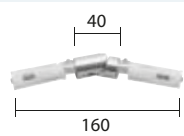

														
Bestellcode:			t20-026	t20-027	t20-030	t20-028	t20-029	t20-031	t20-020	t20-021	t20-032	t20-024	t20-025	t20-033
Länge (cm)	Wand-träger	Ringe 1l./2l.	1lfg	2lfg	2lfg	1lfg	2lfg	2lfg	1lfg	2lfg	2lfg	1lfg	2lfg	2lfg
100	2	14/28	212	357	338	223	379	349	223	379	349	212	357	349
120	2	16/32	227	387	364	240	413	377	240	413	377	227	387	377
140	2	20/40	242	417	390	257	447	405	257	447	405	242	417	405
160	2	22/44	257	447	416	274	481	433	274	481	433	257	447	433
180	2	24/48	272	477	442	291	515	461	291	515	461	272	477	461
200	2	28/56	287	507	468	308	549	489	308	549	489	287	507	489
220	3	30/60	368	616	576	392	664	600	393	666	601	368	616	600
240	3	34/68	383	646	602	409	698	628	410	700	629	383	646	628
260	3	36/72	398	676	628	426	732	656	427	734	657	398	676	656
280	3	38/76	413	706	654	443	766	684	444	768	685	413	706	684
300	3	42/84	428	736	680	460	800	712	461	802	713	428	736	712
320	3	44/88	443	766	706	477	834	740	478	836	741	443	766	740
340	3	48/96	458	796	732	494	868	768	495	870	769	458	796	768
360	3	50/100	473	826	758	511	902	796	512	904	797	473	826	796
380	3	52/104	488	856	784	528	936	824	529	938	825	488	856	824
400	4	56/112	574	974	898	617	1.062	942	619	1.065	943	574	974	942
+ 20cm	▲	3/6	15	30	26	17	34	28	17	34	28	15	30	28
Preisänderung bei Wandlager	1-seitig		-30,20	-26,80	-27	-26,40	-19,20	-19	-26,40	-19,20	-19	-26,40	-19,20	-19
	2-seitig		-60,40	-53,70	-54	-52,70	-38,40	-38	-52,70	-38,40	-38	-52,70	-38,40	-38

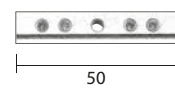
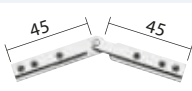
▲ ab einer Länge von ca. 580 cm bzw. bei schwereren Vorhängen wird ein weiterer Träger empfohlen (Aufpreis)

Träger kürzen: 19,-/Stück



Träger und passende Verlängerungen			
Wandträger 1lfg - Wandabstand 50mm Stück			
	poliert lackiert	815 119 p	58,80
	verchromt	815 119 v	58,80
	nickel matt	815 119 n	58,80
	messing matt	815 119 m	58,80
Wandträger 1lfg - Wandabstand 80mm Stück			
	poliert lackiert	815 120 p	62,40
	verchromt	815 120 v	62,40
	nickel matt	815 120 n	62,40
	messing matt	815 120 m	62,40
Wandträger 2lfg - Wandabstand 80/140mm Stück			
	poliert lackiert	815 520 p	76,80
	verchromt	815 520 v	76,80
	nickel matt	815 520 n	76,80
	messing matt	815 520 m	76,80
Wandträger 2. Rohr als IL-Rohr - WA 80/140mm Stück			
	poliert lackiert	871 054 p	76,80
	verchromt	871 054 v	76,80
	nickel matt	871 054 n	76,80
	messing matt	871 054 m	76,80
Trägerverlängerung 40mm Stück			
	poliert lackiert	871 043 p	21,60
	verchromt	871 043 v	21,60
	nickel matt	871 043 n	21,60
	messing matt	871 043 m	21,60
Trägerverlängerung 80mm Stück			
	poliert lackiert	871 065 p	26,40
	verchromt	871 065 v	26,40
	nickel matt	871 065 n	26,40
	messing matt	871 065 m	26,40
Trägerstütze Stück			
	poliert lackiert	810 7291 p	55,20
	verchromt	810 7291 v	55,20
	nickel matt	810 7291 n	55,20
	messing matt	810 7291 m	55,20
Endkappe Ø20mm Stück			
	poliert lackiert	830 020 p	19,20
	verchromt	830 020 v	19,20
	nickel matt	830 020 n	19,20
	messing matt	830 020 m	19,20
Wandlager Ø20mm Stück			
	poliert lackiert	82 320 p	38,40
	verchromt	82 320 v	38,40
	nickel matt	82 320 n	38,40
	messing matt	82 320 m	38,40
Ring Ø20mm + FH Stück			
	poliert lackiert	840 201 p	2,90
	verchromt	840 201 v	2,90
	nickel matt	840 201 n	2,90
	messing matt	840 201 m	2,90
Flachring Ø20mm mit Kunststoffeinfuge + FH Stück			
	poliert lackiert	848 201 p	3,60
	verchromt	848 201 v	3,60
	nickel matt	848 201 n	3,60
	messing matt	848 201 m	3,60
Messingrohr, Ø20mm, Stange 5m Meter			
	poliert lackiert	ms 2006 p	57,60
	verchromt	ms 2006 v	57,60
	nickel matt	ms 2006 n	57,60
	messing matt	ms 2006 m	57,60

Rohrverbinder Ø20mm			Stück
	Metall/Kunststoff	1720	14,40
Gelenkverbinder Ø20mm			Stück
	poliert lackiert	8920 p	84,-
	verchromt	8920 v	84,-
	nickel matt	8920 n	84,-
	messing matt	8920 m	84,-
Faltenleghaken für Flachring			Stück
	Kunststoff glasklar	36003 gk	0,10
Faltenleghaken für Ring			Stück
	Kunststoff glasklar	36006 gk	0,10
Alu Innenlauf-Profilrohr Ø20mm, Stange 6m			Meter
	poliert lackiert	n90 620 p	63,50
	verchromt	n90 620 v	63,50
	nickel matt	n90 620 n	63,50
	messing matt	n90 620 m	63,50
Profilverbinder Messing			Stück
	vernickelt	904 071	12,-
Profilverbinder Messing, beliebiger Winkel			Stück
	vernickelt	904 072 - bw	28,80
Gehungsschnitt (ohne Profilverbinder)			Gehung
	90°	1bg-1gs-90	20,-
	beliebiger Winkel	1bg-1gs-bw	49,-
KLIXI-Drehgleiter 100 Stück			Beutel
	Kunststoff grau	2400 100 g	12,-
	Kunststoff weiß	2400 100 w	12,-
Gleiter 100 Stück			Beutel
	Kunststoff	3942 100	5,40
Ösengleiter 100 Stück			Beutel
	Kunststoff weiß	3910 100	9,90
Gardinen-Einfachhaken 100 Stück			Beutel
	Kunststoff weiß	601 100	6,50
Gardinen-Doppelhaken 100 Stück			Beutel
	Kunststoff weiß	605 100	11,-
Roller mit Faltenleghaken			Stück
	Kunststoff weiß	2420	0,20



MESSING

Ø20



mit KLIXI
Drehgleiter



Dekorlauf mit Rohr
aus Reinmessing

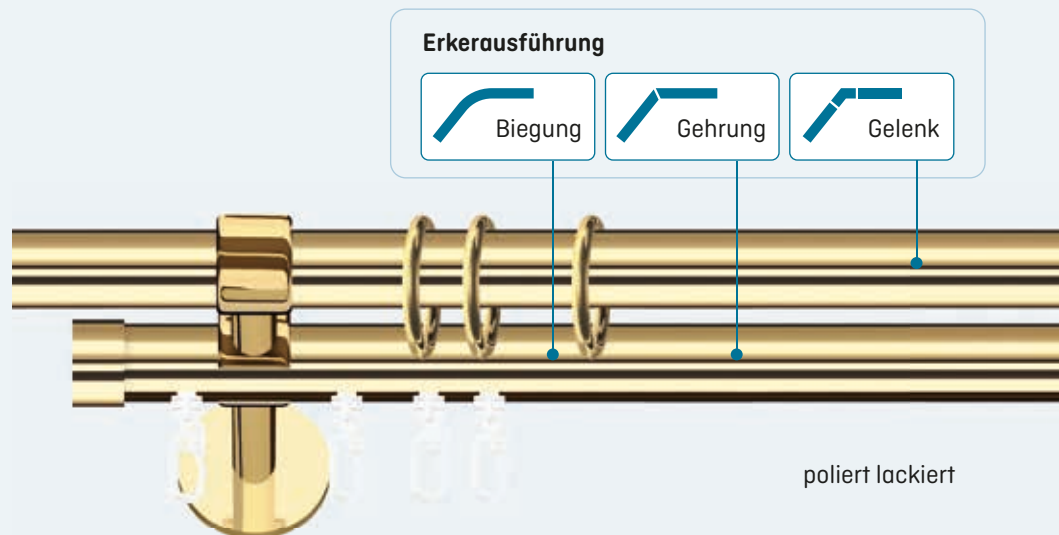

Messing
Ø20

Träger-
systeme

Farben Zubehör & Stangen



poliert lackiert



verchromt



messing matt



nickel matt

Offene Wandträger Glatt

Storeschiene mit Alu-Innenlauf-Profil

Garnituren: Storeschiene mit Alu-Innenlauf-Profil ohne Endknöpfe

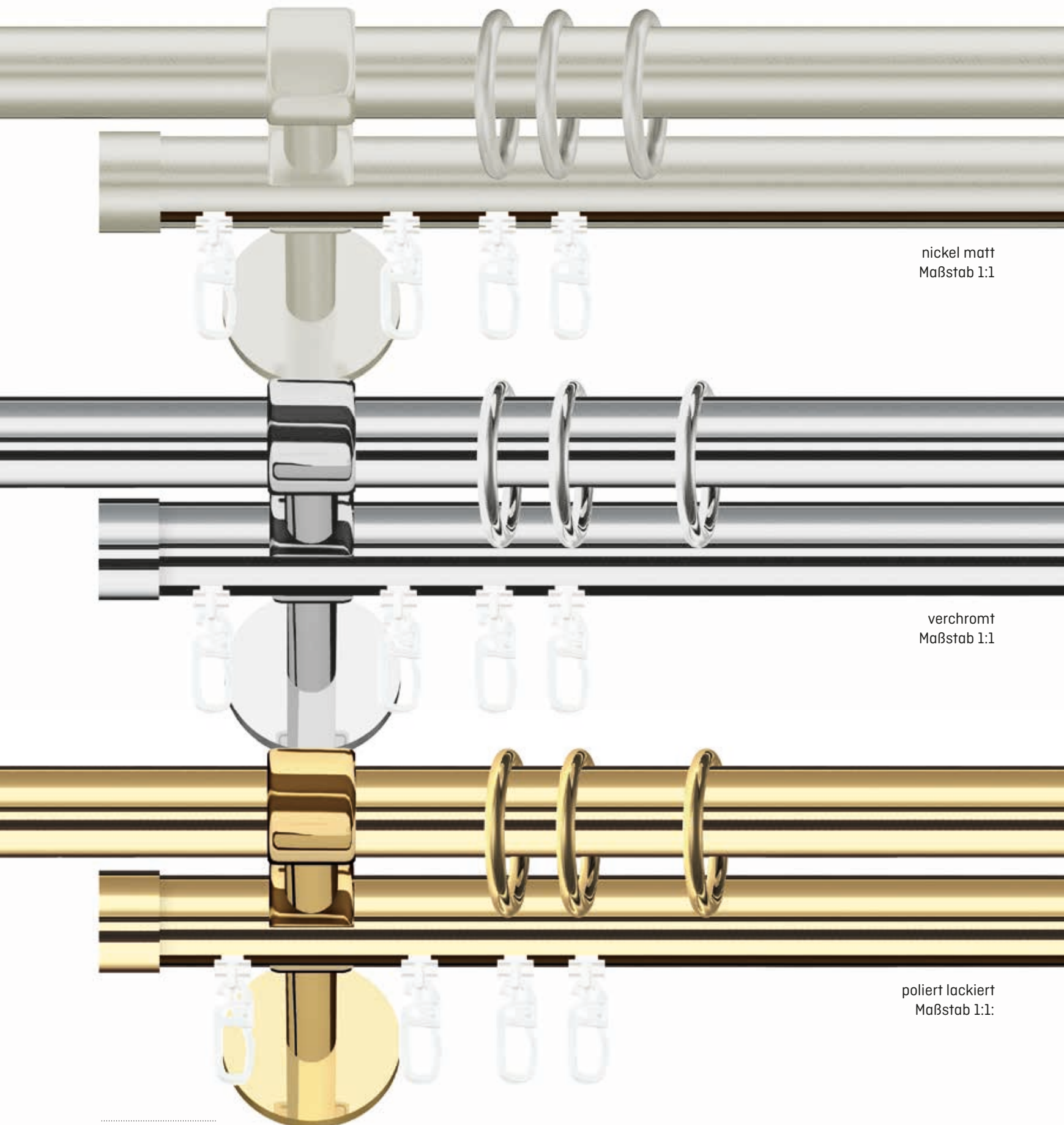

nickel matt
Maßstab 1:1

verchromt
Maßstab 1:1







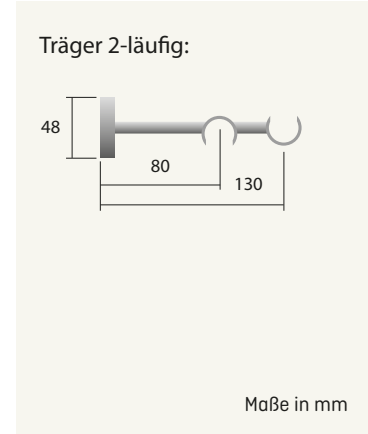

poliert lackiert
Maßstab 1:1

Lieferumfang

- ▶ 1 Reinmessing-Rohr Ø20mm oberflächenbehandelt, 1 Alu Innenlauf-Profil Ø20mm oberflächenbehandelt, je nach Länge Wandträger und Ringe mit Faltenleghaken und -Drehgleiter lt. Liste, 2 Endkappen
- ▶ mit Montagematerial
- ▶ Bestellmaß = Rohr-/Profilmaß
- ▶ Trägermitte bis Ringunterkante: 22mm
- ▶ Trägermitte bis Innenlaufprofil-Unterkante: 10mm
- ▶ bei geänderter Ausführung Aufpreis bzw. Preisänderung
- ▶ **Aus produktionstechnischen Gründen bestehen geringfügige Farbabweichungen zwischen den Karniesenkomponenten.**

Trägermaße



						
Bestellcode:			t20-053	t20-054	t20-050	t20-052
Länge (cm)	Wand-träger	Ringe/Gleiter	2lfg 	2lfg 	2lfg 	2lfg 
100	2	14/16	449	460	430	429
120	2	16/18	473	486	457	455
140	2	20/22	497	512	484	481
160	2	22/26	521	538	511	507
180	2	24/28	545	564	538	533
200	2	28/32	569	590	565	559
220	3	30/34	739	762	717	716
240	3	34/38	763	788	744	742
260	3	36/42	787	814	771	768
280	3	38/44	811	840	798	794
300	3	42/48	835	866	825	820
320	3	44/50	859	892	852	846
340	3	48/54	883	918	879	872
360	3	50/58	907	944	906	898
380	3	52/60	931	970	933	924
400	4	56/64	1.107	1.148	1.089	1.088
+ 20cm	▲	3/6	24	26	27	26
Preisänderung bei Wandlager	1-seitig		-91,90	-84,70	-69,50	-69,50
	2-seitig		-183,70	-169,40	-139	-139

▲ ab einer Länge von ca. 580 cm bzw. bei schwereren Vorhängen wird ein weiterer Träger empfohlen (Aufpreis)

Träger kürzen: 19,-/Stück

Träger 2-läufig:



kürzbar um max. 30mm

Messing
Ø20
Träger-systeme

Träger und passende Verlängerungen

Wandträger 2lfg - Wandabstand 80/130mm				Stück
	poliert lackiert	810 821 p	139,10	
	verchromt	810 821 v	139,10	
	nickel matt	810 821 n	124,60	
	messing matt	810 821 m	124,60	

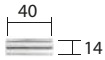
Trägerverlängerung 40mm				Stück
	poliert lackiert	810 014 - 40 p	19,20	
	verchromt	810 014 - 40 v	19,20	
	nickel matt	810 014 - 40 n	19,20	
	messing matt	810 014 - 40 m	19,20	

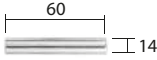
Trägerverlängerung 60mm				Stück
	poliert lackiert	810 014 - 60 p	24,-	
	verchromt	810 014 - 60 v	24,-	
	nickel matt	810 014 - 60 n	24,-	
	messing matt	810 014 - 60 m	24,-	

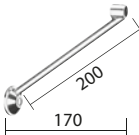
Trägerstütze				Stück
	poliert lackiert	810 7291 p	55,20	
	verchromt	810 7291 v	55,20	
	nickel matt	810 7291 n	55,20	
	messing matt	810 7291 m	55,20	

Endkappe Ø20mm				Stück
	poliert lackiert	830 020 p	19,20	
	verchromt	830 020 v	19,20	
	nickel matt	830 020 n	19,20	
	messing matt	830 020 m	19,20	

Endkappe flächenbündig Anna Ø20mm				Stück
	poliert lackiert	831 420 p	28,80	
	verchromt	831 420 v	28,80	
	nickel matt	831 420 n	28,80	
	messing matt	831 420 m	28,80	

Wandlager Ø20mm				Stück
	poliert lackiert	82 320 p	38,40	
	verchromt	82 320 v	38,40	
	nickel matt	82 320 n	38,40	
	messing matt	82 320 m	38,40	

Ring Ø20mm + FH				Stück
	poliert lackiert	840 201 p	2,90	
	verchromt	840 201 v	2,90	
	nickel matt	840 201 n	2,90	
	messing matt	840 201 m	2,90	

Faltenleghaken für Ring				Stück
	Kunststoff glasklar	36006 gk	0,10	

Flachring Ø20mm mit Kunststoffeinlage + FH				Stück
	poliert lackiert	848 201 p	3,60	
	verchromt	848 201 v	3,60	
	nickel matt	848 201 n	3,60	
	messing matt	848 201 m	3,60	

Faltenleghaken für Flachring				Stück
	Kunststoff glasklar	36003 gk	0,10	

Messingrohr, Ø20mm, Stange 5m			Meter
	poliert lackiert	ms 2006 p	57,60
	verchromt	ms 2006 v	57,60
	nickel matt	ms 2006 n	57,60
	messing matt	ms 2006 m	57,60

Rohrverbinder Ø20mm			Stück
	Metall/Kunststoff	1720	14,40

Alu Innenlauf-Profil Ø20mm, Stange 6m			Meter
	poliert lackiert	n90 620 p	63,50
	verchromt	n90 620 v	63,50
	nickel matt	n90 620 n	63,50
	messing matt	n90 620 m	63,50

Profilverbinder Messing			Stück
	vernickelt	904 071	12,-

Profilverbinder Messing, beliebiger Winkel			Stück
	vernickelt	904 072 - bw	28,80

Gehungsschnitt (ohne Profilverbinder)			Gehrung
	90°	1bg-1gs-90	20,-
	beliebiger Winkel	1bg-1gs-bw	49,-

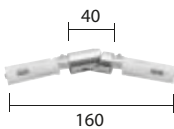
Gelenkverbinder Ø20mm				Stück
	poliert lackiert	8920 p	84,-	
	verchromt	8920 v	84,-	
	nickel matt	8920 n	84,-	
	messing matt	8920 m	84,-	

KLIXI-Drehgleiter 100 Stück			Beutel
	Kunststoff grau	2400 100 g	12,-
	Kunststoff weiß	2400 100 w	12,-

Gleiter 100 Stück			Beutel
	Kunststoff weiß	3942 100	5,40

Ösengleiter 100 Stück			Beutel
	Kunststoff weiß	3910 100	9,90

Gardinen-Doppelhaken 100 Stück			Beutel
	Kunststoff weiß	605 100	11,-

Roller mit Faltenleghaken			Stück
	Kunststoff weiß	2420	0,20

 Biegungen siehe Gruppe 10



mit Rohren aus
Reinmessing

Erkerausführung



Biegung



Gehrung



Gelenk

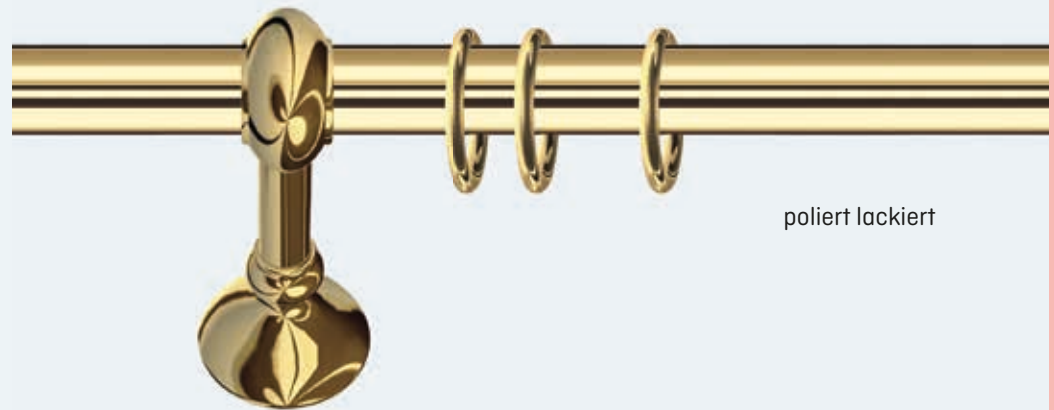

poliert lackiert

Messing
Ø20

Träger-
systeme

Farben Zubehör & Stangen



poliert lackiert

Geschlossene Wandträger Rund

Garnituren mit Geschlossenen Wandträgern Rund ohne Endknöpfe

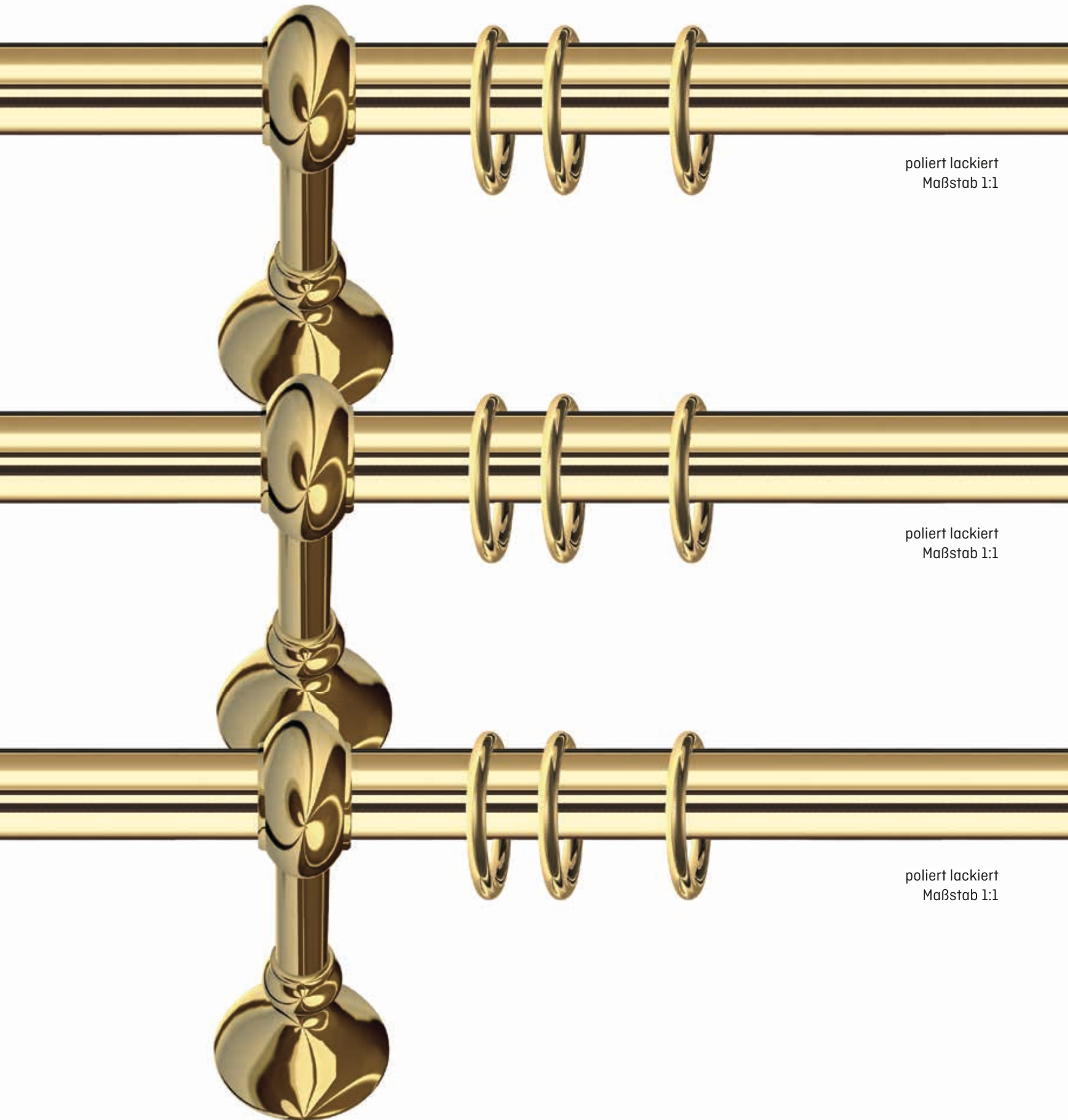

poliert lackiert
Maßstab 1:1

poliert lackiert
Maßstab 1:1

poliert lackiert
Maßstab 1:1

Lieferumfang

- ▶ **1 lfg:** 1 Reinmessing-Rohr Ø20mm oberflächenbehandelt, je nach Länge Wandträger und Ringe mit Faltenleghaken lt. Liste
- ▶ **2 lfg:** 2 Reinmessing-Rohre Ø20mm oberflächenbehandelt, je nach Länge Wandträger und Ringe mit Faltenleghaken lt. Liste, 2 Endkappen

- ▶ mit Montagematerial
- ▶ Bestellmaß = Rohrmaß
- ▶ Trägermitte bis Ringunterkante: 22mm
- ▶ bei geänderter Ausführung Aufpreis bzw. Preisänderung
- ▶ **Aus produktionstechnischen Gründen bestehen geringfügige Farbabweichungen zwischen den Karniesenkomponenten.**

Trägermaße

Träger 1-läufig:

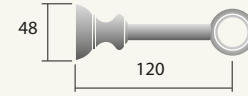

Träger 2-läufig:

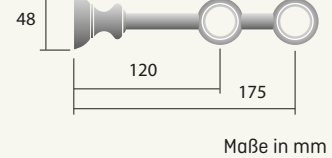

Maße in mm

			 poliert lackiert	
Bestellcode:			t20-061	t20-062
Länge (cm)	Wand-träger	Ringe 1l./2l.	1lfg ○	2lfg ○○
100	2	14/28	180	320
120	2	16/32	195	350
140	2	20/40	210	380
160	2	22/44	225	410
180	2	24/48	240	440
200	2	28/56	255	470
220	3	30/60	320	560
240	3	34/68	335	590
260	3	36/72	350	620
280	3	38/76	365	650
300	3	42/84	380	680
320	3	44/88	395	710
340	3	48/96	410	740
360	3	50/100	425	770
380	3	52/104	440	800
400	4	56/112	510	901
+ 20cm	▲	3/6	15	30
Preisänderung 1-seitig			-14,40	-8,40
bei Wandlager 2-seitig			-28,80	-16,80

▲ ab einer Länge von ca. 580 cm bzw. bei schwereren Vorhängen wird ein weiterer Träger empfohlen (Aufpreis)





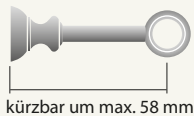

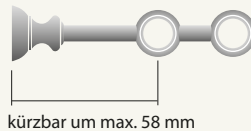

Träger kürzen: 19,-/Stück

Träger 1-läufig:

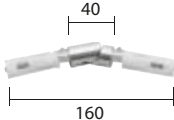
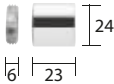

Träger 2-läufig:

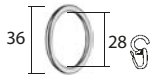

Wandträger 1lfg - Wandabstand 120mm	Stück		poliert lackiert	810 120 p	48,-	Messingrohr, Ø20mm, Stange 5m	Meter		poliert lackiert	ms 2006 p	57,60
Wandträger 2lfg - Wandabstand 120/175mm	Stück		poliert lackiert	810 220 p	60,-	Rohrverbinder Ø20mm	Stück		Metall/Kunststoff	1720	14,40
Endkappe Ø20mm	Stück		poliert lackiert	830 020 p	19,20	Gelenkverbinder Ø20mm	Stück		poliert lackiert	8920 p	84,-
Wandlager Ø20mm	Stück		poliert lackiert	82 320 p	38,40	Faltenleghaken für Flachring	Stück		Kunststoff glasklar	36003 gk	0,10
Ring Ø20mm + FH	Stück		poliert lackiert	840 201 p	2,90	Faltenleghaken für Ring	Stück		Kunststoff glasklar	36006 gk	0,10
Flachring Ø20mm mit Kunststoffeinlage + FH	Stück		poliert lackiert	848 201 p	3,60						

flIX

Ø28

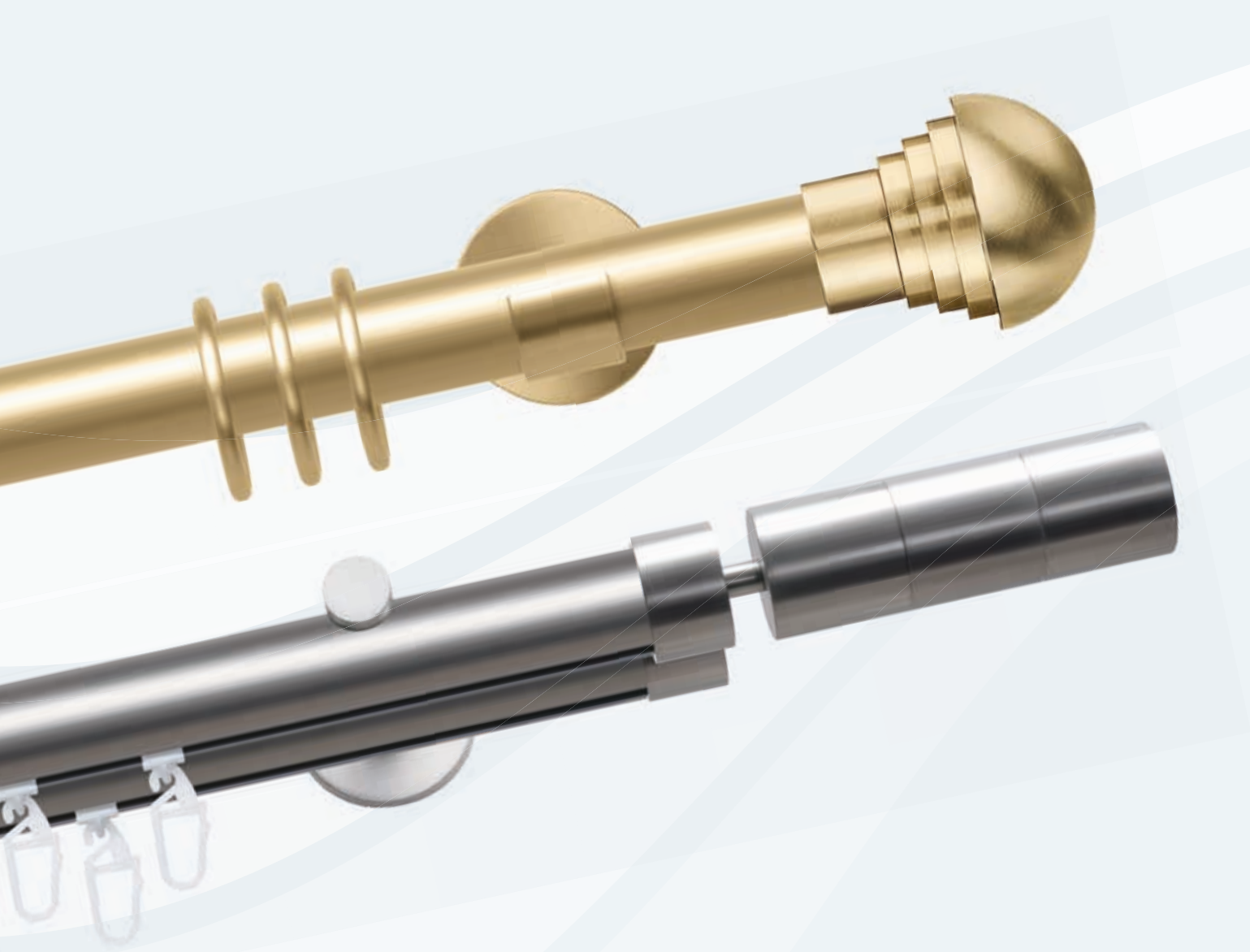

Messing
Ø28

Messing Ø28mm

Messing Ø28mm - Trägersysteme

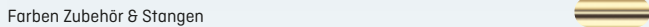
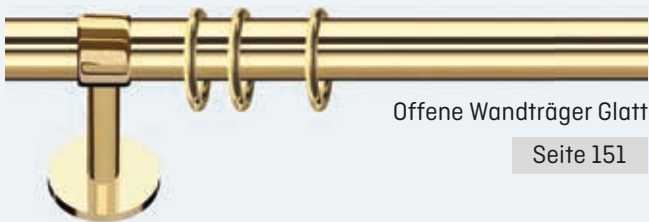
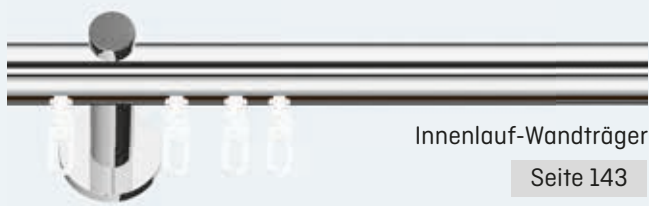

Messing Ø28mm - Endknöpfe

<p>Olymp flächenbündig</p> <p>Seite 129</p>	<p>Anna flächenbündig</p> <p>Seite 129</p>	<p>Sabine</p> <p>Seite 129</p>	<p>Pescara</p> <p>Seite 131</p>	<p>Bologna</p> <p>Seite 131</p>	<p>Perosa</p> <p>Seite 131</p>
<p>Alassio</p> <p>Seite 133</p>	<p>Cremona</p> <p>Seite 133</p>	<p>Köln</p> <p>Seite 133</p>	<p>Lava flächenbündig</p> <p>Seite 135</p>	<p>Napoli</p> <p>Seite 135</p>	<p>Verona</p> <p>Seite 135</p>
<p>Wien</p> <p>Seite 137</p>	<p>Paris</p> <p>Seite 137</p>	<p>Milano</p> <p>Seite 137</p>	<p>Strass</p> <p>Seite 139</p>		



Olymp
FLÄCHENBÜNDIG

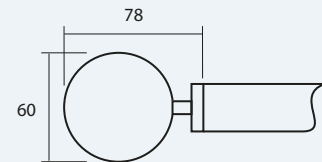

Anna
FLÄCHENBÜNDIG

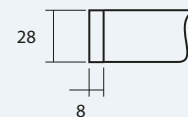

Sabine

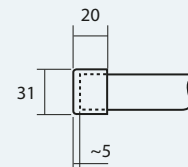

Endknöpfe Messing Ø28 mm

Olymp

FLÄCHENBÜNDIG



poliert lackiert



nickel matt



messing matt

verchromt
Maßstab 1:1

Endknopf Olymp		Stück
poliert lackiert	834 728 p	150,-
verchromt	834 728 v	150,-
messing matt	834 728 m	150,-
nickel matt	834 728 n	150,-

Anna

FLÄCHENBÜNDIG



verchromt



messing matt



nickel matt



poliert lackiert
Maßstab 1:1

Endknopf Anna		Stück
poliert lackiert	831 428 p	34,80
verchromt	831 428 v	34,80
messing matt	831 428 m	34,80
nickel matt	831 428 n	34,80

Sabine



poliert lackiert



messing matt



nickel matt



verchromt
Maßstab 1:1

Endknopf Sabine		Stück
poliert lackiert	830 028 p	22,80
verchromt	830 028 v	22,80
messing matt	830 028 m	22,80
nickel matt	830 028 n	22,80

Leichte Farbunterschiede zwischen Stange, Endknöpfen und Wandträger können aus produktionstechnischen Gründen auftreten.



Pescara

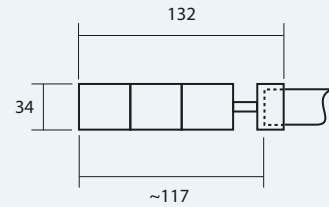

Bologna

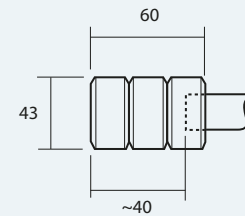

Perosa

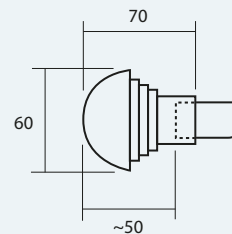

Endknöpfe Messing Ø28 mm

Pescara



Endknopf Pescara		Stück
poliert lackiert	834 528 p	114,-
verchromt	834 528 v	114,-
nickel matt	834 528 n	114,-
messing matt	834 528 m	114,-

messing matt, Maßstab 1:1



poliert lackiert

verchromt

nickel matt

Bologna



poliert lackiert



nickel matt



messing matt



Endknopf Bologna		Stück
poliert lackiert	832 728 p	114,-
verchromt	832 728 v	114,-
messing matt	832 728 m	114,-
nickel matt	832 728 n	114,-

verchromt, Maßstab 1:1

Perosa



poliert lackiert



verchromt



nickel matt



messing matt
Maßstab 1:1

Endknopf Perosa		Stück
poliert lackiert	832 628 p	150,-
verchromt	832 628 v	150,-
messing matt	832 628 m	150,-
nickel matt	832 628 n	150,-

Leichte Farbunterschiede zwischen Stange, Endknöpfen und Wandträger können aus produktionstechnischen Gründen auftreten.

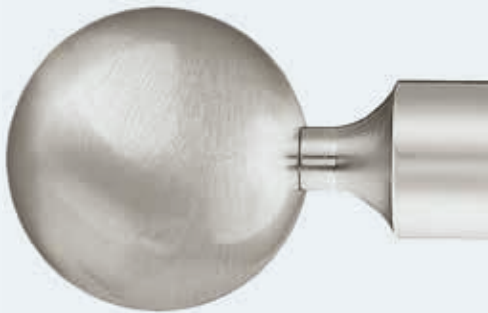

Alassio

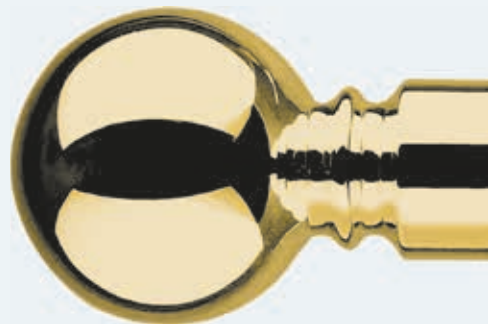
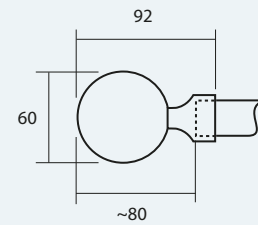

Cremona

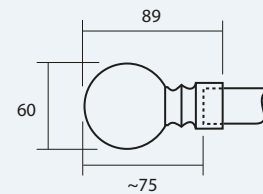

Köln

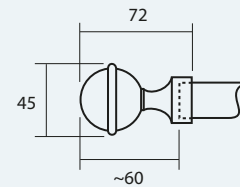

Endknöpfe Messing Ø28 mm

Messing
Ø28

Alassio

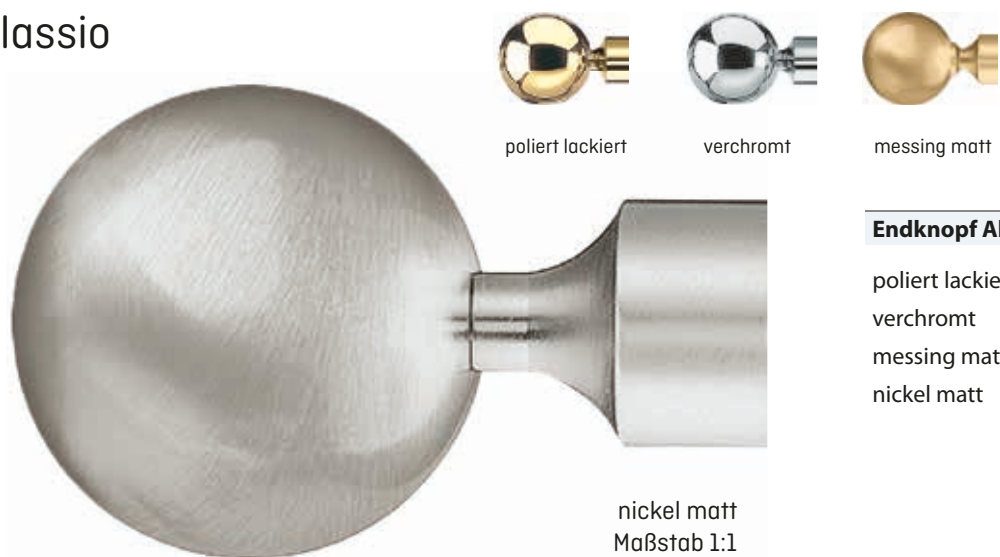

Endknopf Alassio		Stück
poliert lackiert	832 328 p	150,-
verchromt	832 328 v	150,-
messing matt	832 328 m	150,-
nickel matt	832 328 n	150,-

Cremona

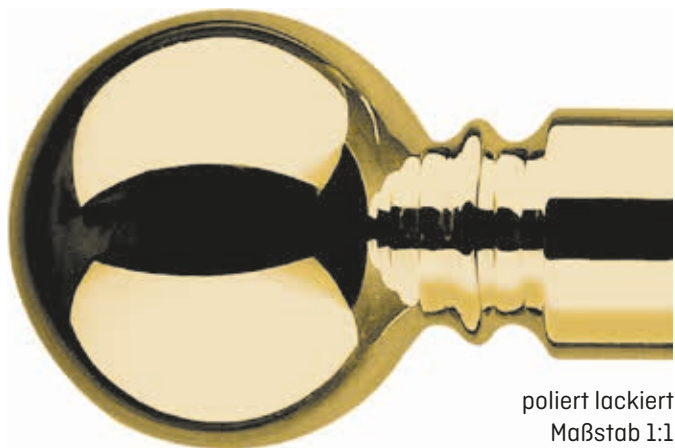

Endknopf Cremona		Stück
poliert lackiert	830 428 p	60,-

Köln

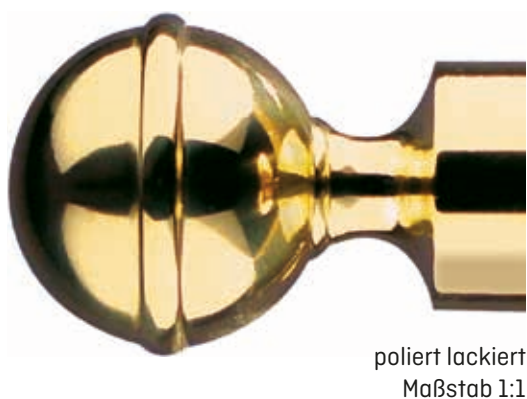

Endknopf Köln		Stück
poliert lackiert	830 528 p	41,-

Leichte Farbunterschiede zwischen Stange, Endknöpfen und Wandträger können aus produktionstechnischen Gründen auftreten.

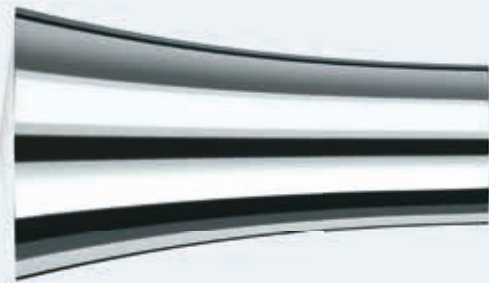

Lava
FLÄCHENBÜNDIG

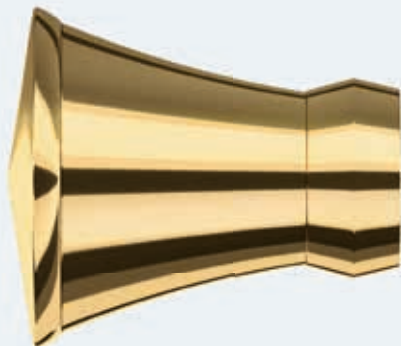
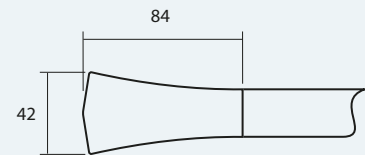

Napoli

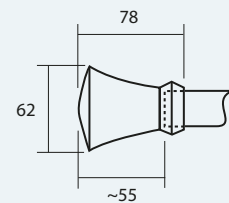

Verona

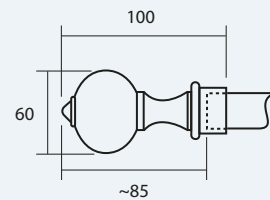

Endknöpfe Messing Ø28 mm

Lava

FLÄCHENBÜNDIG



poliert lackiert



messing matt







nickel matt



verchromt
Maßstab 1:1

Endknopf Lava

Stück

poliert lackiert		831 029 p	114,-
verchromt		831 029 v	114,-
messing matt		831 029 m	114,-
nickel matt		831 029 n	114,-

Napoli

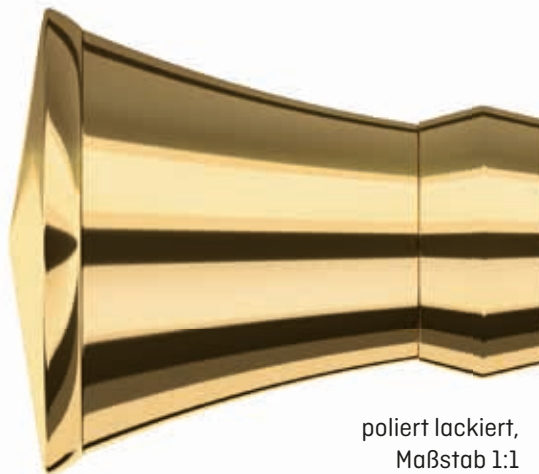

poliert lackiert,
Maßstab 1:1

Endknopf Napoli

Stück

poliert lackiert		835 128 p	174,-
------------------	---	-----------	-------

Verona



poliert lackiert
Maßstab 1:1

Endknopf Verona

Stück

poliert lackiert		832 428 p	174,-
------------------	---	-----------	-------

Leichte Farbunterschiede zwischen Stange, Endknöpfen und Wandträger können aus produktionstechnischen Gründen auftreten.



Wien

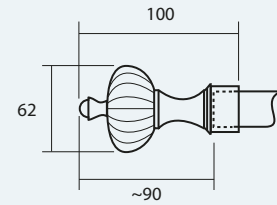

Paris

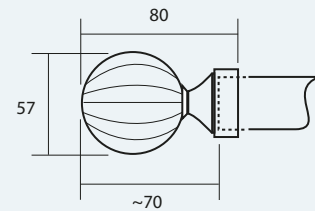

Milano

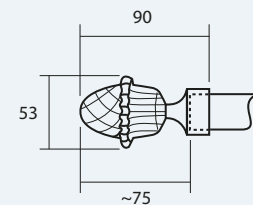

Endknöpfe Messing Ø28 mm

Wien



Endknopf Wien Stück
poliert lackiert  832 228 p 234,-

Paris



Endknopf Paris Stück
poliert lackiert  831 128 p 70,-

Milano



Endknopf Milano Stück
poliert lackiert  831 028 p 47,-

Leichte Farbunterschiede zwischen Stange, Endknöpfen und Wandträger können aus produktionstechnischen Gründen auftreten.



Strass

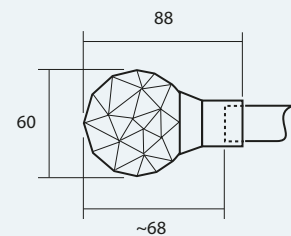





Endknöpfe Messing Ø28 mm

Strass



poliert lackiert/
Strass-Kristall
Maßstab 1:1

Endknopf Strass		Stück
poliert lackiert	 837 523 p	199,-
verchromt	 837 523 v	202,-
messing matt	 837 523 m	199,-
nickel matt	 837 523 n	202,-



verchromt



nickel matt



messing matt

Leichte Farbunterschiede zwischen Stange, Endknöpfen und Wandträger können aus produktionstechnischen Gründen auftreten.

flüX

Ø28

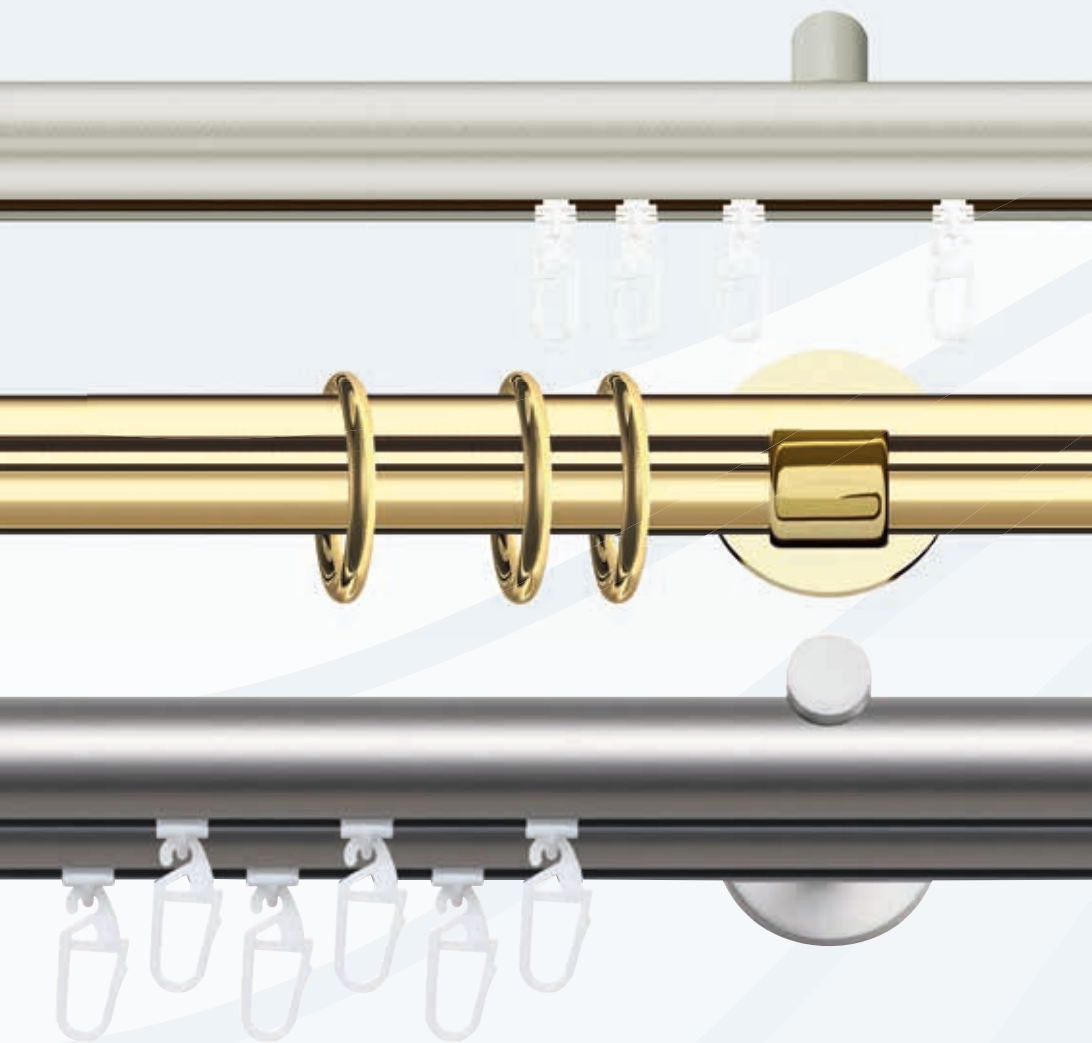

Messing Ø28mm Trägersysteme

Messing
Ø28

Träger-
systeme

Messing Ø28mm - Trägersysteme

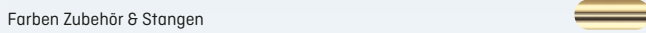
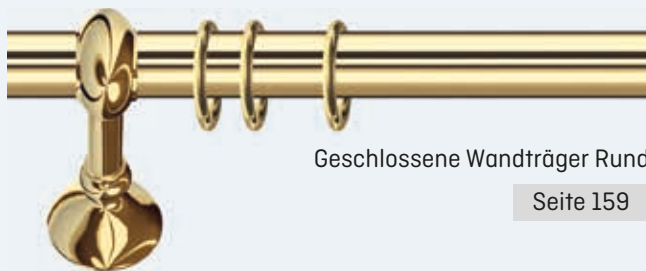
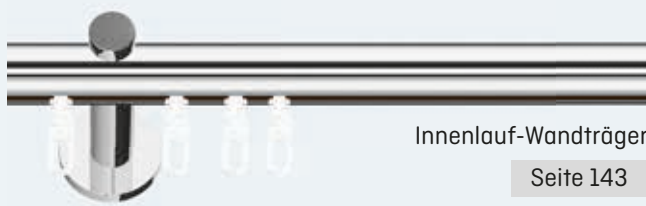

KLIXI® mit KLIXI Drehgleiter

Erkerausführung

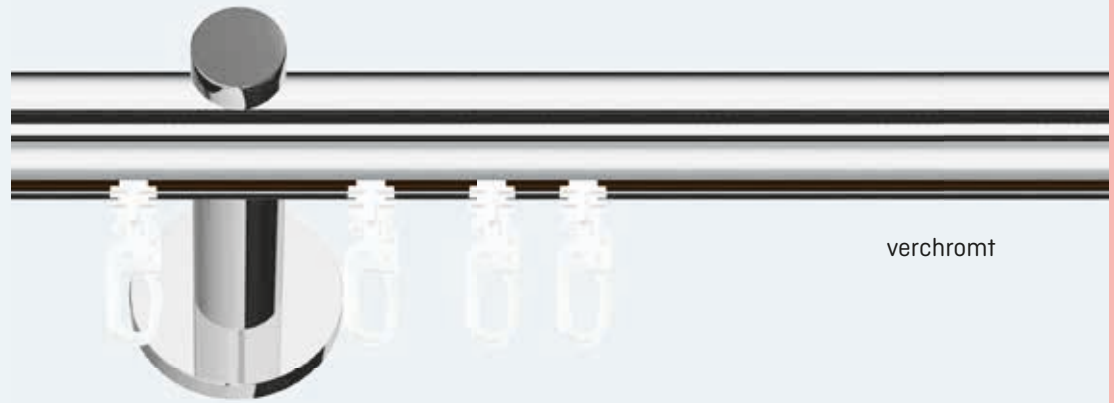

verchromt

Farben Zubehör



poliert lackiert



verchromt



messing matt



nickel matt

Farben Innenlauf-Profile



poliert lackiert



verchromt



messing matt



nickel matt



wildeiche*



zwetschke*



schwarz matt

* IL-Profile in wildeiche, zwetschke: Laufroller Art. 2420

Messing
Ø28

Träger-
systeme

Innenlauf-Wandträger

Garnituren mit Innenlaufträgern ohne Endknöpfe



nickel matt
Maßstab 1:1





verchromt
Maßstab 1:1



poliert lackiert
Maßstab 1:1

Lieferumfang

- ▶ **1 lfg:** 1 Alu Innenlauf-Profil Ø28mm oberflächenbehandelt, je nach Länge Wandträger und -Drehgleiter lt. Liste
- ▶ **2 lfg:** 2 Alu Innenlauf-Profile Ø28mm oberflächenbehandelt, je nach Länge Wandträger und -Drehgleiter lt. Liste, 2 Endkappen

- ▶ mit Montagematerial
- ▶ Bestellmaß = Profilmaß
- ▶ Trägermitte bis Rohrunterkante: 28mm
- ▶ **auch mit Motor möglich, in den Profildesign-Farben verchromt, nickel matt, schwarz matt – Preis auf Anfrage** 
- ▶ bei geänderter Ausführung Aufpreis bzw. Preisänderung
- ▶ **Aus produktionstechnischen Gründen bestehen geringfügige Farbabweichungen zwischen den Karniesenkomponenten.**
- ▶ **IL-Profile in wildeiche, zwetschke: nur Laufroller Art. 2420 ohne Aufpreis**

Trägermaße



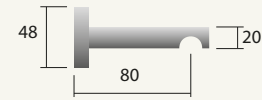



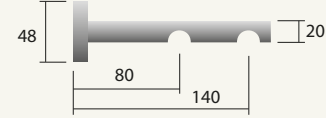









Träger 1-läufig:



Träger 2-läufig:



Maße in mm

											Preisänderung für IL-Profil in:	
Bestellcode:			t28-021	t28-022	t28-039	t28-040	t28-031	t28-032	t28-035	t28-036	 wildeiche  zwetschke  schwarz matt	
Länge (cm)	Wand-träger	Gleiter 1l./2l.	1lfg 	2lfg 	1lfg 	2lfg 	1lfg 	2lfg 	1lfg 	2lfg 	1lfg 	2lfg 
100	2	16/32	215	363	215	367	215	367	215	367	-26	-52
120	2	18/36	230	394	230	398	230	398	230	398	-31	-62
140	2	22/44	245	425	245	429	245	429	245	429	-36	-72
160	2	26/52	260	456	260	460	260	460	260	460	-41	-82
180	2	28/54	275	487	275	491	275	491	275	491	-46	-92
200	2	32/64	290	518	290	522	290	522	290	522	-51	-102
220	2	34/68	305	549	305	553	305	553	305	553	-56	-112
240	3	38/76	392	661	392	665	392	665	392	665	-61	-122
260	3	42/84	407	692	407	696	407	696	407	696	-66	-132
280	3	44/88	422	723	422	727	422	727	422	727	-71	-142
300	3	48/96	437	754	437	758	437	758	437	758	-76	-152
320	3	50/100	452	785	452	789	452	789	452	789	-81	-162
340	3	54/108	467	816	467	820	467	820	467	820	-86	-172
360	3	58/116	482	847	482	851	482	851	482	851	-91	-182
380	3	60/120	497	878	497	882	497	882	497	882	-96	-192
400	3	64/128	512	909	512	913	512	913	512	913	-101	-202
+ 20 cm		3/6	15	31	15	31	15	31	15	31	-5	-10
Preisänderung bei Wandlager	1-seitig		-24,70	-15,60	-24,70	-17,70	-24,70	-17,70	-24,70	-17,70		
	2-seitig		-49,50	-31,30	-49,50	-35,30	-49,50	-35,30	-49,50	-35,30		

▲ ab einer Länge von ca. 420 cm bzw. bei schwereren Vorhängen wird ein weiterer Träger empfohlen (Aufpreis)

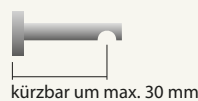

Träger kürzen: 19,-/Stück

Träger 1-läufig:



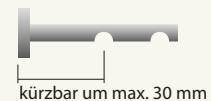

Träger 2-läufig:

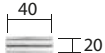
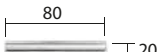

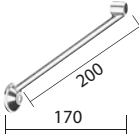

Träger und passende Verlängerungen				
Wandträger 1lfg - Wandabstand 80mm				
	poliert lackiert	871 058 p	70,80	Stück
	verchromt	871 058 v	70,80	
	nickel matt	871 058 n	70,80	
	messing matt	871 058 m	70,80	
	Wandträger 2lfg - Wandabstand 80/140mm			
	poliert lackiert	871 143 p	86,40	Stück
	verchromt	871 143 v	86,40	
	nickel matt	871 143 n	86,40	
	messing matt	871 143 m	86,40	
	Wandträger 2lfg - Wandabstand 90/190mm			
	poliert lackiert	871 144 p	112,80	Stück
	verchromt	871 144 v	112,80	
	nickel matt	871 144 n	112,80	
	messing matt	871 144 m	112,80	
	Trägerverlängerung 40mm			
	poliert lackiert	871 040 p	25,20	Stück
	verchromt	871 040 v	25,20	
	nickel matt	871 040 n	25,20	
	messing matt	871 040 m	25,20	
Trägerverlängerung 80mm				
	poliert lackiert	871 060 p	30,-	Stück
	verchromt	871 060 v	30,-	
	nickel matt	871 060 n	30,-	
	messing matt	871 060 m	30,-	

Trägerstütze				
	poliert lackiert	810 7290 p	57,60	Stück
	verchromt	810 7290 v	57,60	
	nickel matt	810 7290 n	57,60	
	messing matt	810 7290 m	57,60	

Endkappe flächenbündig Anna Ø28mm				
	poliert lackiert	831 428 p	34,80	Stück
	verchromt	831 428 v	34,80	
	nickel matt	831 428 n	34,80	
	messing matt	831 428 m	34,80	

Endkappe Ø28mm			
	poliert lackiert	830 028 p	22,80
	verchromt	830 028 v	22,80
	nickel matt	830 028 n	22,80
	messing matt	830 028 m	22,80

Wandlager Ø28mm			
	poliert lackiert	82 328 p	45,60
	verchromt	82 328 v	45,60
	nickel matt	82 328 n	45,60
	messing matt	82 328 m	45,60

Alu Innenlauf-Profil Ø28mm, Stange 6m			
	poliert lackiert	n90 628 p	81,40
	verchromt	n90 628 v	81,40
	nickel matt	n90 628 n	81,40
	messing matt	n90 628 m	81,40
	wildeiche	n90 628 wi	55,20
	zwetschke	n90 628 zw	55,20
	schwarz matt	n90 628 sm	52,40

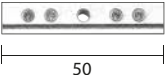
Profilverbinder Messing			
	vernickelt	904 071	12,-

Profilverbinder Messing, beliebiger Winkel			
	vernickelt	904 072 - bw	28,80

Gehungsschnitt (ohne Profilverbinder)			
	90°	1bg-1gs-90	20,-
	beliebiger Winkel	1bg-1gs-bw	49,-

KLIXI-Drehgleiter 100 Stück			
	Kunststoff grau	2400 100 g	12,-
	Kunststoff weiß	2400 100 w	12,-

Gleiter 100 Stück			
	Kunststoff weiß	3942 100	5,40

Roller mit Faltenleghaken			
	Kunststoff weiß	2420	0,20

Roller mit Kugellager			
	Kunststoff	904 074	1,10

 Biegungen siehe Gruppe 10

KLIXI® mit KLIXI Drehgleiter

Erkerausführung



Biegung



Gehrung



Gelenk

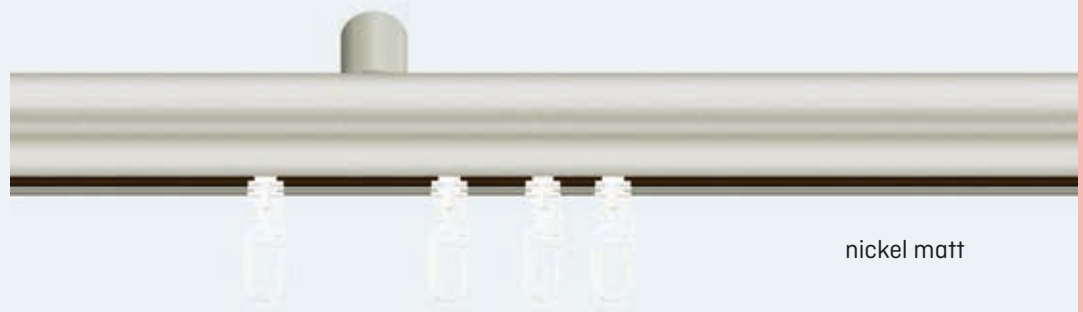

nickel matt

Farben Zubehör



poliert lackiert



verchromt



messing matt



nickel matt

Farben Innenlauf-Profile



poliert lackiert



verchromt



messing matt



nickel matt



wildeiche*



zwetschke*



schwarz matt

* IL-Profile in wildeiche, zwetschke: Laufroller Art. 2420

Messing
Ø28

Träger-
systeme

Innenlauf-Deckenträger

Garnituren mit Innenlauf-Deckenträgern ohne Endknöpfe

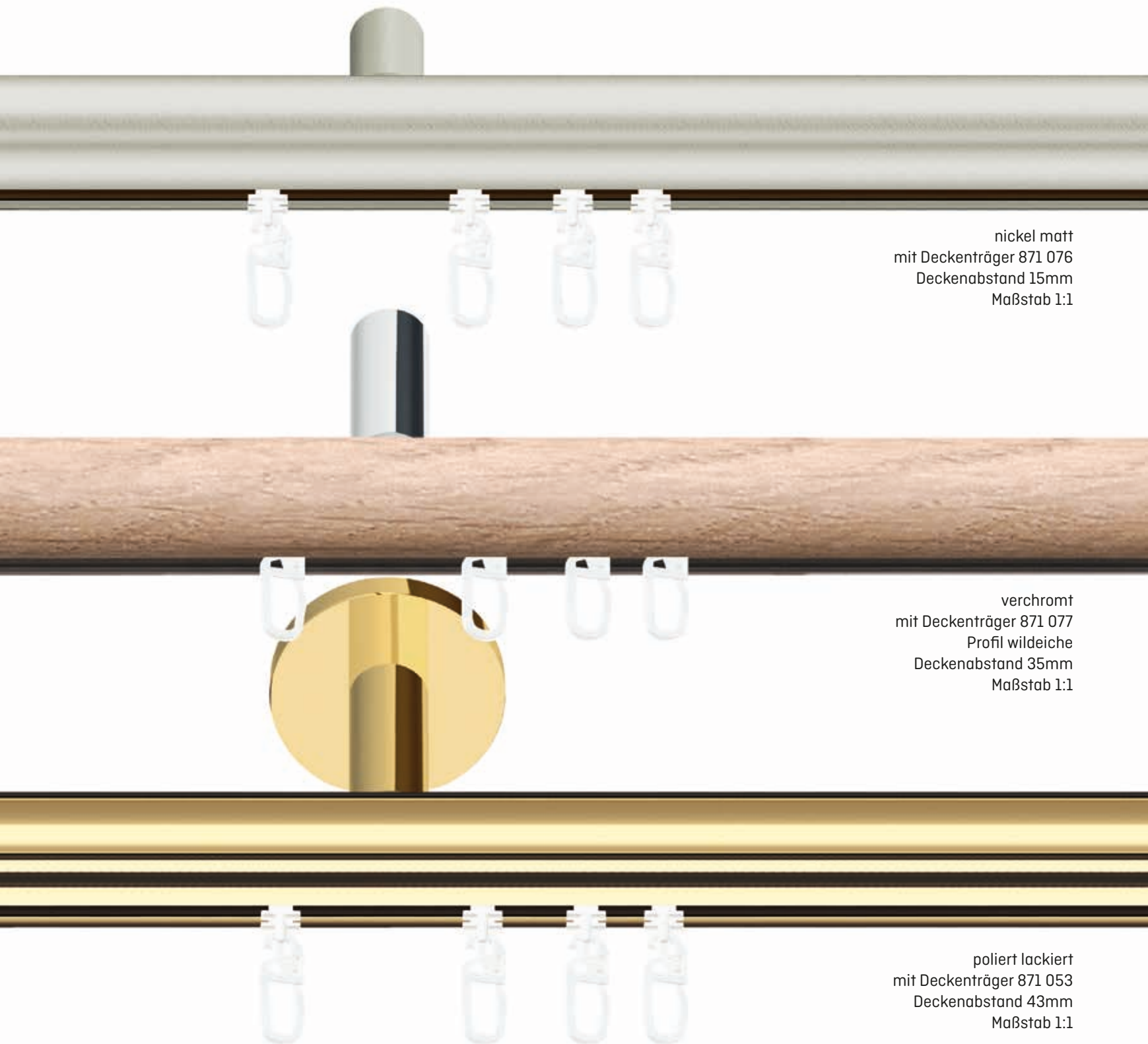



nickel matt
mit Deckenträger 871 076
Deckenabstand 15mm
Maßstab 1:1

verchromt
mit Deckenträger 871 077
Profil wildeiche
Deckenabstand 35mm
Maßstab 1:1

poliert lackiert
mit Deckenträger 871 053
Deckenabstand 43mm
Maßstab 1:1

Lieferumfang

- ▶ **1 lfg mit Deckenträger 15mm Deckenabstand:**
1 Alu Innenlauf-Profil Ø28mm oberflächenbehandelt, je nach Länge Deckenträger und -Drehgleiter lt. Liste
- ▶ **1 lfg mit Deckenträger 35mm Deckenabstand:**
1 Alu Innenlauf-Profil Ø28mm oberflächenbehandelt, je nach Länge Deckenträger und -Drehgleiter lt. Liste
- ▶ **1 lfg mit Deckenträger 43mm Deckenabstand:**
1 Alu Innenlauf-Profil Ø28mm oberflächenbehandelt, je nach Länge Deckenträger und -Drehgleiter lt. Liste

- ▶ mit Montagematerial
- ▶ Bestellmaß = Profilmaß
- ▶ Decke bis Innenlauf-Profilunterkante: siehe Maßskizzen rechts
- ▶ **auch mit Motor möglich, in den Profilmontage-Farben verchromt, nickel matt, schwarz matt – Preis auf Anfrage**
- ▶ bei geänderter Ausführung Aufpreis bzw. Preisabschlag
- ▶ **Aus produktionstechnischen Gründen bestehen geringfügige Farbabweichungen zwischen den Karniesenkomponenten.**
- ▶ **IL-Profile in wildeiche, zwetschke: nur Laufroller Art. 2420 ohne Aufpreis**



Trägermaße

Träger 1-läufig Art. 871 076
Deckenabstand 15mm:

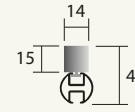

Träger 1-läufig Art. 871 077
Deckenabstand 35mm:

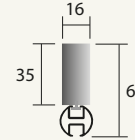

Träger 1-läufig Art. 871 053
Deckenabstand 43mm:

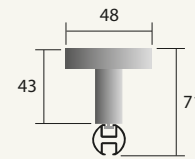

Maße in mm

Bestellcode:	poliert lackiert		verchromt		nickel matt		messing matt							Preisänderung für IL-Profil in:	
	t28-304	t28-305	t28-306	t28-307	t28-308	t28-309	t28-310	t28-311	t28-312	t28-313	t28-314	t28-315			
Länge															
Decken-träger															
Gleiter															
1lfg															
100	2	16	126	138	175	126	138	175	126	138	175	126	138	175	-26
120	2	18	141	153	190	141	153	190	141	153	190	141	153	190	-31
140	2	22	156	168	205	156	168	205	156	168	205	156	168	205	-36
160	2	26	171	183	220	171	183	220	171	183	220	171	183	220	-41
180	2	28	186	198	235	186	198	235	186	198	235	186	198	235	-46
200	2	32	201	213	250	201	213	250	201	213	250	201	213	250	-51
220	2	34	216	228	265	216	228	265	216	228	265	216	228	265	-56
240	3	38	257	275	332	257	275	332	257	275	332	257	275	332	-61
260	3	42	272	290	347	272	290	347	272	290	347	272	290	347	-66
280	3	44	287	305	362	287	305	362	287	305	362	287	305	362	-71
300	3	48	302	320	377	302	320	377	302	320	377	302	320	377	-76
320	3	50	317	335	392	317	335	392	317	335	392	317	335	392	-81
340	3	54	332	350	407	332	350	407	332	350	407	332	350	407	-86
360	3	58	347	365	422	347	365	422	347	365	422	347	365	422	-91
380	3	60	362	380	437	362	380	437	362	380	437	362	380	437	-96
400	3	64	377	395	452	377	395	452	377	395	452	377	395	452	-101
+ 20 cm	▲	3	15	15	15	15	15	15	15	15	15	15	15	15	-5

▲ ab einer Länge von ca. 420 cm bzw. bei schwereren Vorhängen wird ein weiterer Träger empfohlen (Aufpreis)

Messing
Ø28

Träger-
systeme

Träger und passende Verlängerungen				
Deckenträger, Deckenabstand 35mm				
	poliert lackiert	871 077 p	31,20	Stück
	verchromt	871 077 v	31,20	
	nickel matt	871 077 n	31,20	
	messing matt	871 077 m	31,20	
Deckenträger 1lfg., Deckenabstand 43mm/Ø16mm				
	poliert lackiert	871 053 p	50,40	Stück
	verchromt	871 053 v	50,40	
	nickel matt	871 053 n	50,40	
	messing matt	871 053 m	50,40	
Deckenträger 2lfg., Deckenabstand 53mm/Ø16mm				
	poliert lackiert	871 153 p	81,60	Stück
	verchromt	871 153 v	81,60	
	nickel matt	871 153 n	81,60	
	messing matt	871 153 m	81,60	
Trägerverlängerung für Wand-/Deckenträger, 40mm				
	poliert lackiert	871 044 p	21,60	Stück
	verchromt	871 044 v	21,60	
	nickel matt	871 044 n	21,60	
	messing matt	871 044 m	21,60	
Trägerverlängerung für Wand-/Deckenträger, 80mm				
	poliert lackiert	871 066 p	24,-	Stück
	verchromt	871 066 v	24,-	
	nickel matt	871 066 n	24,-	
	messing matt	871 066 m	24,-	

Deckenträger, Deckenabstand 15mm				
	poliert lackiert	871 076 p	25,20	Stück
	verchromt	871 076 v	25,20	
	nickel matt	871 076 n	25,20	
	messing matt	871 076 m	25,20	
Endkappe flächenbündig Anna Ø28mm				
	poliert lackiert	831 428 p	34,80	Stück
	verchromt	831 428 v	34,80	
	nickel matt	831 428 n	34,80	
	messing matt	831 428 m	34,80	

Endkappe Ø28mm				
	poliert lackiert	830 028 p	22,80	Stück
	verchromt	830 028 v	22,80	
	nickel matt	830 028 n	22,80	
	messing matt	830 028 m	22,80	

Wandlager Ø28mm				
	poliert lackiert	82 328 p	45,60	Stück
	verchromt	82 328 v	45,60	
	nickel matt	82 328 n	45,60	
	messing matt	82 328 m	45,60	

Alu Innenlauf-Profil Ø28mm, Stange 6m				
	poliert lackiert	n90 628 p	81,40	Meter
	verchromt	n90 628 v	81,40	
	nickel matt	n90 628 n	81,40	
	messing matt	n90 628 m	81,40	
	wildeiche	n90 628 wi	55,20	
	zwetschke	n90 628 zw	55,20	
	schwarz matt	n90 628 sm	52,40	

Profilverbinder Messing				
	vernickelt	904 071	12,-	Stück

Profilverbinder Messing, beliebiger Winkel				
	vernickelt	904 072 - bw	28,80	Stück

Gehungsschnitt (ohne Profilverbinder)				
	90°	1bg-1gs-90	20,-	Gehrung
	beliebiger Winkel	1bg-1gs-bw	49,-	

KLIXI-Drehgleiter 100 Stück				
	Kunststoff grau	2400 100 g	12,-	Beutel
	Kunststoff weiß	2400 100 w	12,-	

Gleiter 100 Stück				
	Kunststoff weiß	3942 100	5,40	Beutel

Roller mit Faltenleghaken				
	Kunststoff weiß	2420	0,20	Stück

Roller mit Kugellager				
	Kunststoff	904 074	1,10	Stück

Biegungen siehe Gruppe 10



mit Rohren aus
Reinmessing

Erkerausführung



Biegung



Gehrung



Gelenk

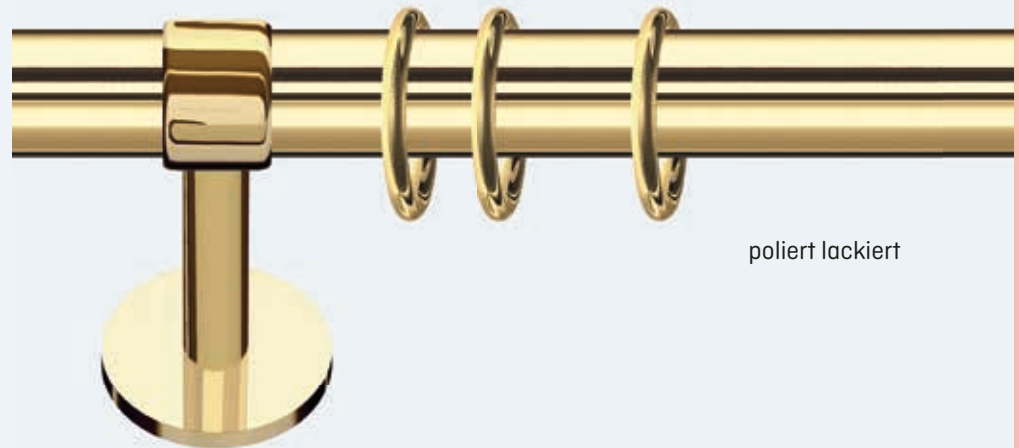

poliert lackiert

Farben Zubehör & Stangen



poliert lackiert



verchromt



messing matt



nickel matt

Offene Wandträger Glatt

Garnituren mit Offenen Wandträgern Glatt ohne Endknöpfe

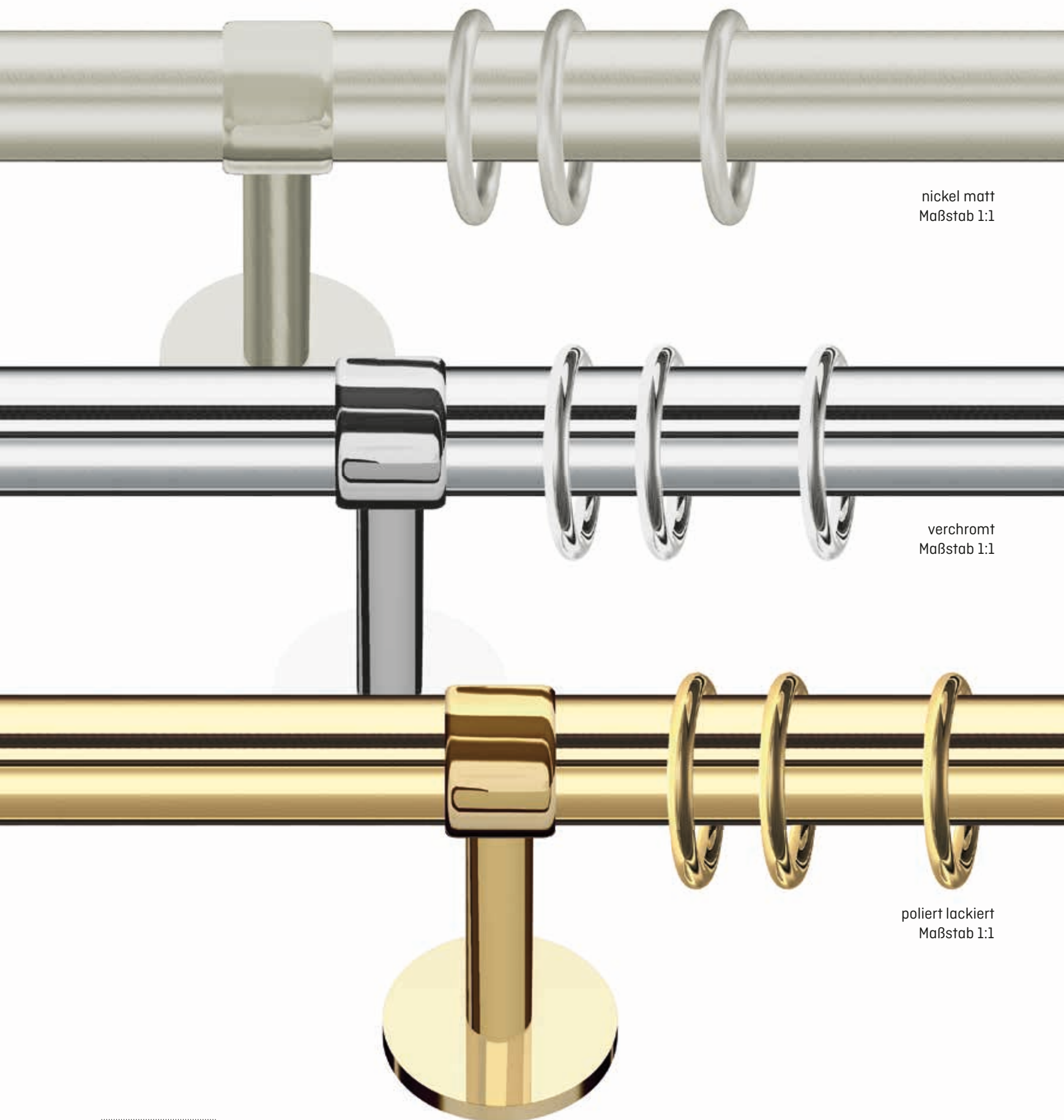

nickel matt
Maßstab 1:1

verchromt
Maßstab 1:1

poliert lackiert
Maßstab 1:1

Lieferumfang

- ▶ **1 lfg:** 1 Reinmessing-Rohr Ø28mm oberflächenbehandelt, je nach Länge Wandträger und Ringe mit Faltenleghaken lt. Liste
- ▶ **2 lfg:** 1 Reinmessing-Rohr Ø28mm oberflächenbehandelt, 1 Messing-Rohr Ø20mm, je nach Länge Wandträger und Ringe mit Faltenleghaken lt. Liste, 2 Endkappen

- ▶ mit Montagematerial
- ▶ Bestellmaß = Rohrmaß
- ▶ Trägermitte bis Ringunterkante Ø20: 22mm
- ▶ Trägermitte bis Ringunterkante Ø28: 28mm
- ▶ bei geänderter Ausführung Aufpreis bzw. Preisänderung
- ▶ **Aus produktionstechnischen Gründen bestehen geringfügige Farbabweichungen zwischen den Karniesenkomponenten.**

Trägermaße

Träger 1-läufig:

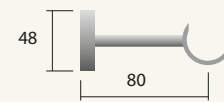

Träger 2-läufig:

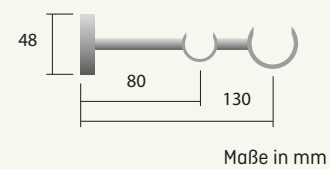

Maße in mm

Bestellcode:				t28-007	t28-008	t28-009	t28-010	t28-001	t28-002	t28-005	t28-006		
Länge (cm)	Wandträger		Ringe 1l./2l.	1lfg		2lfg		1lfg		2lfg			
	1lfg	2lfg		○	○○	○	○○	○	○○	○	○○		
100	2	2	14/28	290	520	290	520	290	520	290	520		
120	2	2	16/32	314	558	314	558	314	558	314	558		
140	2	2	20/40	338	596	338	596	338	596	338	596		
160	2	2	22/44	362	634	362	634	362	634	362	634		
180	2	2	24/48	386	672	386	672	386	672	386	672		
200	2	2	28/56	410	710	410	710	410	710	410	710		
220	2	3	30/60	434	740	434	740	434	740	434	740		
240	3	3	34/68	544	778	544	778	544	778	544	778		
260	3	3	36/72	568	816	568	816	568	816	568	816		
280	3	3	38/76	592	854	592	854	592	854	592	854		
300	3	3	42/84	616	892	616	892	616	892	616	892		
320	3	3	44/88	640	930	640	930	640	930	640	930		
340	3	3	48/96	664	968	664	968	664	968	664	968		
360	3	3	50/100	688	1.006	688	1.006	688	1.006	688	1.006		
380	3	3	52/104	712	1.044	712	1.044	712	1.044	712	1.044		
400	3	4	56/112	736	1.233	736	1.233	736	1.233	736	1.233		
+ 20cm ▲			3/6	24	38	24	38	24	38	24	38		
Preisänderung bei Wandlager			1-seitig	-39,20	-83,30	-39,20	-83,30	-39,20	-83,30	-39,20	-83,30		
			2-seitig	-78,40	-166,50	-78,40	-166,50	-78,40	-166,50	-78,40	-166,50		

▲ 1-läufig: ab einer Länge von ca. 420 cm bzw. bei schwereren Vorhängen wird ein weiterer Träger empfohlen (Aufpreis)

▲ 2-läufig: ab einer Länge von ca. 580 cm bzw. bei schwereren Vorhängen wird ein weiterer Träger empfohlen (Aufpreis)

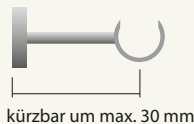

Träger kürzen: 19,-/Stück

Träger 1-läufig:



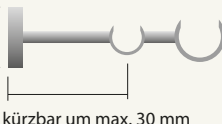

Träger 2-läufig:

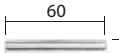

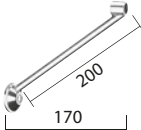
Träger und passende Verlängerungen			
Wandträger 1lfg - Wandabstand 80mm			
	poliert lackiert	810 728 p	92,-
	verchromt	810 728 v	92,-
	nickel matt	810 728 n	83,70
	messing matt	810 728 m	83,70
Wandträger 2lfg - Wandabstand 80/130mm			
	poliert lackiert	810 828 p	141,90
	verchromt	810 828 v	141,90
	nickel matt	810 828 n	127,30
	messing matt	810 828 m	127,30
Trägerverlängerung 40mm			
	poliert lackiert	810 014 - 40 p	19,20
	verchromt	810 014 - 40 v	19,20
	nickel matt	810 014 - 40 n	19,20
	messing matt	810 014 - 40 m	19,20
Trägerverlängerung 60mm			
	poliert lackiert	810 014 - 60 p	24,-
	verchromt	810 014 - 60 v	24,-
	nickel matt	810 014 - 60 n	24,-
	messing matt	810 014 - 60 m	24,-

Trägerstütze			
	poliert lackiert	810 7291 p	55,20
	verchromt	810 7291 v	55,20
	nickel matt	810 7291 n	55,20
	messing matt	810 7291 m	55,20

Endkappe Ø20mm			
	poliert lackiert	830 020 p	19,20
	verchromt	830 020 v	19,20
	nickel matt	830 020 n	19,20
	messing matt	830 020 m	19,20

Endkappe flächenbündig Anna Ø28mm			
	poliert lackiert	831 428 p	34,80
	verchromt	831 428 v	34,80
	nickel matt	831 428 n	34,80
	messing matt	831 428 m	34,80

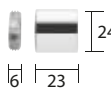
Wandlager Ø20mm			
	poliert lackiert	82 320 p	38,40
	verchromt	82 320 v	38,40
	nickel matt	82 320 n	38,40
	messing matt	82 320 m	38,40

Wandlager Ø28mm			
	poliert lackiert	82 328 p	45,60
	verchromt	82 328 v	45,60
	nickel matt	82 328 n	45,60
	messing matt	82 328 m	45,60

Ring Ø20mm + FH			
	poliert lackiert	840 201 p	2,90
	verchromt	840 201 v	2,90
	nickel matt	840 201 n	2,90
	messing matt	840 201 m	2,90

Flachring Ø20mm mit Kunststoffeinlage + FH			
	poliert lackiert	848 201 p	3,60
	verchromt	848 201 v	3,60
	nickel matt	848 201 n	3,60
	messing matt	848 201 m	3,60

Ring Ø28mm + FH			
	poliert lackiert	840 281 p	4,60
	verchromt	840 281 v	4,60
	nickel matt	840 281 n	4,60
	messing matt	840 281 m	4,60

Ring Ø28mm mit Kunststoffeinlage + FH			
	poliert lackiert	842 281 p	4,90
	verchromt	842 281 v	4,90
	nickel matt	842 281 n	4,90
	messing matt	842 281 m	4,90

Flachring Ø28mm mit Kunststoffeinlage + FH			
	poliert lackiert	848 281 p	4,90
	verchromt	848 281 v	4,90
	nickel matt	848 281 n	4,90
	messing matt	848 281 m	4,90

Messingrohr, Ø20mm, Stange 5m			
	poliert lackiert	ms 2006 p	57,60
	verchromt	ms 2006 v	57,60
	nickel matt	ms 2006 n	57,60
	messing matt	ms 2006 m	57,60

Messingrohr, Ø28mm, Stange 5m			
	poliert lackiert	ms 2810 p	74,70
	verchromt	ms 2810 v	74,70
	nickel matt	ms 2810 n	74,70
	messing matt	ms 2810 m	74,70

Rohrverbinder Metall/Kunststoff			
	Ø20mm	1720	14,40
	Ø28mm	1728	15,60

Gelenkverbinder Ø20mm			
	poliert lackiert	8920 p	84,-
	verchromt	8920 v	84,-
	nickel matt	8920 n	84,-
	messing matt	8920 m	84,-

Gelenkverbinder Ø28mm			
	poliert lackiert	8928 p	90,-
	verchromt	8928 v	90,-
	nickel matt	8928 n	90,-
	messing matt	8928 m	90,-

Faltenleghaken für Flachring Ø20 und Ø28mm			
	Kunststoff glasklar	36003 gk	0,10

Faltenleghaken für Ring Ø20 und Ø28mm			
	Kunststoff glasklar	36006 gk	0,10

KLIXI® mit KLIXI Drehgleiter



Dekorlauf mit Rohr aus Reinmessing

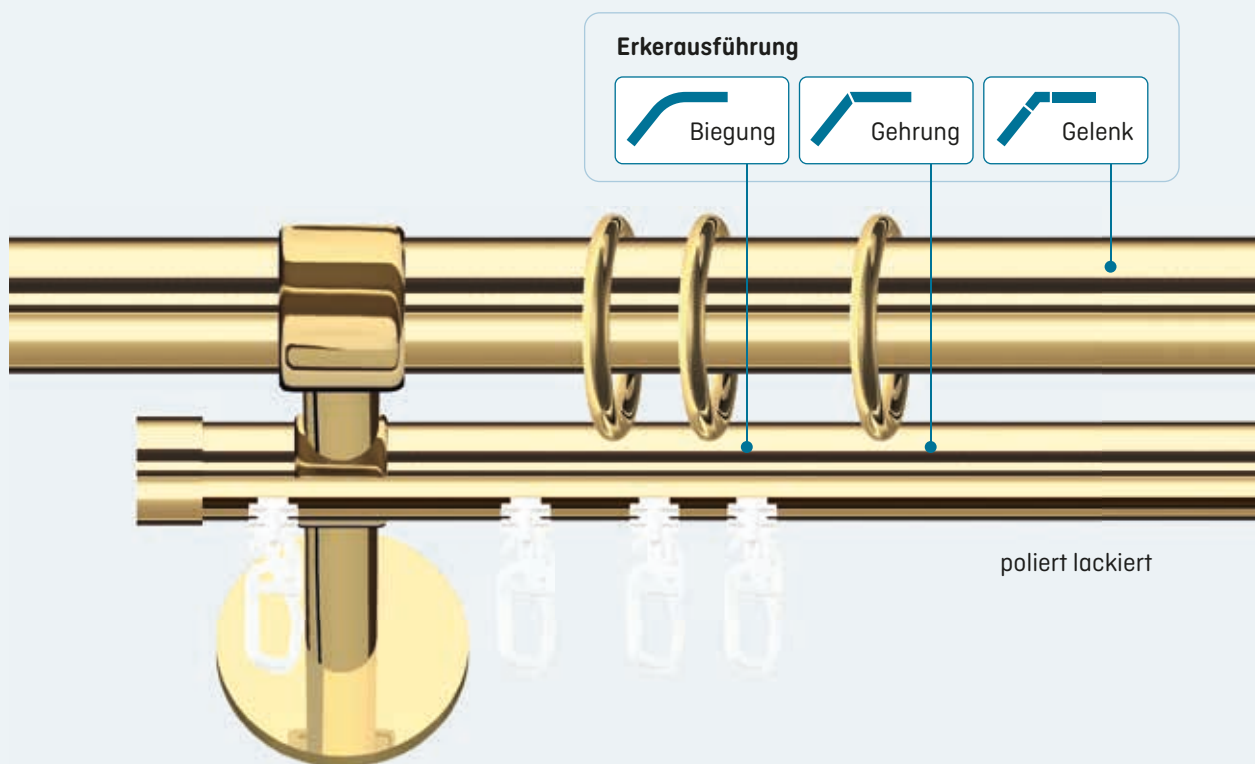

Farben Zubehör & Stangen



poliert lackiert



verchromt



messing matt



nickel matt

Messing
Ø28

Träger-
systeme

Offene Wandträger Glatt

Storeschiene mit Alu-Innenlauf-Profil

Garnituren: Storeschiene mit Alu-Innenlauf-Profil ohne Endknöpfe

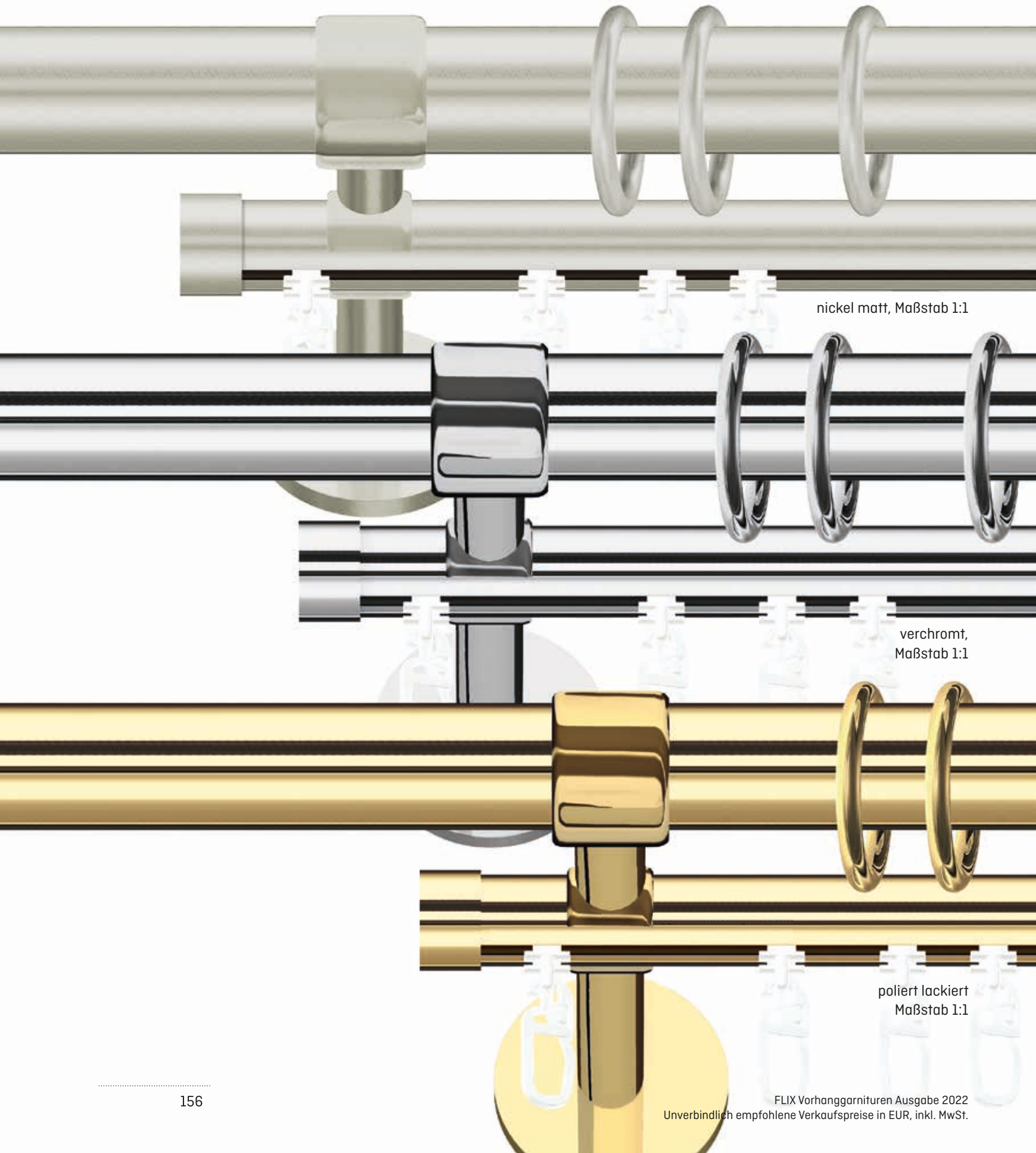







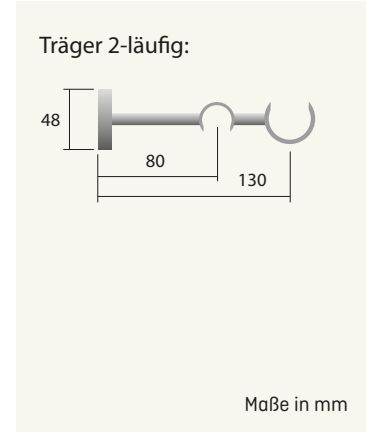

Lieferumfang

- ▶ 1 Reinnessing-Rohr Ø28mm oberflächenbehandelt, 1 Alu Innenlauf-Profil Ø20mm oberflächenbehandelt, je nach Länge Wandträger und Ringe mit Faltenleghaken und -Drehgleiter lt. Liste, 2 Endkappen
- ▶ mit Montagematerial
- ▶ Bestellmaß = Rohr-/Profilmaß
- ▶ Trägermitte bis Ringunterkante Rohr Ø28: 28mm
- ▶ Trägermitte bis Innenlaufprofil-Unterkante: 10mm
- ▶ bei geänderter Ausführung Aufpreis bzw. Preisänderung
- ▶ **Aus produktionstechnischen Gründen bestehen geringfügige Farbabweichungen zwischen den Karniesenkomponenten.**

Trägermaße



						
Bestellcode:			t28-049	t28-050	t28-046	t28-048
Länge (cm)	Wand-träger	Ringe/Gleiter	2lfg 	2lfg 	2lfg 	2lfg 
100	2	14/16	483	483	483	483
120	2	16/18	516	516	516	516
140	2	20/22	549	549	549	549
160	2	22/26	582	582	582	582
180	2	24/28	615	615	615	615
200	2	28/32	648	648	648	648
220	3	30/34	674	674	674	674
240	3	34/38	707	707	707	707
260	3	36/42	740	740	740	740
280	3	38/44	773	773	773	773
300	3	42/48	806	806	806	806
320	3	44/50	839	839	839	839
340	3	48/54	872	872	872	872
360	3	50/58	905	905	905	905
380	3	52/60	938	938	938	938
400	4	56/64	1.256	1.256	1.256	1.256
+ 20cm	▲	3/6	33	33	33	33
Preisänderung bei Wandlager	1-seitig		-62,80	-62,80	-62,80	-62,80
	2-seitig		-125,70	-125,70	-125,70	-125,70

▲ ab einer Länge von ca. 580 cm bzw. bei schwereren Vorhängen wird ein weiterer Träger empfohlen (Aufpreis)

Träger kürzen: 19,-/Stück

Träger 2-läufig:

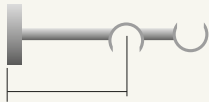



kürzbar um max. 30mm

Messing
Ø28

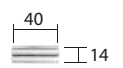
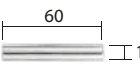
Träger-
systeme

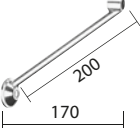
Träger und passende Verlängerungen			
Wandträger 2lfg - Wandabstand 80/130mm			
	poliert lackiert	810 829 p	142,50
	verchromt	810 829 v	142,50
	nickel matt	810 829 n	128,20
	messing matt	810 829 m	128,20
Trägerverlängerung 40mm			
	poliert lackiert	810 014 - 40 p	19,20
	verchromt	810 014 - 40 v	19,20
	nickel matt	810 014 - 40 n	19,20
	messing matt	810 014 - 40 m	19,20
Trägerverlängerung 60mm			
	poliert lackiert	810 014 - 60 p	24,-
	verchromt	810 014 - 60 v	24,-
	nickel matt	810 014 - 60 n	24,-
	messing matt	810 014 - 60 m	24,-

Trägerstütze			
	poliert lackiert	810 7291 p	55,20
	verchromt	810 7291 v	55,20
	nickel matt	810 7291 n	55,20
	messing matt	810 7291 m	55,20

Endkappe Ø20mm			
	poliert lackiert	830 020 p	19,20
	verchromt	830 020 v	19,20
	nickel matt	830 020 n	19,20
	messing matt	830 020 m	19,20

Endkappe flächenbündig Anna Ø20mm			
	poliert lackiert	831 420 p	28,80
	verchromt	831 420 v	28,80
	nickel matt	831 420 n	28,80
	messing matt	831 420 m	28,80

Wandlager Ø20mm			
	poliert lackiert	82 320 p	38,40
	verchromt	82 320 v	38,40
	nickel matt	82 320 n	38,40
	messing matt	82 320 m	38,40

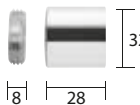
Wandlager Ø28mm			
	poliert lackiert	82 328 p	45,60
	verchromt	82 328 v	45,60
	nickel matt	82 328 n	45,60
	messing matt	82 328 m	45,60

Ring Ø28mm + FH			
	poliert lackiert	840 281 p	4,60
	verchromt	840 281 v	4,60
	nickel matt	840 281 n	4,60
	messing matt	840 281 m	4,60

Ring Ø28mm mit Kunststoffeinlage + FH			
	poliert lackiert	842 281 p	4,90
	verchromt	842 281 v	4,90
	nickel matt	842 281 n	4,90
	messing matt	842 281 m	4,90

Faltenleghaken für Ring			
	Kunststoff glasklar	36006 gk	0,10

Flachring Ø28mm mit Kunststoffeinlage + FH			
	poliert lackiert	848 281 p	4,90
	verchromt	848 281 v	4,90
	nickel matt	848 281 n	4,90
	messing matt	848 281 m	4,90

Faltenleghaken für Flachring			
	Kunststoff glasklar	36003 gk	0,10

Messingrohr, Ø28mm, Stange 5m			
	poliert lackiert	ms 2810 p	74,70
	verchromt	ms 2810 v	74,70
	nickel matt	ms 2810 n	74,70
	messing matt	ms 2810 m	74,70

Rohrverbinder Ø28mm			
	Metall/Kunststoff	1728	15,60

Alu Innenlauf-Profil Ø20mm, Stange 6m			
	poliert lackiert	n90 620 p	63,50
	verchromt	n90 620 v	63,50
	nickel matt	n90 620 n	63,50
	messing matt	n90 620 m	63,50

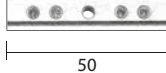
Profilverbinder Messing			
	vernickelt	904 071	12,-

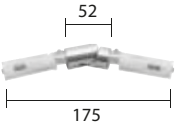
Gelenkverbinder Ø28mm			
	poliert lackiert	8928 p	90,-
	verchromt	8928 v	90,-
	nickel matt	8928 n	90,-
	messing matt	8928 m	90,-

Profilverbinder Messing, beliebiger Winkel			
	vernickelt	904 072 - bw	28,80

Gehungsschnitt (ohne Profilverbinder)			
	90°	1bg-1gs-90	20,-
	beliebiger Winkel	1bg-1gs-bw	49,-

KLIXI-Drehgleiter 100 Stück			
	Kunststoff grau	2400 100 g	12,-
	Kunststoff weiß	2400 100 w	12,-

Gleiter 100 Stück			
	Kunststoff weiß	3942 100	5,90

Roller mit Faltenleghaken			
	Kunststoff weiß	2420	0,20

 Biegungen siehe Gruppe 10



mit Rohren aus
Reinmessing

Erkerausführung



Biegung



Gehrung



Gelenk

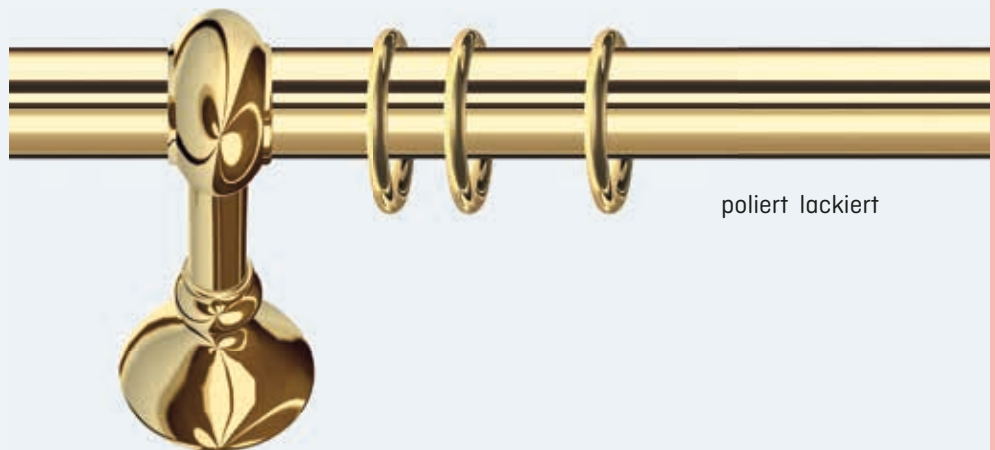

poliert lackiert

Farben Zubehör & Stangen



poliert lackiert

Messing
Ø28

Träger-
systeme

Geschlossene Wandträger Rund

Garnituren mit Geschlossenen Wandträgern Rund ohne Endknöpfe

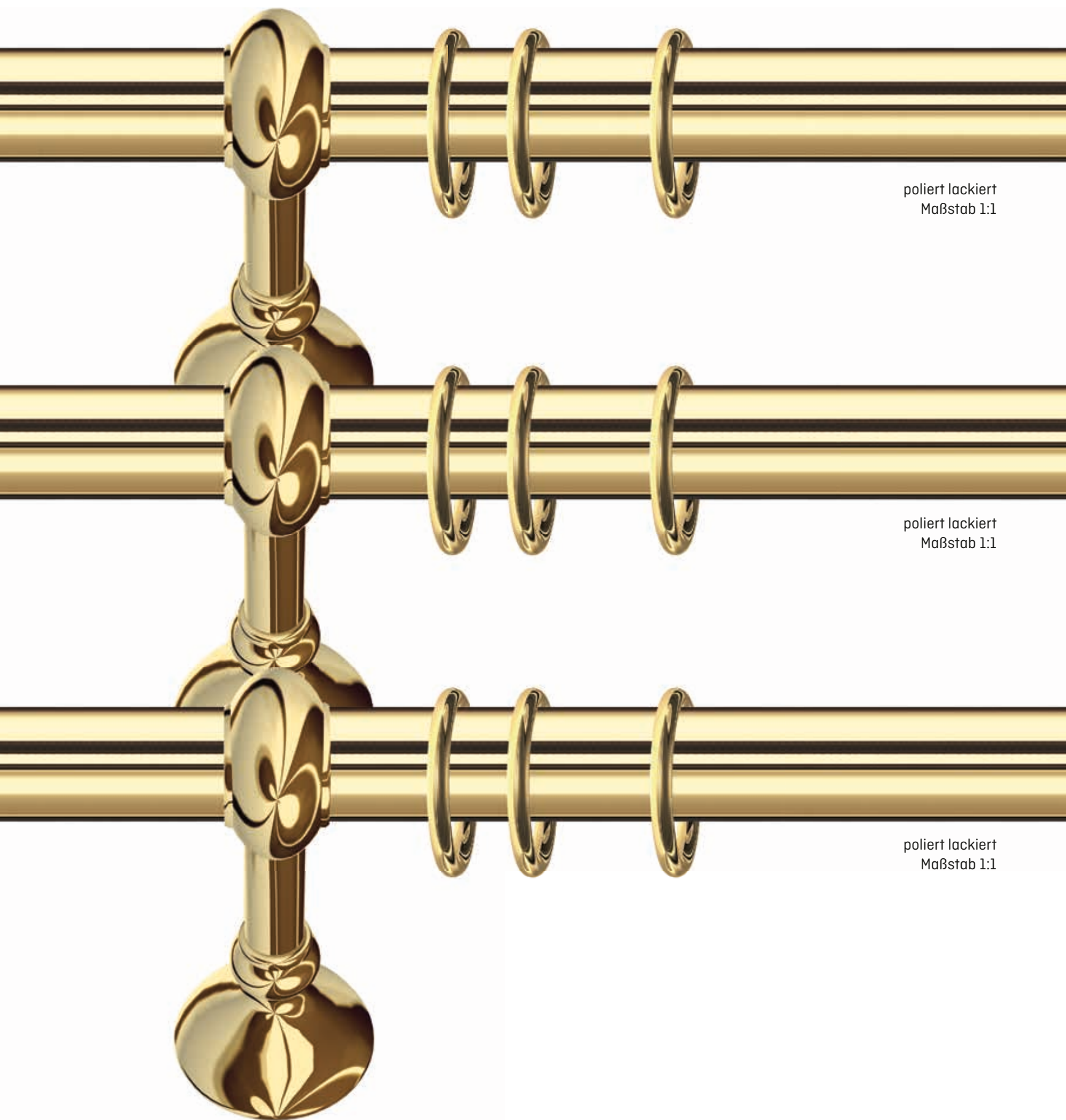

poliert lackiert
Maßstab 1:1

poliert lackiert
Maßstab 1:1

poliert lackiert
Maßstab 1:1

Lieferumfang

▶ **1 lfg:** 1 Reinmessing-Rohr Ø28mm oberflächenbehandelt, je nach Länge Wandträger und Ringe mit Faltenleghaken lt. Liste

- ▶ mit Montagematerial
- ▶ Bestellmaß = Rohrmaß
- ▶ Trägermitte bis Ringunterkante: 28mm
- ▶ bei geänderter Ausführung Aufpreis bzw. Preisänderung
- ▶ **Aus produktionstechnischen Gründen bestehen geringfügige Farbabweichungen zwischen den Karniesenkomponenten.**

Trägermaße

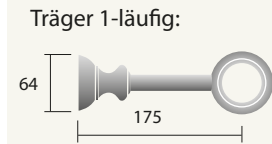

Maße in mm

			 poliert lackiert
Bestellcode:			t28-017
Länge (cm)	Wand-träger	Ringe 1l.	1lfg ○
100	2	14	254
120	2	16	277
140	2	20	300
160	2	22	323
180	2	24	346
200	2	28	369
220	2	30	392
240	3	34	485
260	3	36	508
280	3	38	531
300	3	42	554
320	3	44	577
340	3	48	600
360	3	50	623
380	3	52	646
400	3	56	669
+ 20cm	▲	3	23
Preisänderung 1-seitig			-25,90
bei Wandlager 2-seitig			-51,80

▲ ab einer Länge von ca. 420 cm bzw. bei schwereren Vorhängen wird ein weiterer Träger empfohlen (Aufpreis)

Träger kürzen: 19,-/Stück



Messing
Ø28

Träger-
systeme

Wandträger 1fg - Wandabstand 175mm Stück

 poliert lackiert 810 128 p 72,-

Messingrohr, Ø28mm, Stange 5m Meter

 poliert lackiert ms 2810 p 74,70

Trägerstütze Stück

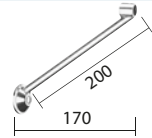
 poliert lackiert 810 7291 p 55,20

Rohrverbinder Ø28mm Stück

 Metall/Kunststoff 1728 15,60

Endkappe Ø28mm Stück

 poliert lackiert 830 028 p 22,80

Gelenkverbinder Stück

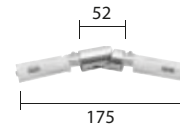
 poliert lackiert 8928 p 90,-

Wandlager Ø28mm Stück

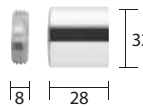
 poliert lackiert 82 328 p 45,60

Faltenleghaken für Flachring Stück

 Kunststoff glasklar 36003 gk 0,10

Ring Ø28mm + FH Stück

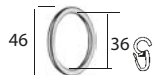
 poliert lackiert 840 281 p 4,60

Faltenleghaken für Ring Stück

 Kunststoff glasklar 36006 gk 0,10

Ring Ø28mm mit Kunststoffeinlage + FH Stück

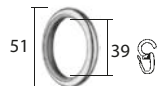
 poliert lackiert 842 281 p 4,60

Flachring Ø28mm mit Kunststoffeinlage + FH Stück

 poliert lackiert 848 281 p 4,90



Aluminium

Aluminium Ø20 mm

Übersicht	Seite 166
Endknöpfe	Seite 167
Innenlauf-Wandträger	Seite 175
Innenlauf-Deckenträger	Seite 179
Offene Wandträger Rund	Seite 183
Offene Wandträger Rund, Storeschiene mit Alu-Innenlauf-Profil	Seite 183

Aluminium Ø28 mm

Übersicht	Seite 188
Endknöpfe	Seite 189
Innenlauf-Wandträger	Seite 195
Innenlauf-Deckenträger	Seite 199
Offene Wandträger Rund	Seite 203

OOOOO
FLIX

Ø20



Aluminium
Ø20

Aluminium Ø20mm

Aluminium Ø20 mm - Trägersysteme



Farben Zubehör



Farben Stangen

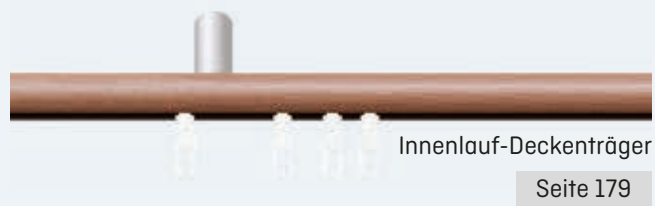
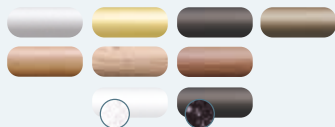

Farben Zubehör



Farben Stangen

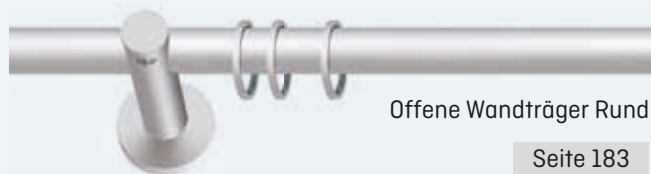

Farben Zubehör & Stangen



Farben Zubehör & Stangen



Aluminium Ø20 mm - Endknöpfe



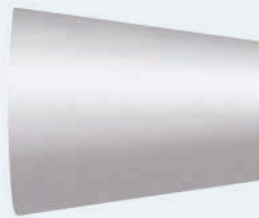

Theo
FLÄCHENBÜNDIG

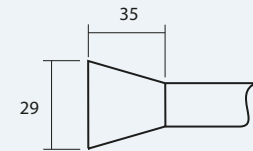

Siena

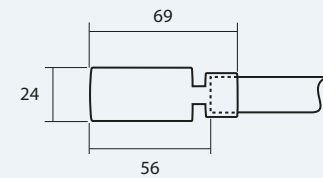

Hestia
FLÄCHENBÜNDIG

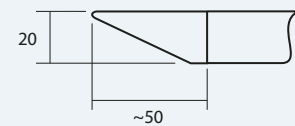

Endknöpfe Aluminium Ø20 mm

Theo

FLÄCHENBÜNDIG

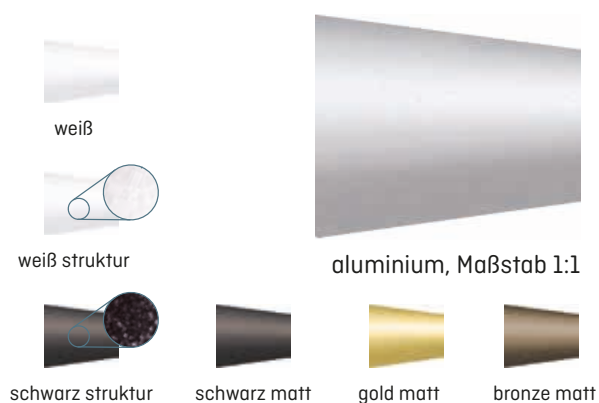

Endknopf Theo		Stück
aluminium	831 820 a	30,-
gold matt	831 820 gm	32,40
schwarz matt	831 820 sm	30,-
bronze matt	831 820 bm	32,40
weiß	831 820 w	30,-
weiß struktur	831 820 ws	30,-
schwarz struktur	831 820 ss	30,-

Siena



Endknopf Siena		Stück
aluminium	835 820 a	40,80
gold matt	835 820 gm	40,80
schwarz matt	835 820 sm	40,80
bronze matt	835 820 bm	40,80
weiß	835 820 w	40,80
weiß struktur	835 820 ws	40,80
schwarz struktur	835 820 ss	40,80

Hestia

FLÄCHENBÜNDIG



Endknopf Hestia		Stück
aluminium	832 820 a	30,-
schwarz matt	832 820 sm	30,-
weiß	832 820 w	30,-

Leichte Farbunterschiede zwischen Stange, Endknöpfen und Wandträger können aus produktionstechnischen Gründen auftreten.



Finn
FLÄCHENBÜNDIG

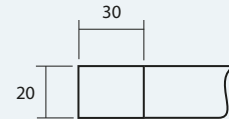

Anna
FLÄCHENBÜNDIG

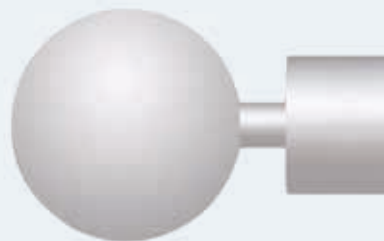
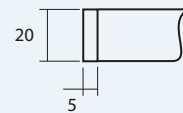

Modica

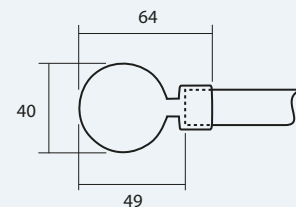

Endknöpfe Aluminium Ø20 mm

Finn

FLÄCHENBÜNDIG

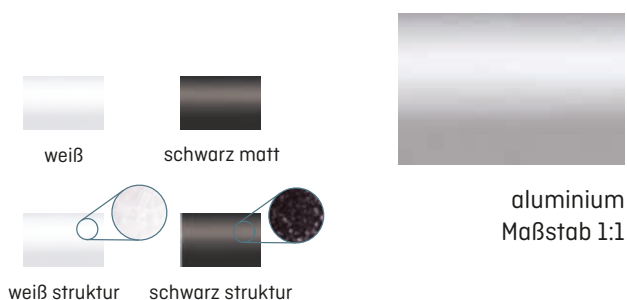

Endknopf Finn		Stück
aluminium	831 720 a	30,-
schwarz matt	831 720 sm	30,-
weiß	831 720 w	30,-
weiß struktur	831 720 ws	30,-
schwarz struktur	831 720 ss	30,-

Anna

FLÄCHENBÜNDIG



Endknopf Anna		Stück
aluminium	831 420 a	22,80
gold matt	831 420 gm	25,20
schwarz matt	831 420 sm	22,80
bronze matt	831 420 bm	25,20
verchromt	831 420 v	28,80
weiß	831 420 w	22,80
weiß struktur	831 420 ws	22,80
schwarz struktur	831 420 ss	22,80

Modica

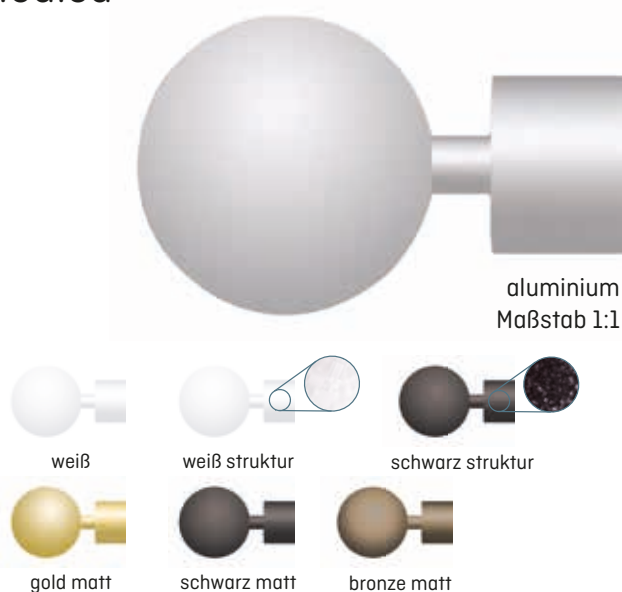

Endknopf Modica		Stück
aluminium	835 920 a	40,80
gold matt	835 920 gm	44,40
schwarz matt	835 920 sm	40,80
bronze matt	835 920 bm	44,40
weiß	835 920 w	40,80
weiß struktur	835 920 ws	40,80
schwarz struktur	835 920 ss	40,80

Leichte Farbunterschiede zwischen Stange, Endknöpfen und Wandträger können aus produktionstechnischen Gründen auftreten.



Pan

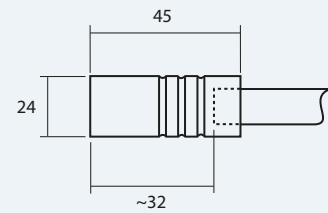

Catania

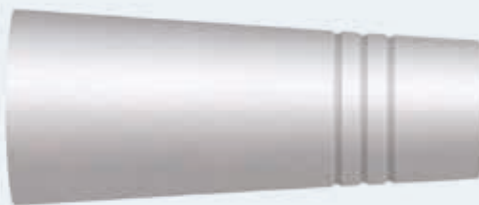
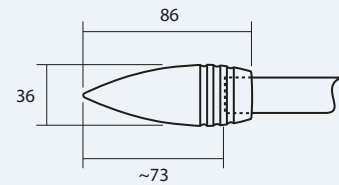

Padua

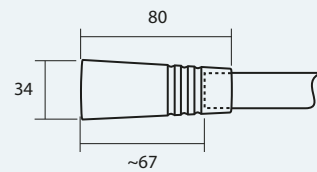

Endknöpfe Aluminium Ø20 mm

Pan

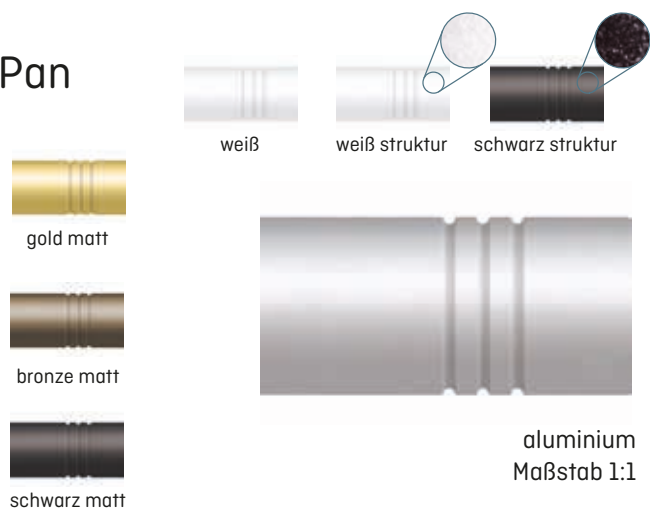

Endknopf Pan		Stück
aluminium	837 821 a	28,80
gold matt	837 821 gm	31,20
schwarz matt	837 821 sm	28,80
bronze matt	837 821 bm	31,20
weiß	837 821 w	28,80
weiß struktur	837 821 ws	28,80
schwarz struktur	837 821 ss	28,80

Catania

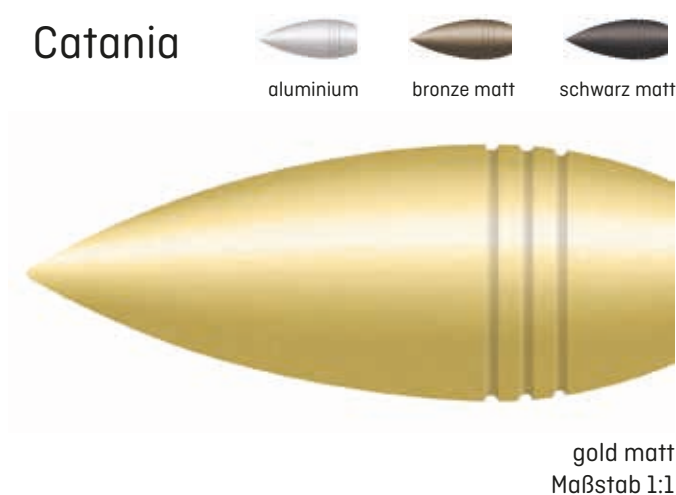

Endknopf Catania		Stück
aluminium	850 120 a	37,20
gold matt	850 120 gm	39,60
schwarz matt	850 120 sm	37,20
bronze matt	850 120 bm	39,60

Padua



Endknopf Padua		Stück
aluminium	850 220 a	37,20
gold matt	850 220 gm	39,60
schwarz matt	850 220 sm	37,20
bronze matt	850 220 bm	39,60



Leichte Farbunterschiede zwischen Stange, Endknöpfen und Wandträger können aus produktionstechnischen Gründen auftreten.

flIX

Ø20

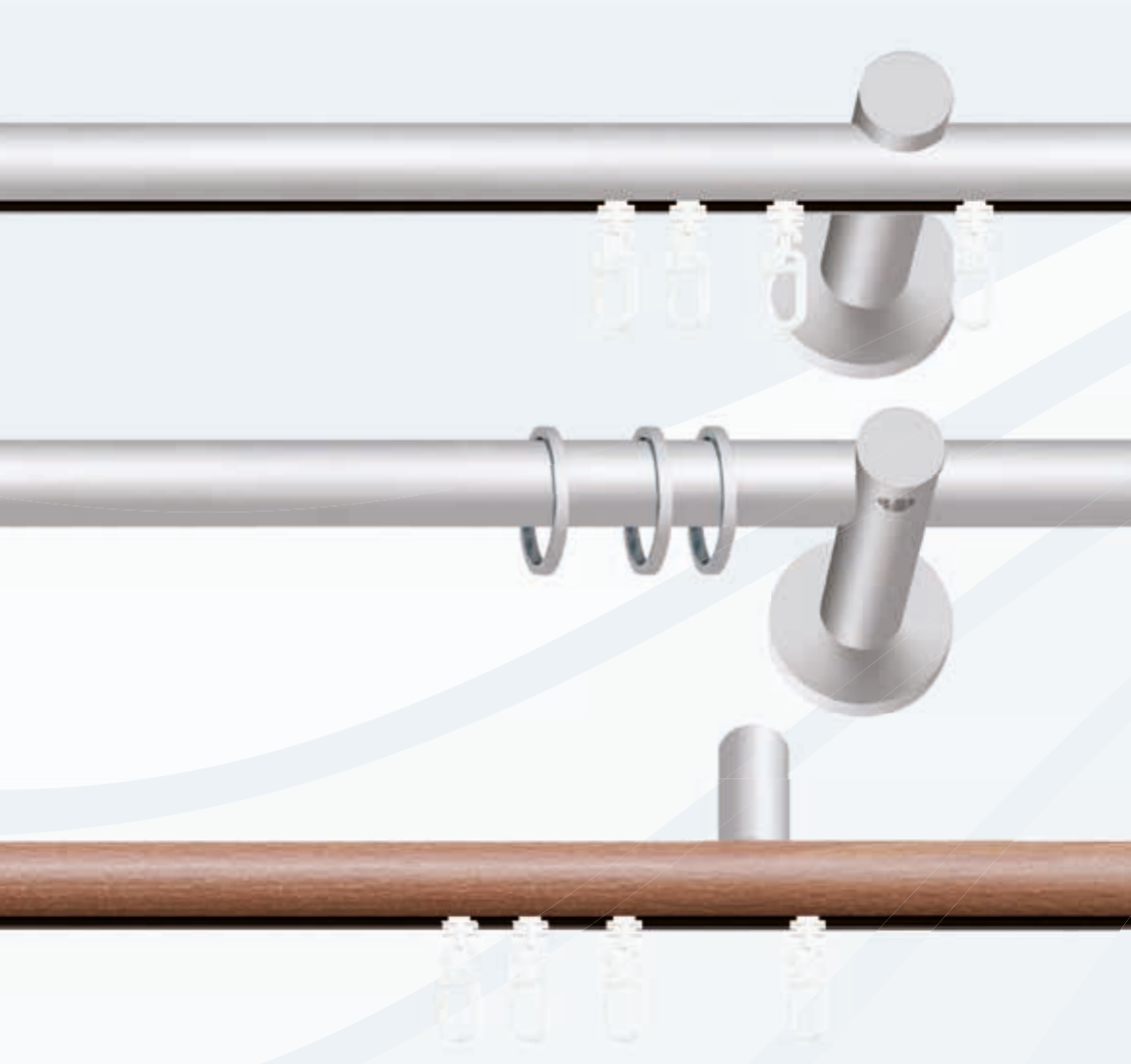

Aluminium Ø20mm Trägersysteme

Aluminium
Ø20

Träger-
systeme

Aluminium Ø20 mm - Trägersysteme



Farben Zubehör



Farben Stangen

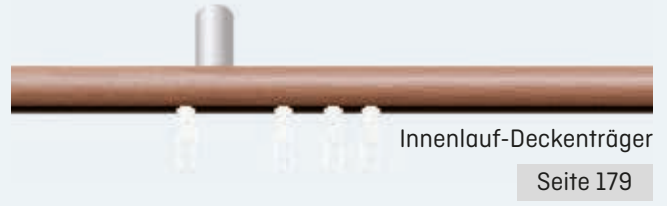

Farben Zubehör



Farben Stangen

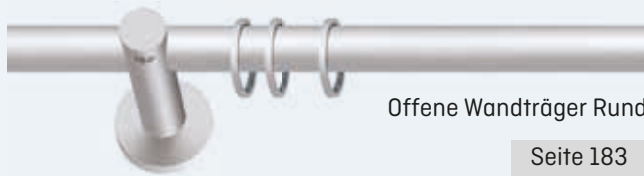

Farben Zubehör & Stangen



Farben Zubehör & Stangen





mit KLIXI
Drehgleiter

Erkerausführung



Farben Zubehör

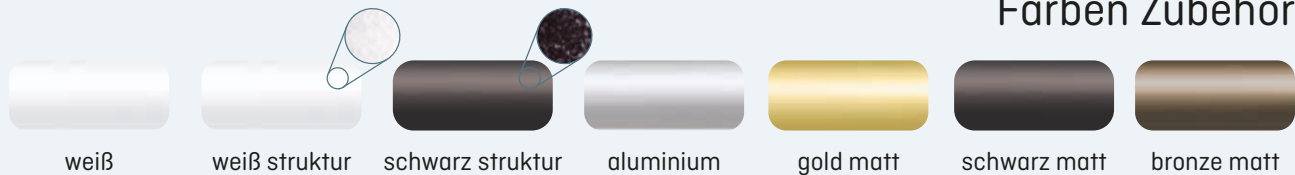

Farben Innenlauf-Profile



* IL-Profile in buche, wildeiche, zwetschke, weiß struktur, schwarz struktur: Laufroller Art. 2420

Innenlauf-Wandträger

Aluminium
Ø20

Träger-
systeme

Garnituren mit Innenlauf-Wandträgern ohne Endknöpfe

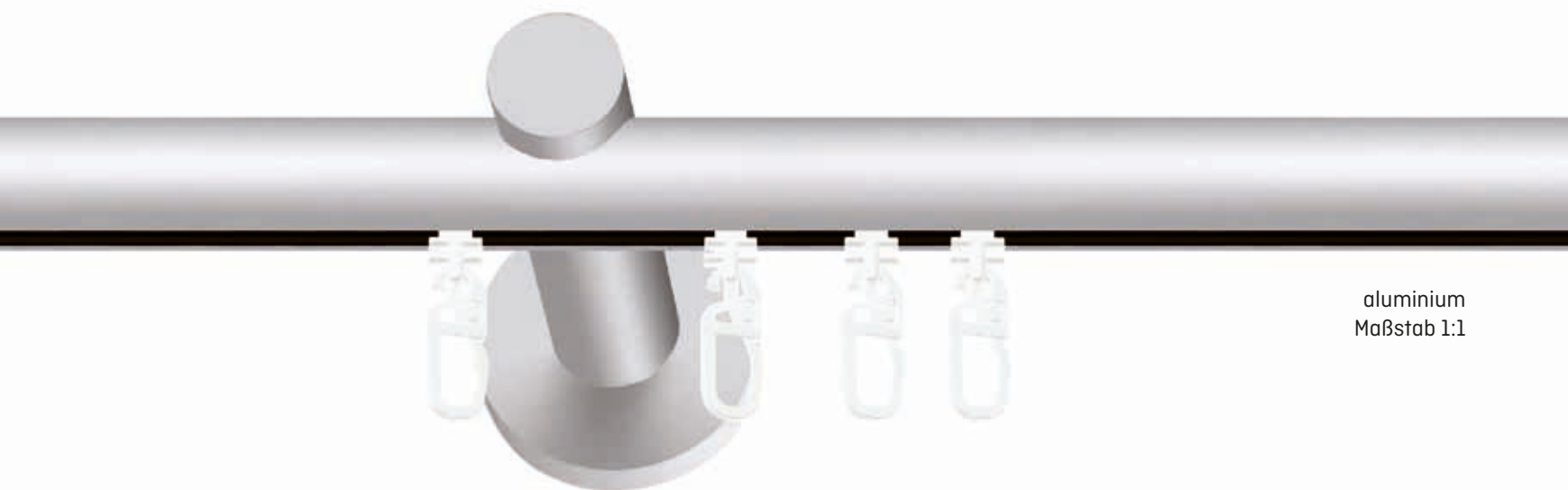

aluminium
Maßstab 1:1





gold matt
Maßstab 1:1







schwarz matt
Maßstab 1:1

Lieferumfang

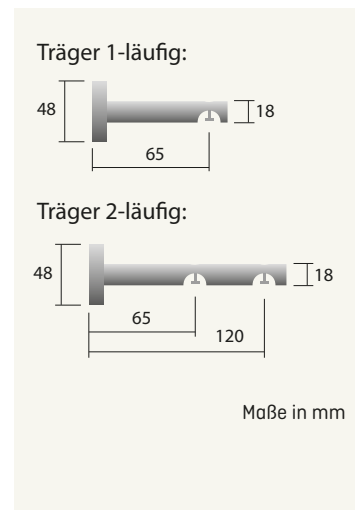
- ▶ **1 lfg:** 1 Alu Innenlauf-Profil Ø20mm oberflächenbehandelt, je nach Länge Wandträger und -Drehgleiter lt. Liste
 - ▶ **2 lfg:** 2 Alu Innenlauf-Profile Ø20mm oberflächenbehandelt, je nach Länge Wandträger und -Drehgleiter lt. Liste, 2 Endkappen
- ▶ mit Montagematerial
 - ▶ Bestellmaß = Profilmaß
 - ▶ Trägermitte bis Innenlaufprofil-Unterkante: 22mm
 - ▶ bei geänderter Ausführung Aufpreis bzw. Preisänderung
 - ▶ **Aus produktionstechnischen Gründen bestehen geringfügige Farbabweichungen zwischen den Karniesenkomponenten.**
 - ▶ **IL-Profile in buche, wildeiche, zwetschke, weiß struktur, schwarz struktur: nur Laufroller Art. 2420 ohne Aufpreis**

Trägermaße







		aluminium		gold matt		schwarz matt		bronze matt		weiß		weiß struktur		schwarz struk.		Preisänderung für IL-Profil in:	
Bestellcode:		t20-101	t20-102	t20-103	t20-104	t20-105	t20-106	t20-107	t20-108	t20-109	t20-110	t20-111	t20-112	t20-113	t20-114	 buche  wildeiche  zwetschke	
Länge (cm)	Wandträger Gleiter 1l./2l.	1lfg	2lfg	1lfg	2lfg	1lfg	2lfg	1lfg	2lfg	1lfg	2lfg	1lfg	2lfg	1lfg	2lfg	1lfg	2lfg
100	2 16/32	104	190	117	212	112	202	117	212	112	202	117	216	117	216	3	6
120	2 18/36	111	204	124	227	120	217	124	227	120	217	125	232	125	232	4	8
140	2 22/44	118	218	131	242	128	232	131	242	128	232	133	248	133	248	5	10
160	2 26/52	125	232	138	257	136	247	138	257	136	247	141	264	141	264	6	12
180	2 28/54	132	246	145	272	144	262	145	272	144	262	149	280	149	280	7	14
200	2 32/64	139	260	152	287	152	277	152	287	152	277	157	296	157	296	8	16
220	3 34/68	179	319	201	354	196	342	201	354	196	342	204	365	204	365	9	18
240	3 38/76	186	333	208	369	204	357	208	369	204	357	212	381	212	381	10	20
260	3 42/84	193	347	215	384	212	372	215	384	212	372	220	397	220	397	11	22
280	3 44/88	200	361	222	399	220	387	222	399	220	387	228	413	228	413	12	24
300	3 48/96	207	375	229	414	228	402	229	414	228	402	236	429	236	429	13	26
320	3 50/100	214	389	236	429	236	417	236	429	236	417	244	445	244	445	14	28
340	3 54/108	221	403	243	444	244	432	243	444	244	432	252	461	252	461	15	30
360	3 58/116	228	417	250	459	252	447	250	459	252	447	260	477	260	477	16	32
380	3 60/120	235	431	257	474	260	462	257	474	260	462	268	493	268	493	17	34
400	4 64/128	275	488	308	540	303	528	308	540	303	528	316	564	316	564	18	36
+20 cm ▲	3/6	7	14	7	15	8	15	7	15	8	15	8	16	8	16	1	2
Preisänderung bei Wandlager	1-seitig	+2,20	+12,70	-3,60	+3,60	-1,30	+6,30	-3,60	+4	-1	+6	-1	+7	-1	+7		
	2-seitig	+4,30	+25,40	-7,20	+7,20	-2,50	+12,30	-7,20	+7,20	-3	+12	-3	+13	-3	+13		

▲ ab einer Länge von ca. 580 cm bzw. bei schwereren Vorhängen wird ein weiterer Träger empfohlen (Aufpreis)

Aluminium
Ø20

Träger-
systeme

Träger und passende Verlängerungen			
Wandträger 1lfg - Wandabstand 65mm			
	aluminium	871 052 a	34,80
	gold matt	871 052 gm	39,60
	schwarz matt	871 052 sm	34,80
	bronze matt	871 052 bm	39,60
	weiß	871 052 w	34,80
	weiß struktur	871 052 ws	34,80
	schwarz struktur	871 052 ss	34,80
	Wandträger 2lfg - Wandabstand 65/120mm		
	aluminium	871 142 a	46,80
	gold matt	871 142 gm	51,60
	schwarz matt	871 142 sm	46,80
	bronze matt	871 142 bm	51,60
	weiß	871 142 w	46,80
	weiß struktur	871 142 ws	46,80
	schwarz struktur	871 142 ss	46,80
	Trägerverlängerung 35mm		
	aluminium	871 043 a	15,60
	gold matt	871 043 gm	18,-
	schwarz matt	871 043 sm	15,60
	bronze matt	871 043 bm	18,-
	weiß	871 043 w	15,60
	weiß struktur	871 043 ws	15,60
	schwarz struktur	871 043 ss	15,60

Endkappe Ø20mm			
	aluminium	830 020 a	14,40
	gold matt	830 020 gm	16,80
	schwarz matt	830 020 sm	14,40
	bronze matt	830 020 bm	16,80
	weiß	830 020 w	14,40
	weiß struktur	830 020 ws	14,40
	schwarz struktur	830 020 ss	14,40

Endkappe flächenbündig Anna Ø20mm			
	aluminium	831 420 a	22,80
	gold matt	831 420 gm	25,20
	schwarz matt	831 420 sm	22,80
	bronze matt	831 420 bm	25,20
	chrom glanz	831 420 cg	28,80
	weiß	831 420 s	22,80
	weiß struktur	831 420 ws	22,80
	schwarz struktur	831 420 ss	22,80

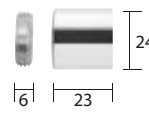
Wandlager Ø20mm			
	aluminium	82 320 a	33,60
	gold matt	82 320 gm	36,-
	schwarz matt	82 320 sm	33,60
	bronze matt	82 320 bm	36,-
	weiß	82 320 w	33,60
	weiß struktur	82 320 ws	33,60
	schwarz struktur	82 320 ss	33,60

Alu Innenlauf-Profil Ø20mm, Stange 6mm			
	aluminium	n90 620 a	38,60
	gold matt	n90 620 gm	38,60
	schwarz matt	n90 620 sm	38,60
	bronze matt	n90 620 bm	38,60
	buche	n90 620 bu	41,40
	wildeiche	n90 620 wi	41,40
	zwetschke	n90 620 zw	41,40
	weiß	n90 620 w	38,60
	weiß struktur	n90 620 ws	38,60
	schwarz struktur	n90 620 ss	38,60

Profilverbinder Messing			
	vernickelt	904 071	12,-

Profilverbinder Messing, beliebiger Winkel			
	vernickelt	904 072 - bw	28,80

Gehungsschnitt (ohne Profilverbinder)			
	90°	1bg-1gs-90	20,-
	beliebiger Winkel	1bg-1gs-bw	49,-

KLIXI-Drehgleiter 100 Stück			
	Kunststoff grau	2400 100 g	12,-
	Kunststoff weiß	2400 100 w	12,-

Gleiter 100 Stück			
	Kunststoff weiß	3942 100	5,40

Ösengleiter 100 Stück			
	Kunststoff weiß	3910 100	9,90

Gardinen-Einfachhaken 100 Stück			
	Kunststoff weiß	601 100	6,50

Gardinen-Doppelhaken 100 Stück			
	Kunststoff weiß	605 100	11,-

Roller mit Faltenleghaken			
	Kunststoff weiß	2420	0,20

 Biegungen siehe Gruppe 10

KLIXI® mit KLIXI Drehgleiter

Erkerausführung



Biegung



Gehrung



Gelenk

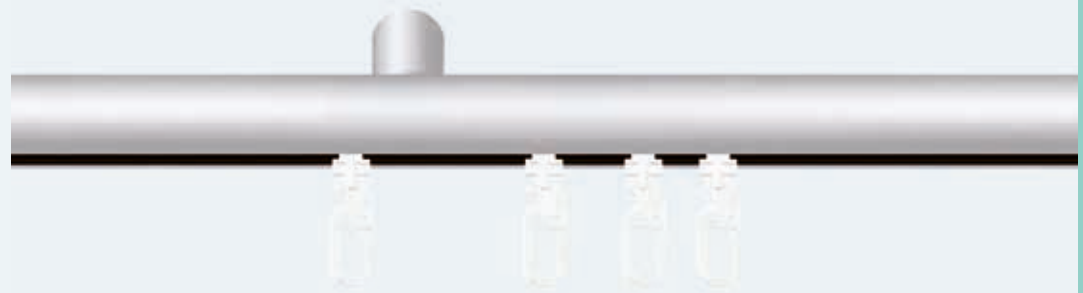

Farben Zubehör

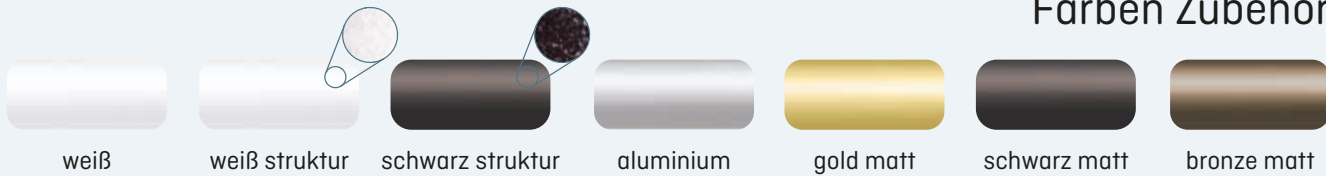

Farben Innenlauf-Profile



* IL-Profile in buche, wildeiche, zwetschke, weiß struktur, schwarz struktur: Laufroller Art. 2420

Innenlauf-Deckenträger

Aluminium
Ø20

Träger-
systeme

Garnituren mit Innenlauf-Deckenträgern ohne Endknöpfe

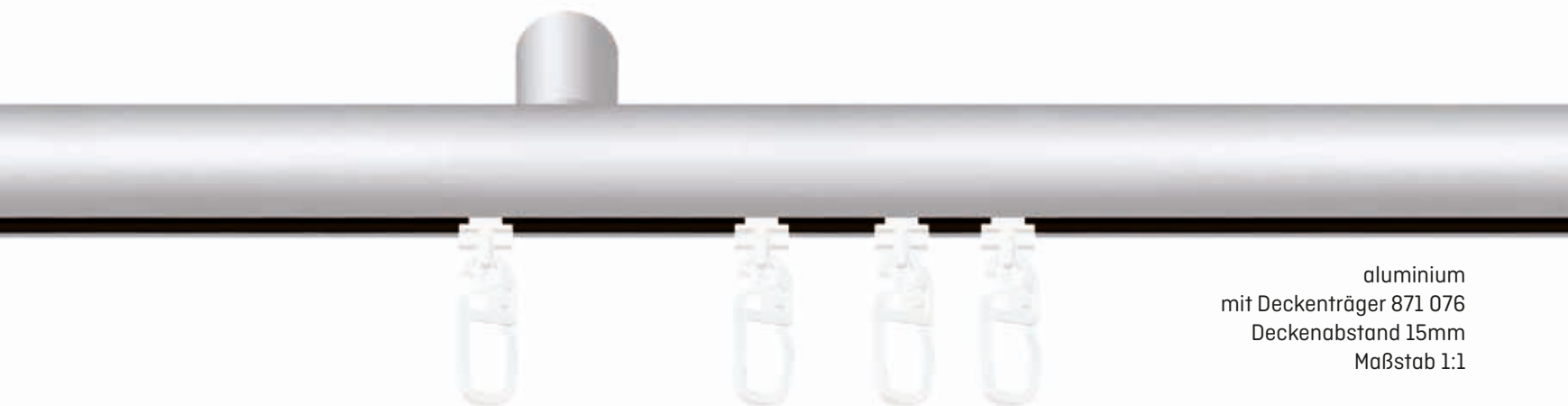

aluminium
mit Deckenträger 871 076
Deckenabstand 15mm
Maßstab 1:1



aluminium/zwetschke
mit Deckenträger 871 077
Deckenabstand 35mm
Maßstab 1:1



schwarz matt
mit Deckenträger 871 053
Deckenabstand 43mm
Maßstab 1:1

Lieferumfang

- ▶ **1 lfg mit Deckenträger 15mm Deckenabstand:**
1 Alu Innenlauf-Profil Ø20mm oberflächenbehandelt, je nach Länge Deckenträger und FLIX-Drehgleiter lt. Liste
 - ▶ **1 lfg mit Deckenträger 35mm Deckenabstand:**
1 Alu Innenlauf-Profil Ø20mm oberflächenbehandelt, je nach Länge Deckenträger und FLIX-Drehgleiter lt. Liste
 - ▶ **1 lfg mit Deckenträger 43mm Deckenabstand:**
1 Alu Innenlauf-Profil Ø20mm oberflächenbehandelt, je nach Länge Deckenträger und FLIX-Drehgleiter lt. Liste
- ▶ mit Montagematerial
 - ▶ Bestellmaß = Profilmaß
 - ▶ Decke bis Innenlauf-Profilunterkante: siehe Maßskizzen rechts
 - ▶ bei geänderter Ausführung Aufpreis bzw. Preisabschlag
 - ▶ **Aus produktionstechnischen Gründen bestehen geringfügige Farbabweichungen zwischen den Karniesenkomponenten.**
 - ▶ **IL-Profile in buche, wildeiche, zwetschke, weiß struktur, schwarz struktur: nur Laufroller Art. 2420 ohne Aufpreis**

Trägermaße

Träger 1-läufig Art. 871 076
Deckenabstand 15mm:

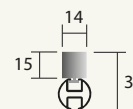

Träger 1-läufig Art. 871 077
Deckenabstand 35mm:

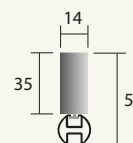

Träger 1-läufig Art. 871 053
Deckenabstand 43mm:

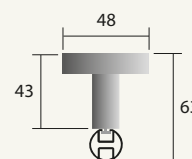



Maße in mm

			weiß			gold matt			weiß struktur						
Bestellcode:			t20-343	t20-344	t20-345	t20-334	t20-335	t20-336	t20-346	t20-347	t20-348				
			schwarz matt			bronze matt			schwarz struktur			aluminium			Preisänderung für IL-Profil in:
Bestellcode:			t20-337	t20-338	t20-339	t20-340	t20-341	t20-342	t20-349	t20-350	t20-351	t20-331	t20-332	t20-333	
Länge (cm)	Wand-träger	Gleiter ll	1lfg	1lfg	1lfg	1lfg	1lfg	1lfg	1lfg	1lfg	1lfg	1lfg	1lfg	1lfg	
100	2	16	84	88	117	86	92	130	88	90	117	82	87	111	3
120	2	18	92	96	125	93	100	138	96	98	125	89	94	118	4
140	2	22	100	104	133	100	108	146	104	106	133	96	101	125	5
160	2	26	108	112	141	107	116	154	112	114	141	103	108	132	6
180	2	28	116	120	149	114	124	162	120	122	149	110	115	139	7
200	2	32	124	128	157	121	132	170	128	130	157	117	122	146	8
220	3	34	154	158	204	154	165	224	161	162	204	146	154	190	9
240	3	38	162	166	212	161	173	232	169	170	212	153	161	197	10
260	3	42	170	174	220	168	181	240	177	178	220	160	168	204	11
280	3	44	178	182	228	175	189	248	185	186	228	167	175	211	12
300	3	48	186	190	236	182	197	256	193	194	236	174	182	218	13
320	3	50	194	198	244	189	205	264	201	202	244	181	189	225	14
340	3	54	202	206	252	196	213	272	209	210	252	188	196	232	15
360	3	58	210	214	260	203	221	280	217	218	260	195	203	239	16
380	3	60	218	222	268	210	229	288	225	226	268	202	210	246	17
400	4	64	247	251	316	246	261	342	258	257	316	231	242	289	18
+ 20cm	▲	3	8	8	8	7	8	8	8	8	8	7	7	7	1

▲ ab einer Länge von ca. 580 cm bzw. bei schwereren Vorhängen wird ein weiterer Träger empfohlen (Aufpreis)

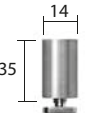
Aluminium
Ø20
Träger-systeme

Träger und passende Verlängerungen			
Deckenträger, Deckenabstand 15mm			
	aluminium	871 076 a	21,60
	gold matt	871 076 gm	24,-
	schwarz matt	871 076 sm	21,60
	bronze matt	871 076 bm	24,-
	weiß	871 076 w	21,60
	weiß struktur	871 076 ws	21,60
	schwarz struktur	871 076 ss	21,60
	Stück		
Deckenträger, Deckenabstand 35mm			
	aluminium	871 077 a	24,-
	gold matt	871 077 gm	26,40
	schwarz matt	871 077 sm	24,-
	bronze matt	871 077 bm	26,40
	weiß	871 077 w	24,-
	weiß struktur	871 077 ws	24,-
	schwarz struktur	871 077 ss	24,-
Stück			
Deckenträger 1lfg., Deckenabstand 43mm/Ø14mm			
	aluminium	871 053 a	34,80
	gold matt	871 053 gm	40,80
	schwarz matt	871 053 sm	34,80
	bronze matt	871 053 bm	40,80
	weiß	871 053 w	34,80
	weiß struktur	871 053 ws	34,80
schwarz struktur	871 053 ss	34,80	
Stück			
Trägerverlängerung 50mm			
	schwarz matt	810 735 sm	16,80
	bronze matt	810 735 bm	19,20
	weiß	810 735 w	16,80
Stück			

Deckenträger kürzbar - Deckenabstand 42-500mm			
	aluminium	871 084 a	57,60
	gold matt	871 084 gm	64,80
	schwarz matt	871 084 sm	57,60
	weiß	871 084 w	57,60
	weiß struktur	871 084 ws	57,60
	schwarz struktur	871 084 ss	57,60
Stück			

Endkappe Ø20mm			
	aluminium	830 020 a	14,40
	gold matt	830 020 gm	16,80
	schwarz matt	830 020 sm	14,40
	bronze matt	830 020 bm	16,80
	weiß	830 020 w	14,40
	weiß struktur	830 020 ws	14,40
	schwarz struktur	830 020 ss	14,40
	Stück		

Endkappe flächenbündig Anna Ø20mm			
	aluminium	831 420 a	22,80
	gold matt	831 420 gm	25,20
	schwarz matt	831 420 sm	22,80
	bronze matt	831 420 bm	25,20
	chrom glanz	831 420 cg	28,80
	weiß	831 420 s	22,80
	weiß struktur	831 420 ws	22,80
	schwarz struktur	831 420 ss	22,80
	Stück		

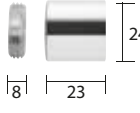
Wandlager Ø20mm			
	aluminium	82 320 a	33,60
	gold matt	82 320 gm	36,-
	schwarz matt	82 320 sm	33,60
	bronze matt	82 320 bm	36,-
	weiß	82 320 w	33,60
	weiß struktur	82 320 ws	33,60
	schwarz struktur	82 320 ss	33,60
	Stück		

Alu Innenlauf-Profilrohr Ø20mm, Stange 6m			
	aluminium	n90 620 a	38,60
	gold matt	n90 620 gm	38,60
	schwarz matt	n90 620 sm	38,60
	bronze matt	n90 620 bm	38,60
	buche	n90 620 bu	41,40
	wildeiche	n90 620 wi	41,40
	zwetschke	n90 620 zw	41,40
	weiß	n90 620 w	38,60
	weiß struktur	n90 620 ws	38,60
	schwarz struktur	n90 620 ss	38,60
	Meter		

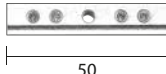
Profilverbinder Messing			
	vernickelt	904 071	12,-
	Stück		

Profilverbinder Messing, beliebiger Winkel			
	vernickelt	904 072 - bw	28,80
	Stück		

Gehungsschnitt (ohne Profilverbinder)			
	90°	1bg-1gs-90	20,-
	beliebiger Winkel	1bg-1gs-bw	49,-
Gehung			

KLIXI-Drehgleiter 100 Stück			
	Kunststoff grau	2400 100 g	12,-
	Kunststoff weiß	2400 100 w	12,-
Beutel			

Gleiter 100 Stück			
	Kunststoff	3942 100	5,40
	Beutel		

Ösengleiter 100 Stück			
	Kunststoff weiß	3910 100	9,90
	Beutel		

Gardinen-Einfachhaken 100 Stück			
	Kunststoff weiß	601 100	6,50
	Beutel		

Gardinen-Doppelhaken 100 Stück			
	Kunststoff weiß	605 100	11,-
	Beutel		

Roller mit Faltenleghaken			
	Kunststoff weiß	2420	0,20
	Stück		

 Biegungen siehe Gruppe 10

Erkerausführung



Biegung



Gehrung



Gelenk

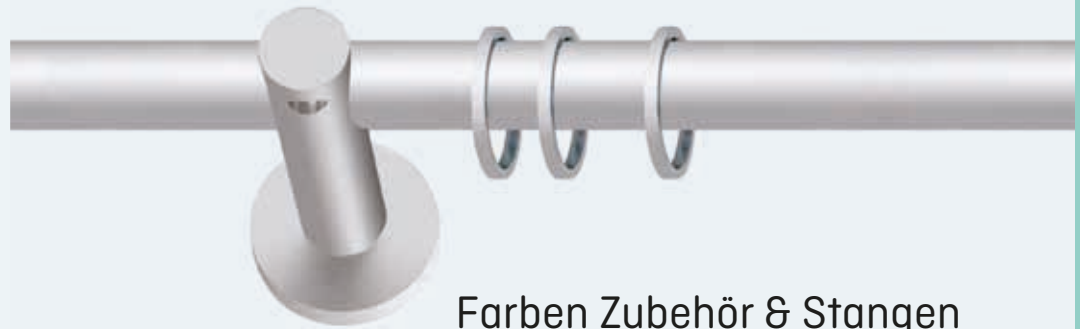

Farben Zubehör & Stangen

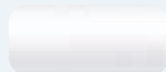

weiß



aluminium



gold matt



schwarz matt



bronze matt

Erkerausführung



Biegung



Gehrung



Gelenk

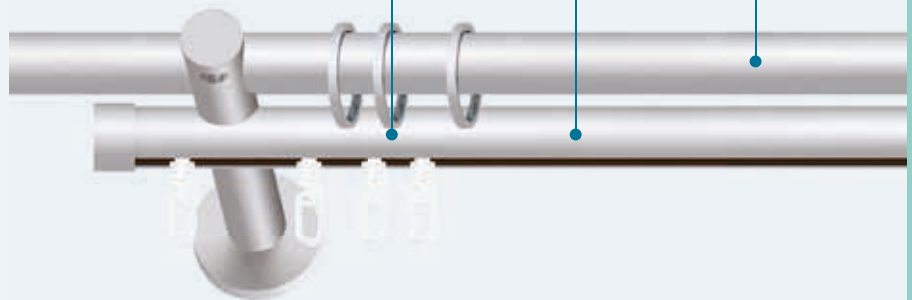

Farben Zubehör & Stangen/Innenlauf-Profile



aluminium



gold matt



schwarz matt



bronze matt

Offene Wandträger Rund

Storeschiene mit Alu-Innenlauf-Profil

Aluminium
Ø20

Träger-
systeme

Garnituren mit Offenen Wandträgern Rund ohne Endknöpfe

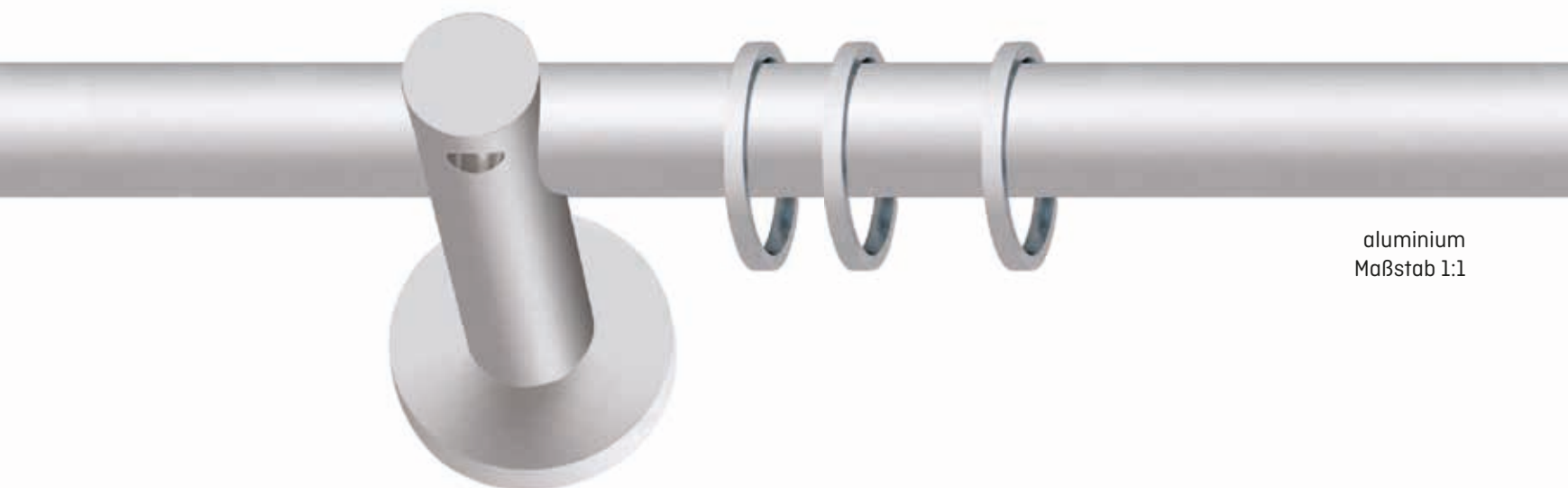

aluminium
Maßstab 1:1

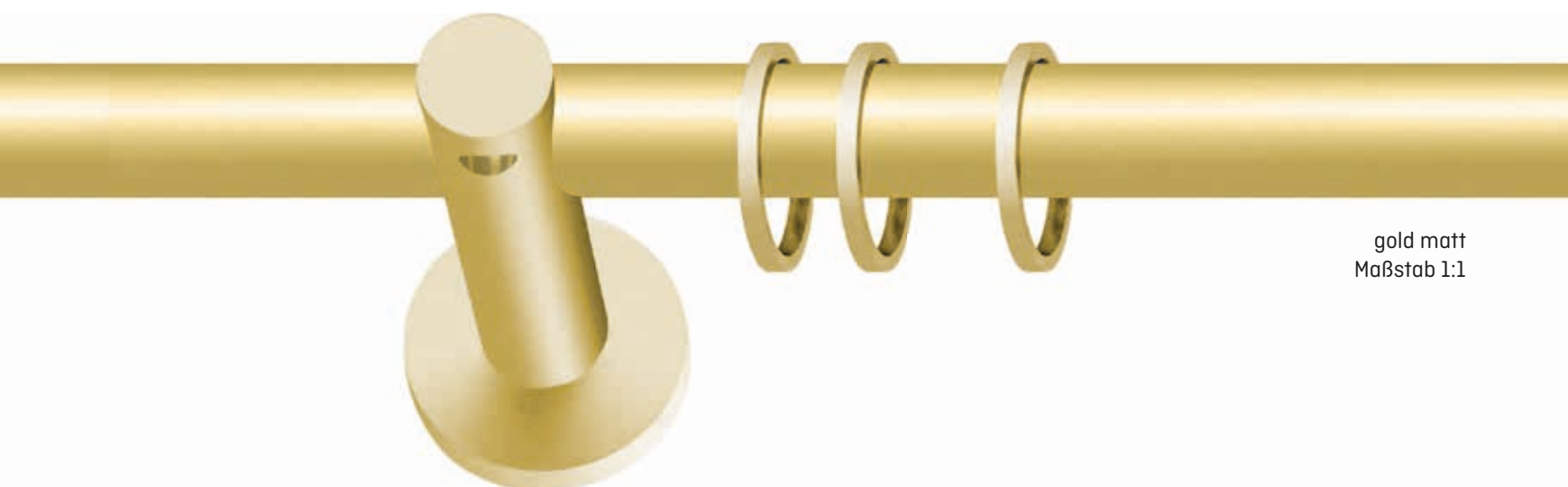

gold matt
Maßstab 1:1

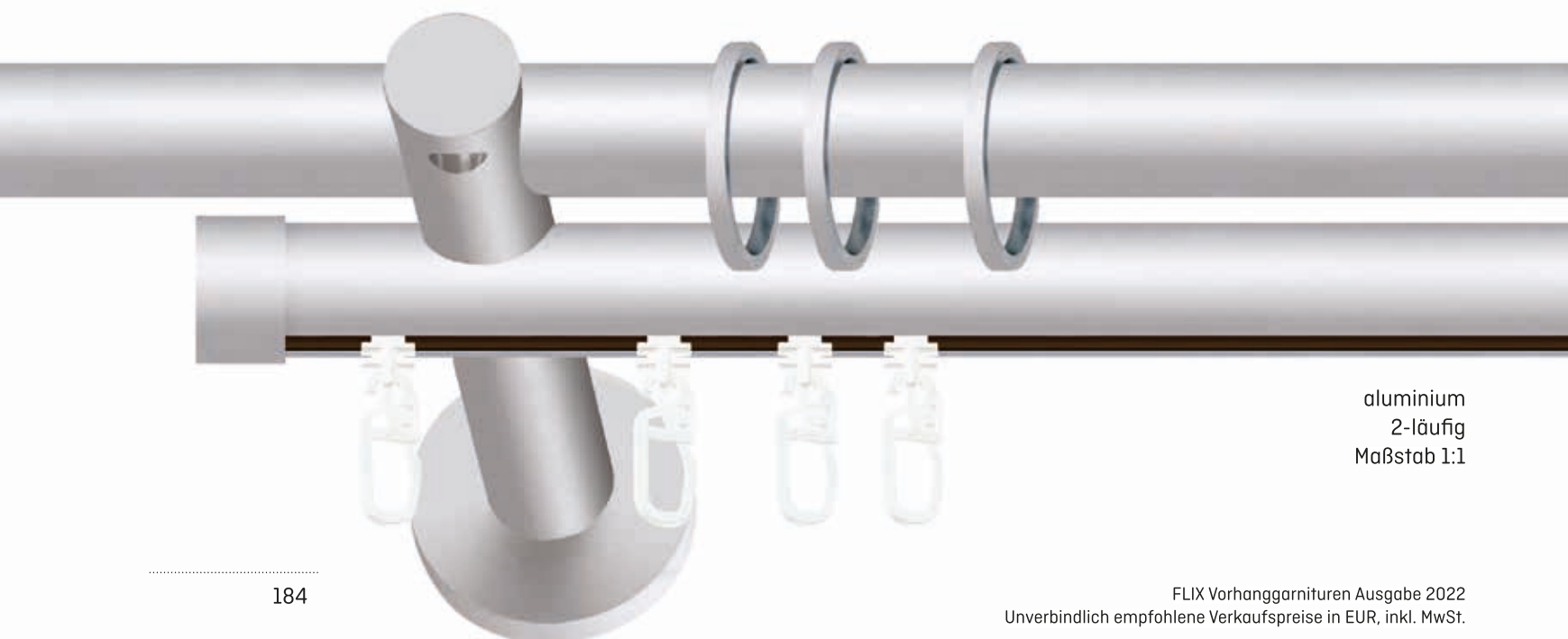

aluminium
2-läufig
Maßstab 1:1





Lieferumfang

- ▶ **1 lfg:** 1 Aluminium-Rohr Ø20mm oberflächenbehandelt, je nach Länge Wandträger und Ringe mit Faltenleghaken lt. Liste
- ▶ **2 lfg:** 2 Aluminium-Rohre Ø20mm oberflächenbehandelt, je nach Länge Wandträger und Ringe mit Faltenleghaken lt. Liste, 2 Endkappen
- ▶ **2 lfg mit Alu Innenlauf-Profil als 2. Lauf:** 1 Aluminium-Rohr Ø20mm oberflächenbehandelt, 1 Alu Innenlauf-Profil Ø20mm oberflächenbehandelt, je nach Länge Wandträger, Ringe mit Faltenleghaken und  -Drehgleiter lt. Liste, 2 Endkappen

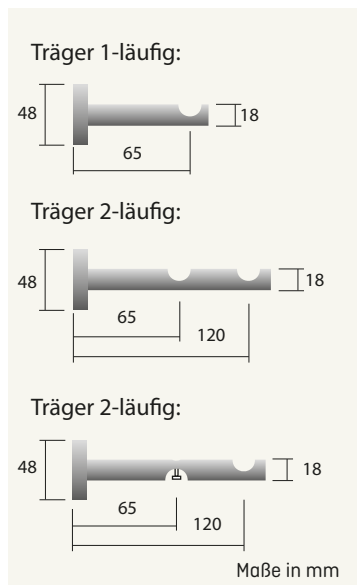
- ▶ mit Montagematerial
- ▶ Bestellmaß = Rohr-/Profilmaß
- ▶ Trägermitte bis Ringunterkante: 18mm
- ▶ Trägermitte bis Innenlaufprofil-Unterkante: 20mm
- ▶ bei geänderter Ausführung Aufpreis bzw. Preisänderung
- ▶ **Aus produktionstechnischen Gründen bestehen geringfügige Farbabweichungen zwischen den Karniesenkomponenten.**

Trägermaße



			 aluminium			 gold matt			 schwarz matt			 bronze matt			 weiß	
Bestellcode:			t20-121	t20-122	t20-197	t20-123	t20-124	t20-198	t20-125	t20-126	t20-199	t20-127	t20-128	t20-200	t20-115	t20-116
Länge (cm)	Wand-träger	Ringe 1l./2l.	1lfg	2lfg	2lfg	1lfg	2lfg	2lfg	1lfg	2lfg	2lfg	1lfg	2lfg	2lfg	1lfg	2lfg
100	2	14/28	121	227	216	138	254	231	128	233	223	138	254	231	126	229
120	2	16/32	132	250	234	150	278	250	140	256	242	150	278	250	137	251
140	2	20/40	143	273	252	162	302	269	152	279	261	162	302	269	148	273
160	2	22/44	154	296	270	174	326	288	164	302	280	174	326	288	159	295
180	2	24/48	165	319	288	186	350	307	176	325	299	186	350	307	170	317
200	2	28/56	176	342	306	198	374	326	188	348	318	198	374	326	181	339
220	3	30/60	220	403	372	246	444	395	230	411	386	246	444	395	226	402
240	3	34/68	231	426	390	258	468	414	242	434	405	258	468	414	237	424
260	3	36/72	242	449	408	270	492	433	254	457	424	270	492	433	248	446
280	3	38/76	253	472	426	282	516	452	266	480	443	282	516	452	259	468
300	3	42/84	264	495	444	294	540	471	278	503	462	294	540	471	270	490
320	3	44/88	275	518	462	306	564	490	290	526	481	306	564	490	281	512
340	3	48/96	286	541	480	318	588	509	302	549	500	318	588	509	292	534
360	3	50/100	297	564	498	330	612	528	314	572	519	330	612	528	303	556
380	3	52/104	308	587	516	342	636	547	326	595	538	342	636	547	314	578
400	4	56/112	356	653	586	395	714	621	371	664	612	395	714	621	363	647
+ 20 cm	▲	3/6	11	23	18	12	24	19	12	23	19	12	24	19	11	22
Preisänderung bei Wandlager	1-seitig		+2	+11,90	+8	-3,50	+3,50	+4	-1,20	+5,90	+6	-3,50	+3,50	+4	-1	+6
	2-seitig		+4	+23,80	+15	-7,10	+7,10	+7	-2,40	+11,80	+12	-7,10	+7,10	+7	-2	+12

▲ ab einer Länge von ca. 580 cm bzw. bei schwereren Vorhängen wird ein weiterer Träger empfohlen (Aufpreis)

Aluminium
Ø20
Träger-systeme

Träger und passende Verlängerungen			
Wandträger 1fg - Wandabstand 65mm			
	aluminium	871 063 a	34,80
	gold matt	871 063 gm	39,60
	schwarz matt	871 063 sm	34,80
	bronze matt	871 063 bm	39,60
	weiß	871 063 w	34,80
Wandträger 2fg - Wandabstand 65/120mm			
	aluminium	871 064 a	46,80
	gold matt	871 064 gm	51,60
	schwarz matt	871 064 sm	46,80
	bronze matt	871 064 bm	51,60
	weiß	871 064 w	46,80
Wandträger 2. Rohr als IL-Rohr - WA 65/120mm			
	aluminium	871 054 a	46,80
	gold matt	871 054 gm	51,60
	schwarz matt	871 054 sm	46,80
	bronze matt	871 054 bm	51,60
Trägerverlängerung 35mm			
	aluminium	871 043 a	15,60
	gold matt	871 043 gm	18,-
	schwarz matt	871 043 sm	15,60
	bronze matt	871 043 bm	18,-
	weiß	871 043 w	15,60

Endkappe Ø20mm			
	aluminium	830 020 a	14,40
	gold matt	830 020 gm	16,80
	schwarz matt	830 020 sm	14,40
	bronze matt	830 020 bm	16,80
	weiß	830 020 w	14,40

Endkappe flächenbündig Anna Ø20mm			
	aluminium	831 420 a	22,80
	gold matt	831 420 gm	25,20
	schwarz matt	831 420 sm	22,80
	bronze matt	831 420 bm	25,20
	weiß	831 420 s	22,80

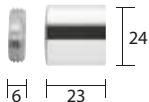
Wandlager Ø20mm			
	aluminium	82 320 a	33,60
	gold matt	82 320 gm	36,-
	schwarz matt	82 320 sm	33,60
	bronze matt	82 320 bm	36,-
	weiß	82 320 w	33,60

Aluminium-Rohr, Ø20mm, Stange 6m			
	aluminium	al 20 a	27,60
	gold matt	al 20 gm	27,60
	schwarz matt	al 20 sm	27,60
	bronze matt	al 20 bm	27,60
	weiß	al 20 w	27,60

Rohrverbinder Ø20mm			
	Metall/Kunststoff	1720	14,40

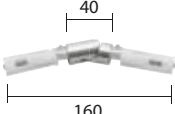
Gelenkverbinder Ø20mm			
	schwarz matt	8920 sm	78,-

Flachring Ø20mm + FH			
	aluminium	847 201 a	2,-
	gold matt	847 201 gm	2,50
	schwarz matt	847 201 sm	2,20
	bronze matt	847 201 bm	2,50

Flachring Ø20mm mit Kunststoffeinfuge + FH			
	aluminium	848 201 a	3,60
	messing matt	848 201 m	3,60
	schwarz matt	848 201 sm	3,60
	bronziert	848 201 b	3,60
	weiß	848 201 w	2,20

Faltenleghaken			
	Kunststoff glasklar	36003 gk	0,10

Alu Innenlauf-Profilrohr Ø20mm, Stange 6m			
	aluminium	n90 620 a	38,60
	gold matt	n90 620 gm	38,60
	schwarz matt	n90 620 sm	38,60
	bronze matt	n90 620 bm	38,60

Profilverbinder Messing			
	vernickelt	904 071	12,-

Profilverbinder Messing, beliebiger Winkel			
	vernickelt	904 072 - bw	28,80

Gehungsschnitt (ohne Profilverbinder)			
	90°	1bg-1gs-90	20,-
	beliebiger Winkel	1bg-1gs-bw	49,-

KLIXI-Drehgleiter 100 Stück			
	Kunststoff grau	2400 100 g	12,-
	Kunststoff weiß	2400 100 w	12,-

Gleiter 100 Stück			
	Kunststoff weiß	3942 100	5,40

Ösengleiter 100 Stück			
	Kunststoff weiß	3910 100	9,90

Gardinen-Einfachhaken 100 Stück			
	Kunststoff weiß	601 100	6,50

Gardinen-Doppelhaken 100 Stück			
	Kunststoff weiß	605 100	11,-

Roller mit Faltenleghaken			
	Kunststoff weiß	2420	0,20

flIX

Ø28



Aluminium Ø28mm

Aluminium
Ø28

Aluminium Ø28 mm - Trägersysteme



Farben Zubehör



Farben Stangen

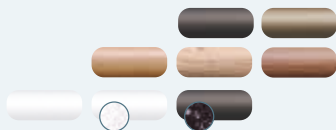

Farben Zubehör



Farben Stangen

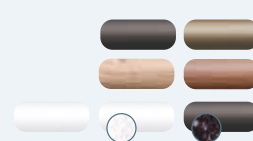

Farben Zubehör & Stangen



Aluminium Ø28 mm - Endknöpfe





Pan
FLÄCHENBÜNDIG

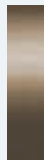
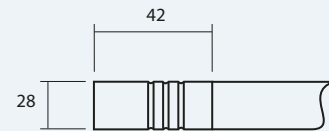

Anna
FLÄCHENBÜNDIG

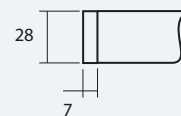

Themis
FLÄCHENBÜNDIG

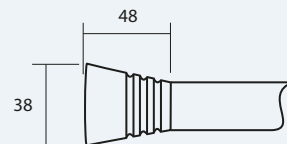

Endknöpfe Aluminium Ø28 mm

Pan

FLÄCHENBÜNDIG

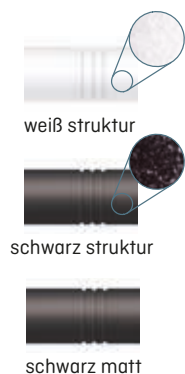

bronze matt
Maßstab 1:1

Endknopf Pan		Stück
schwarz matt	850 929 sm	51,60
bronze matt	850 929 bm	54,-
weiß struktur	850 929 ws	56,70
schwarz struktur	850 929 ss	56,70

Anna

FLÄCHENBÜNDIG



chrom glanz
Maßstab 1:1

Endknopf Anna		Stück
schwarz matt	831 428 sm	26,40
bronze matt	831 428 bm	28,80
chrom glanz	831 428 v	34,80
weiß	831 428 w	29,-
weiß struktur	831 428 ws	29,-
schwarz struktur	831 428 ss	29,-

Themis

FLÄCHENBÜNDIG

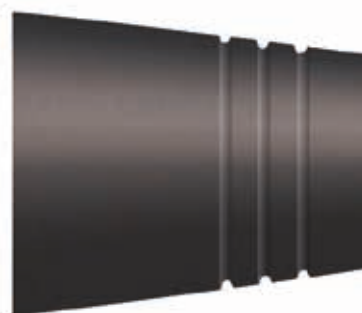

schwarz matt
Maßstab 1:1

Endknopf Themis		Stück
schwarz matt	850 930 sm	51,60
bronze matt	850 930 bm	54,-
weiß struktur	850 930 ws	56,70
schwarz struktur	850 930 ss	56,70

Leichte Farbunterschiede zwischen Stange, Endknöpfen und Wandträger können aus produktionstechnischen Gründen auftreten.

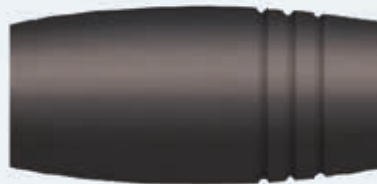

Firenze
FLÄCHENBÜNDIG

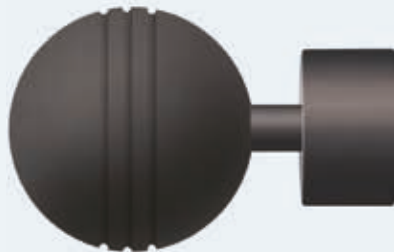
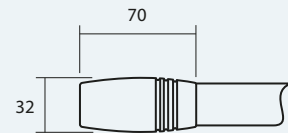

Marsala

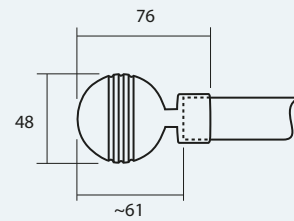

Endknöpfe Aluminium Ø28 mm

Firenze

FLÄCHENBÜNDIG



weiß struktur



schwarz struktur



bronze matt



schwarz matt
Maßstab 1:1

Endknopf Firenze

		Stück
schwarz matt	● 850 931 sm	51,60
bronze matt	● 850 931 bm	54,-
weiß struktur	● 850 931 ws	56,70
schwarz struktur	● 850 931 ss	56,70

Marsala

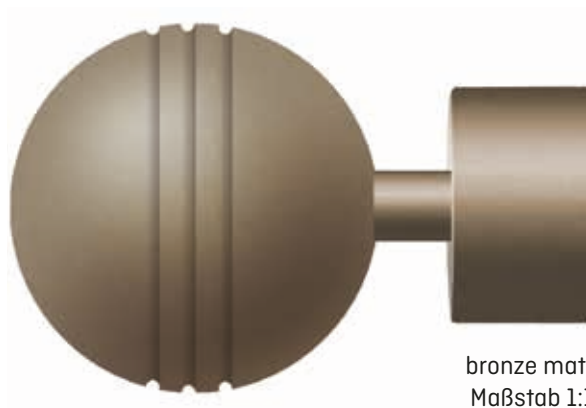

bronze matt
Maßstab 1:1



schwarz matt

Endknopf Marsala

		Stück
schwarz matt	● 850 828 sm	62,40
bronze matt	● 850 828 bm	66,-

Leichte Farbunterschiede zwischen Stange, Endknöpfen und Wandträger können aus produktionstechnischen Gründen auftreten.

flIX

Ø28

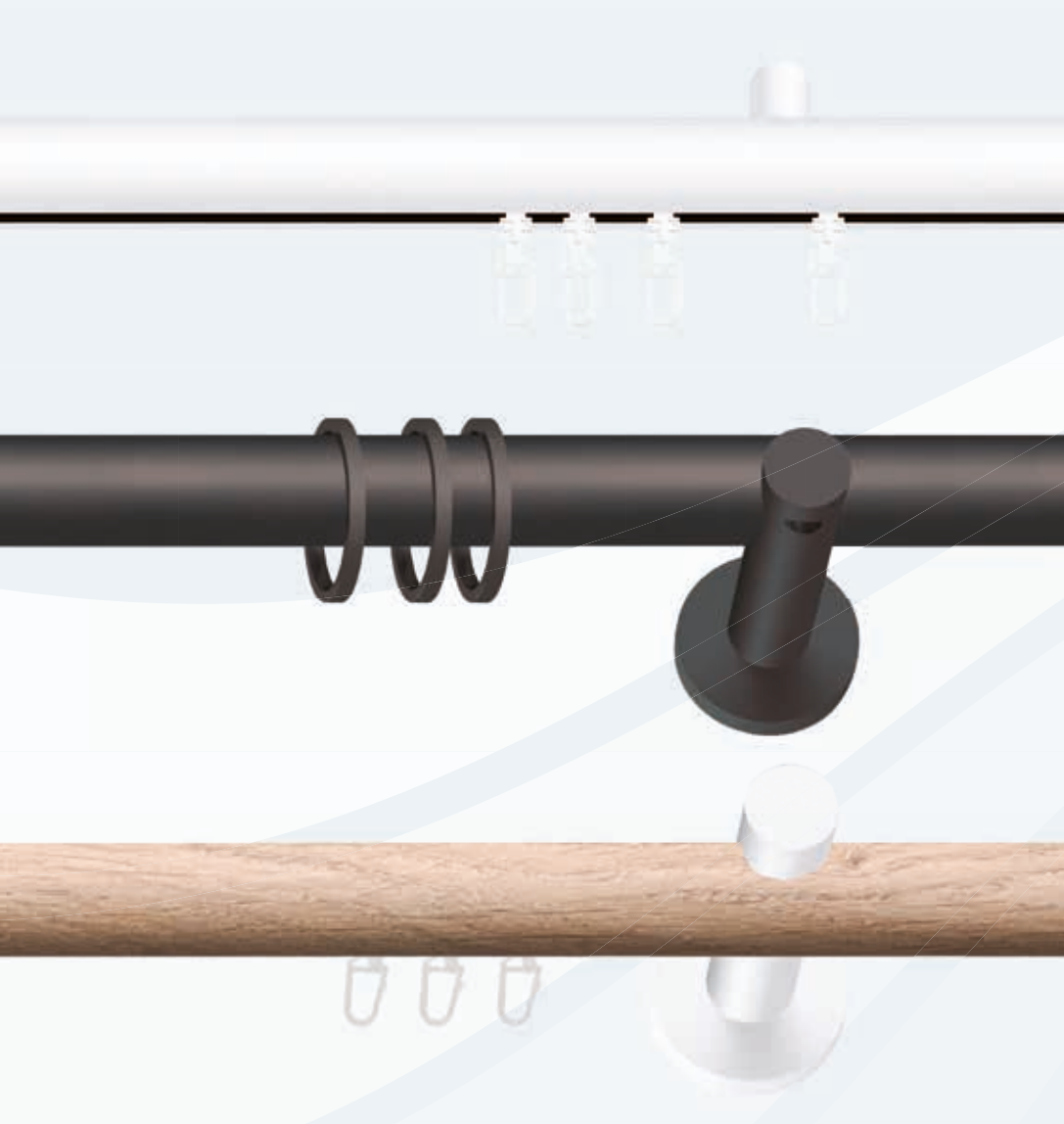

Aluminium Ø28mm Trägersysteme

Aluminium Ø28 mm - Trägersysteme



Farben Zubehör



Farben Stangen

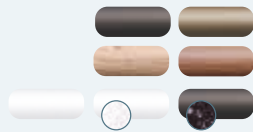

Farben Zubehör



Farben Stangen

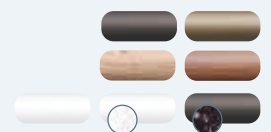

Farben Zubehör & Stangen





mit KLIXI
Drehgleiter

Erkerausführung



Biegung



Gehrung



Gelenk

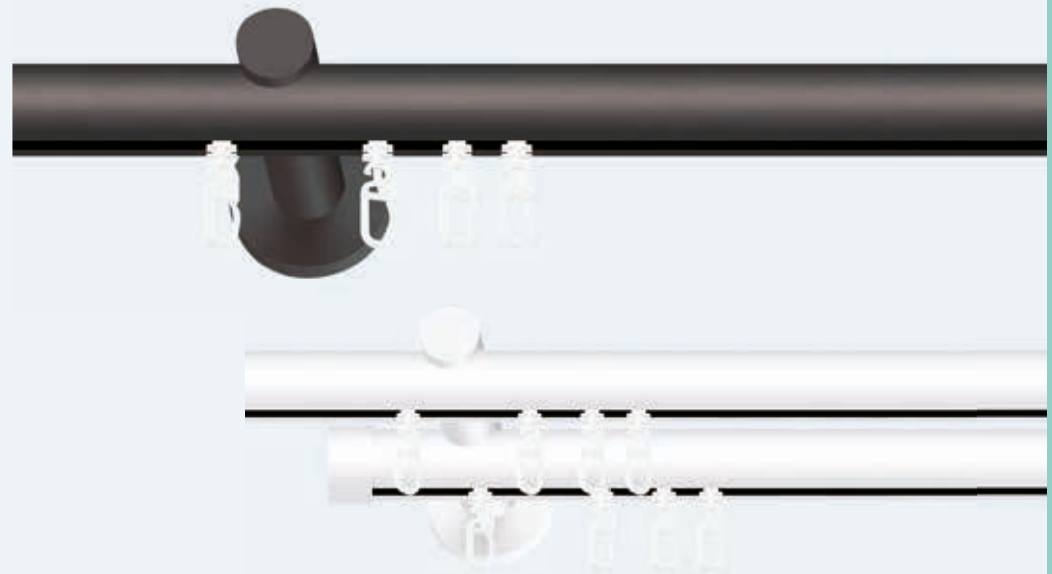

Farben Zubehör

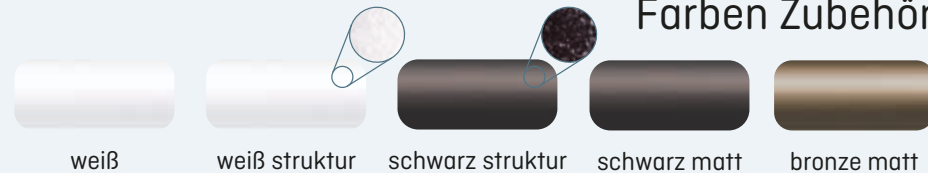

Farben Innenlauf-Profile

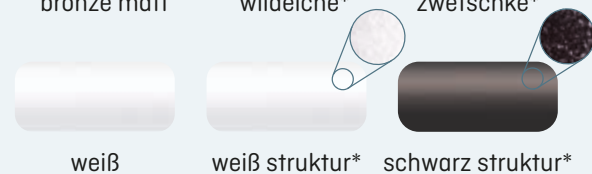
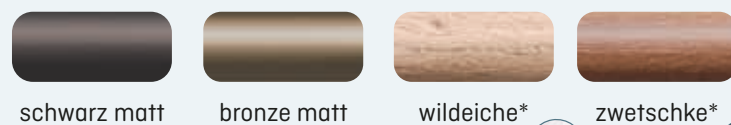

* IL-Profile in wildeiche, zwetschke, weiß struktur, schwarz struktur: Laufroller Art. 2420

Innenlauf-Wandträger

Garnituren mit Innenlauf-Wandträgern ohne Endknöpfe



weiß/wildeiche
Maßstab 1:1





schwarz matt
Maßstab 1:1



weiß
Maßstab 1:1









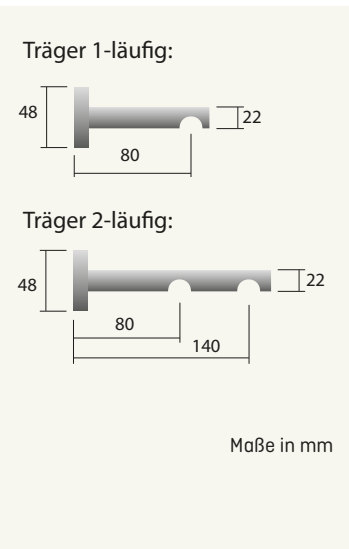





Lieferumfang



- ▶ **1 lfg:** 1 Alu Innenlauf-Profil Ø28mm oberflächenbehandelt, je nach Länge Wandträger und -Drehgleiter lt. Liste
 - ▶ **2 lfg:** 2 Alu Innenlauf-Profile Ø28mm oberflächenbehandelt, je nach Länge Wandträger und -Drehgleiter lt. Liste, 2 Endkappen
- ▶ mit Montagematerial
 - ▶ Bestellmaß = Profilmaß
 - ▶ Trägermitte bis Innenlaufprofil-Unterkante: 35mm
 - ▶ bei geänderter Ausführung Aufpreis bzw. Preisänderung
 - ▶ **Aus produktionstechnischen Gründen bestehen geringfügige Farbabweichungen zwischen den Karniesenkomponenten.**
 - ▶ **IL-Profile in wildeiche, zwetschke, weiß struktur, schwarz struktur: nur Laufroller Art. 2420 ohne Aufpreis**



Trägermaße

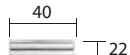

			schwarz matt		bronze matt		weiß		weiß struktur		schwarz struktur		Preisänderung für IL-Profil in:	
Bestellcode:			t28-105	t28-106	t28-107	t28-108	t28-109	t28-110	t28-111	t28-112	t28-113	t28-114	 wildeiche  zwetschke	
Länge (cm)	Wand-träger	Gleiter 1l./2l.	1lfg 	2lfg 	1lfg 	2lfg 	1lfg 	2lfg 	1lfg 	2lfg 	1lfg 	2lfg 	1lfg 	2lfg 
100	2	16/32	132	238	140	253	132	238	132	238	132	238	3	6
120	2	18/36	142	258	150	273	142	258	142	258	142	258	4	8
140	2	22/44	152	278	160	293	152	278	152	278	152	278	5	10
160	2	26/52	162	298	170	313	162	298	162	298	162	298	6	12
180	2	28/54	172	318	180	333	172	318	172	318	172	318	7	14
200	2	32/64	182	338	190	353	182	338	182	338	182	338	8	16
220	2	34/68	192	358	200	373	192	358	192	358	192	358	9	18
240	3	38/76	244	430	255	450	244	430	244	430	244	430	10	20
260	3	42/84	254	450	265	470	254	450	254	450	254	450	11	22
280	3	44/88	264	470	275	490	264	470	264	470	264	470	12	24
300	3	48/96	274	490	285	510	274	490	274	490	274	490	13	26
320	3	50/100	284	510	295	530	284	510	284	510	284	510	14	28
340	3	54/108	294	530	305	550	294	530	294	530	294	530	15	30
360	3	58/116	304	550	315	570	304	550	304	550	304	550	16	32
380	3	60/120	314	570	325	590	314	570	314	570	314	570	17	34
400	3	64/128	324	590	335	610	324	590	324	590	324	590	18	36
+ 20 cm ▲		3/6	10	20	10	20	10	20	10	20	10	20	1	2
Preisänderung bei Wandlager	1-seitig		-1,20	+10,90	-2,40	+8,40	-1	+11	-1	+11	-1	+11		
	2-seitig		-2,40	+21,70	-4,80	+16,90	-2	+22	-2	+22	-2	+22		

▲ ab einer Länge von ca. 420 cm bzw. bei schwereren Vorhängen wird ein weiterer Träger empfohlen (Aufpreis)

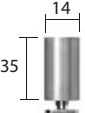
Träger und passende Verlängerungen			
Wandträger 1lfg - Wandabstand 80mm			
			Stück
	schwarz matt	871 058 sm	44,80
	bronze matt	871 058 bm	44,40
	weiß	871 058 w	44,80
	weiß struktur	871 058 ws	44,80
	schwarz struktur	871 058 ss	44,80
Wandträger 2lfg - Wandabstand 80/140mm			
			Stück
	schwarz matt	871 143 sm	55,40
	bronze matt	871 143 bm	55,20
	weiß	871 143 w	55,40
	weiß struktur	871 143 ws	55,40
	schwarz struktur	871 143 ss	55,40
Trägerverlängerung 40mm			
			Stück
	schwarz matt	871 147 sm	19,20
	bronze matt	871 147 bm	20,40
	weiß	871 147 w	19,20
	weiß struktur	871 147 ws	19,20
	schwarz struktur	871 147 ss	19,20

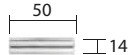
Träger und passende Verlängerungen			
Deckenträger, Deckenabstand 15mm			
			Stück
	schwarz matt	871 076 sm	21,60
	bronze matt	871 076 bm	24,-
	weiß	871 076 w	21,60
	weiß struktur	871 076 ws	21,60
	schwarz struktur	871 076 ss	21,60
Deckenträger, Deckenabstand 35mm			
			Stück
	schwarz matt	871 077 sm	24,-
	bronze matt	871 077 bm	26,40
	weiß	871 077 w	24,-
	weiß struktur	871 077 ws	24,-
	schwarz struktur	871 077 ss	24,-
Deckenträger 1lfg., Deckenabstand 43mm/Ø14mm			
			Stück
	schwarz matt	871 053 sm	34,80
	bronze matt	871 053 bm	40,80
	weiß	871 053 w	34,80
	weiß struktur	871 053 ws	34,80
	schwarz struktur	871 053 ss	34,80
Trägerverlängerung 50mm			
			Stück
	schwarz matt	810 735 sm	16,80
	bronze matt	810 735 bm	19,20
	weiß	810 735 w	16,80

Deckenträger kürzbar - Deckenabstand 42-500mm			
			Stück
	schwarz matt	871 084 sm	57,60
	weiß	871 084 w	57,60
	weiß struktur	871 084 ws	57,60
	schwarz struktur	871 084 ss	57,60

Endkappe Ø28mm			
			Stück
	schwarz matt	830 028 sm	18,-
	bronze matt	830 028 bm	20,40
	weiß	830 028 w	19,80
	weiß struktur	830 028 ws	19,80
	schwarz struktur	830 028 ss	19,80

Endkappe flächenbündig Anna Ø28mm			
			Stück
	schwarz matt	831 428 sm	26,40
	bronze matt	831 428 bm	28,80
	chrom glanz	831 428 v	34,80
	weiß	831 428 w	29,-
	weiß struktur	831 428 ws	29,-
	schwarz struktur	831 428 ss	29,-

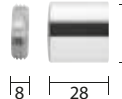
Wandlager Ø28mm			Stück
	schwarz matt	82 328 sm	39,60
	bronze matt	82 328 bm	42,-
	weiß	82 328 w	39,60
	weiß struktur	82 328 ws	39,60
	schwarz struktur	82 328 ss	39,60

Alu Innenlauf-Profil Ø28mm, Stange 6m			Meter
	schwarz matt	n90 628 sm	52,40
	bronze matt	n90 628 bm	52,40
	weiß	n90 628 w	52,40
	weiß struktur	n90 628 ws	52,40
	schwarz struktur	n90 628 ss	52,40
	wildeiche	n90 628 wi	55,20
	zweitschke	n90 628 zw	55,20

Profilverbinder Messing			Stück
	vernickelt	904 071	12,-

Profilverbinder Messing, beliebiger Winkel			Stück
	vernickelt	904 072 - bw	28,80

Gehungsschnitt (ohne Profilverbinder)			Gehrung
	90°	1bg-1gs-90	20,-
	beliebiger Winkel	1bg-1gs-bw	49,-

Gleiter 100 Stück			Beutel
	Kunststoff weiß	3942 100	5,40

KLIXI-Drehgleiter 100 Stück			Beutel
	Kunststoff grau	2400 100 g	12,-
	Kunststoff weiß	2400 100 w	12,-

Ösengleiter 100 Stück			Beutel
	Kunststoff weiß	3910 100	9,90

Gardinen-Einfachhaken 100 Stück			Beutel
	Kunststoff weiß	601 100	6,50

Gardinen-Doppelhaken 100 Stück			Beutel
	Kunststoff weiß	605 100	11,-

Roller mit Faltenleghaken			Stück
	Kunststoff weiß	2420	0,20

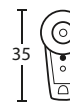
Roller mit Kugellager			Stück
	Kunststoff	904 074	1,10

 Biegunen siehe Gruppe 10

KLIXI® mit KLIXI Drehgleiter

Erkerausführung

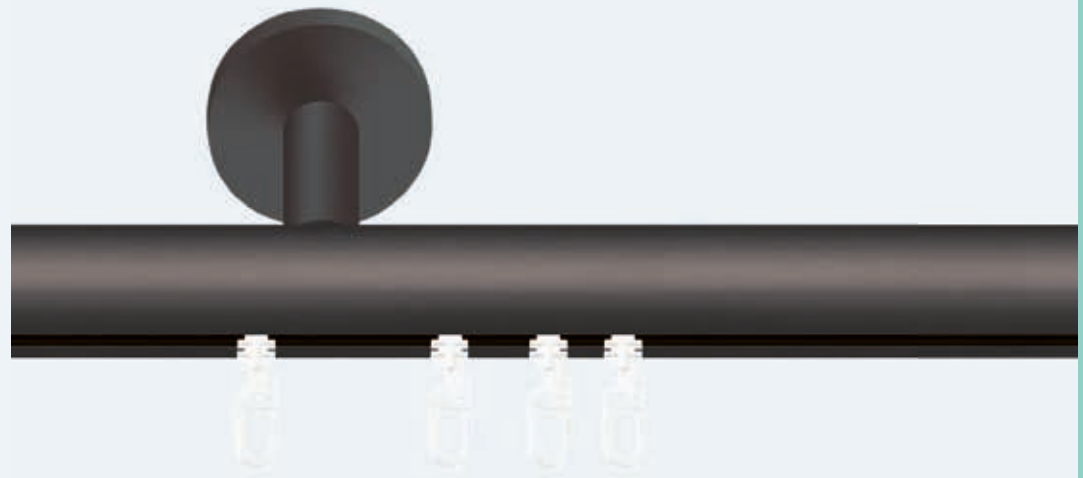

Farben Zubehör

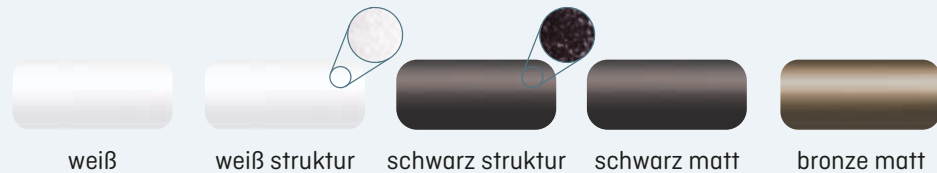

Farben Innenlauf-Profile

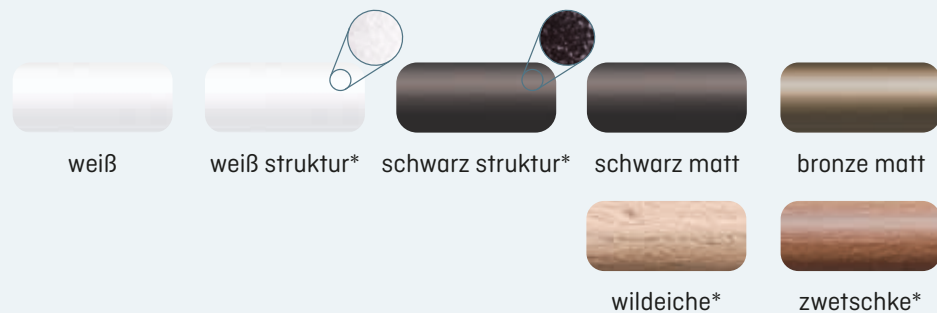

* IL-Profile in wildeiche, zwetschke, weiß struktur, schwarz struktur: Laufroller Art. 2420

Innenlauf-Deckenträger

Garnituren mit Innenlauf-Deckenträgern ohne Endknöpfe

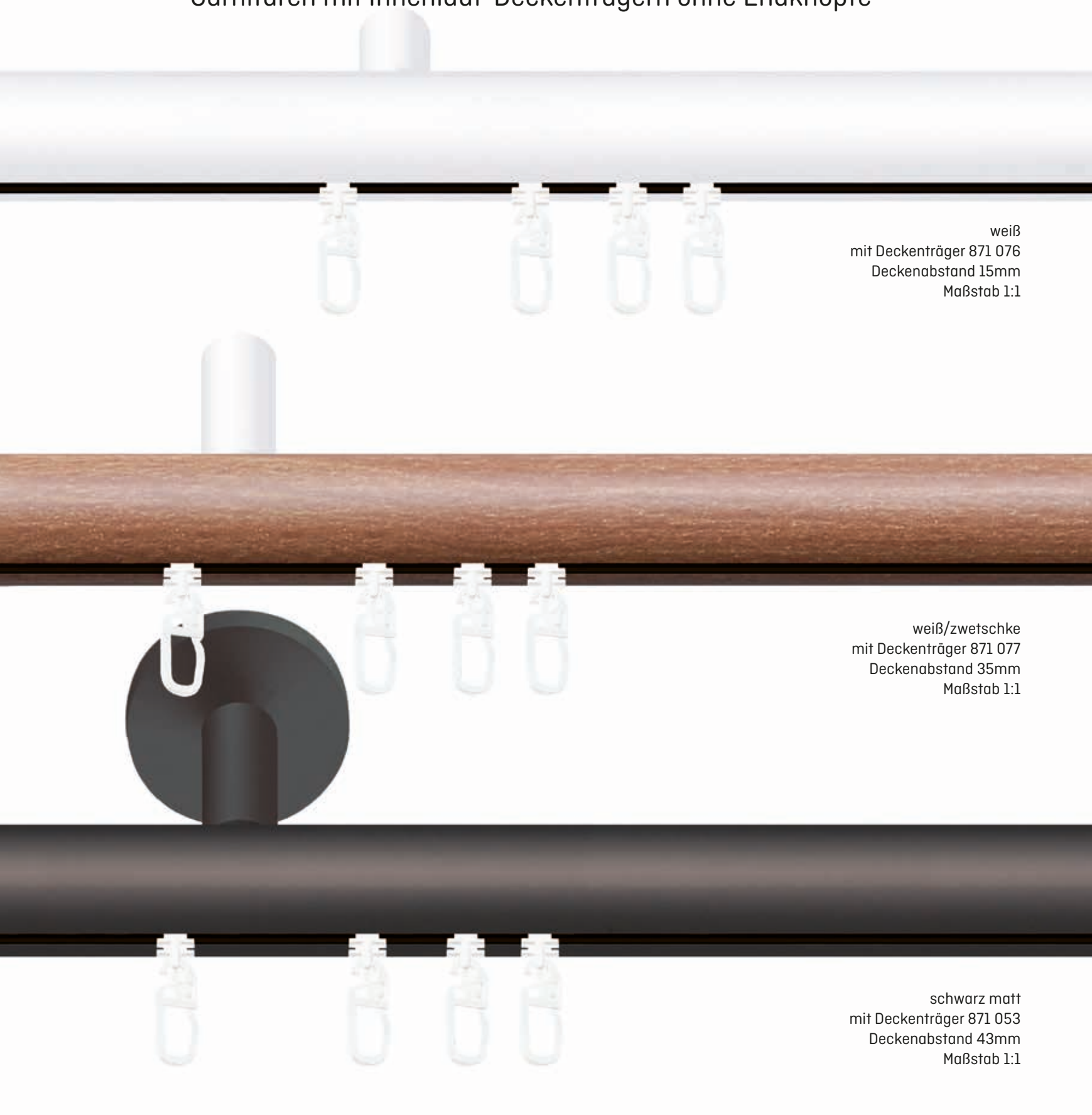

weiß
mit Deckenträger 871 076
Deckenabstand 15mm
Maßstab 1:1

weiß/zwetschke
mit Deckenträger 871 077
Deckenabstand 35mm
Maßstab 1:1

schwarz matt
mit Deckenträger 871 053
Deckenabstand 43mm
Maßstab 1:1

Lieferumfang

- ▶ **1 lfg mit Deckenträger 15mm Deckenabstand:**
1 Alu Innenlauf-Profil Ø28mm oberflächenbehandelt, je nach Länge Deckenträger und -Drehgleiter lt. Liste
 - ▶ **1 lfg mit Deckenträger 35mm Deckenabstand:**
1 Alu Innenlauf-Profil Ø28mm oberflächenbehandelt, je nach Länge Deckenträger und -Drehgleiter lt. Liste
 - ▶ **1 lfg mit Deckenträger 43mm Deckenabstand:**
1 Alu Innenlauf-Profil Ø28mm oberflächenbehandelt, je nach Länge Deckenträger und -Drehgleiter lt. Liste
- ▶ mit Montagematerial
 - ▶ Bestellmaß = Profilmaß
 - ▶ Decke bis Innenlauf-Profilunterkante: siehe Maßskizzen rechts
 - ▶ bei geänderter Ausführung Aufpreis bzw. Preisabschlag
 - ▶ **Aus produktionstechnischen Gründen bestehen geringfügige Farbabweichungen zwischen den Karniesenkomponenten.**
 - ▶ **IL-Profile in wildeiche, zwetschke, weiß struktur, schwarz struktur: nur Laufroller Art. 2420 ohne Aufpreis**

Trägermaße

Träger 1-läufig Art. 871 076
Deckenabstand 15mm:

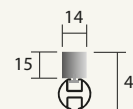

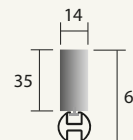

Träger 1-läufig Art. 871 077
Deckenabstand 35mm:



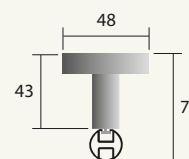

Träger 1-läufig Art. 871 053
Deckenabstand 43mm:



Maße in mm

		weiß			weiß struktur			schwarz matt			schwarz struktur			bronze matt			Preisänderung für IL-Profil in:  wildeiche  zwetschke
Bestellcode:		t28-319	t28-320	t28-321	t28-322	t28-323	t28-324	t28-325	t28-326	t28-327	t28-328	t28-329	t28-330	t28-331	t28-332	t28-333	
Länge (cm)	Wand-träger	Gleiter 1l	1lfg	1lfg	1lfg	1lfg	1lfg	1lfg	1lfg	1lfg	1lfg	1lfg	1lfg	1lfg	1lfg	1lfg	
100	2	16	94	99	120	94	99	120	100	105	134	3					
120	2	18	104	109	130	104	109	130	110	115	144	4					
140	2	22	114	119	140	114	119	140	120	125	154	5					
160	2	26	124	129	150	124	129	150	130	135	164	6					
180	2	28	134	139	160	134	139	160	140	145	174	7					
200	2	32	144	149	170	144	149	170	150	155	184	8					
220	2	34	154	159	180	154	159	180	160	165	194	9					
240	3	38	186	194	226	186	194	226	197	204	248	10					
260	3	42	196	204	236	196	204	236	207	214	258	11					
280	3	44	206	214	246	206	214	246	217	224	268	12					
300	3	48	216	224	256	216	224	256	227	234	278	13					
320	3	50	226	234	266	226	234	266	237	244	288	14					
340	3	54	236	244	276	236	244	276	247	254	298	15					
360	3	58	246	254	286	246	254	286	257	264	308	16					
380	3	60	256	264	296	256	264	296	267	274	318	17					
400	3	64	266	274	306	266	274	306	277	284	328	18					
+ 20cm	▲	3	10	10	10	10	10	10	10	10	10	1					

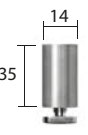
▲ ab einer Länge von ca. 420 cm bzw. bei schwereren Vorhängen wird ein weiterer Träger empfohlen (Aufpreis)

Träger und passende Verlängerungen			
Deckenträger, Deckenabstand 15mm			Stück
	schwarz matt	871 076 sm	21,60
	bronze matt	871 076 bm	24,-
	weiß	871 076 w	21,60
	weiß struktur	871 076 ws	21,60
	schwarz struktur	871 076 ss	21,60
Deckenträger, Deckenabstand 35mm			Stück
	schwarz matt	871 077 sm	24,-
	bronze matt	871 077 bm	26,40
	weiß	871 077 w	24,-
	weiß struktur	871 077 ws	24,-
	schwarz struktur	871 077 ss	24,-
Deckenträger 1lfg., Deckenabstand 43mm/Ø14mm			Stück
	schwarz matt	871 053 sm	34,80
	bronze matt	871 053 bm	40,80
	weiß	871 053 w	34,80
	weiß struktur	871 053 ws	34,80
	schwarz struktur	871 053 ss	34,80
Trägerverlängerung 50mm			Stück
	schwarz matt	810 735 sm	16,80
	bronze matt	810 735 bm	19,20
	weiß	810 735 w	16,80

Deckenträger kürzbar - Deckenabstand 42-500mm			Stück
	schwarz matt	871 084 sm	57,60
	weiß	871 084 w	57,60
	weiß struktur	871 084 ws	57,60
	schwarz struktur	871 084 ss	57,60

Endkappe Ø28mm			Stück
	schwarz matt	830 028 sm	18,-
	bronze matt	830 028 bm	20,40
	weiß	830 028 w	19,80
	weiß struktur	830 028 ws	19,80
	schwarz struktur	830 028 ss	19,80

Endkappe flächenbündig Anna Ø28mm			Stück
	schwarz matt	831 428 sm	26,40
	bronze matt	831 428 bm	28,80
	chrom glanz	831 428 v	34,80
	weiß	831 428 w	29,-
	weiß struktur	831 428 ws	29,-
	schwarz struktur	831 428 ss	29,-

Wandlager Ø28mm			Stück
	schwarz matt	82 328 sm	39,60
	bronze matt	82 328 bm	42,-
	weiß	82 328 w	39,60
	weiß struktur	82 328 ws	39,60
	schwarz struktur	82 328 ss	39,60

Alu Innenlauf-Profil Ø28mm, Stange 6m			Meter
	schwarz matt	n90 628 sm	52,40
	bronze matt	n90 628 bm	52,40
	weiß	n90 628 w	52,40
	weiß struktur	n90 628 ws	52,40
	schwarz struktur	n90 628 ss	52,40
	wildeiche	n90 628 wi	55,20
	zweitschke	n90 628 zw	55,20

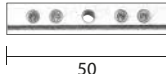
Profilverbinder Messing			Stück
	vernickelt	904 071	12,-

Profilverbinder Messing, beliebiger Winkel			Stück
	vernickelt	904 072 - bw	28,80

Gehungsschnitt (ohne Profilverbinder)			Gehrung
	90°	1bg-1gs-90	20,-
	beliebiger Winkel	1bg-1gs-bw	49,-

Gleiter 100 Stück			Beutel
	Kunststoff weiß	3942 100	5,40

KLIXI-Drehgleiter 100 Stück			Beutel
	Kunststoff grau	2400 100 g	12,-
	Kunststoff weiß	2400 100 w	12,-

Ösengleiter 100 Stück			Beutel
	Kunststoff weiß	3910 100	5,40

Gardinen-Einfachhaken 100 Stück			Beutel
	Kunststoff weiß	601 100	6,50

Gardinen-Doppelhaken 100 Stück			Beutel
	Kunststoff weiß	605 100	11,-

Roller mit Faltenleghaken			Stück
	Kunststoff weiß	2420	0,20

Roller mit Kugellager			Stück
	Kunststoff	904 074	1,10

 Biegungen siehe Gruppe 10

Erker Ausführung



Biegung



Gehrung



Gelenk



Farben Zubehör & Stangen



weiß



schwarz matt



bronze matt

Offene Wandträger Rund

Garnituren mit Offenen Wandträgern Rund ohne Endknöpfe



weiß, mit Ringen
Maßstab 1:1

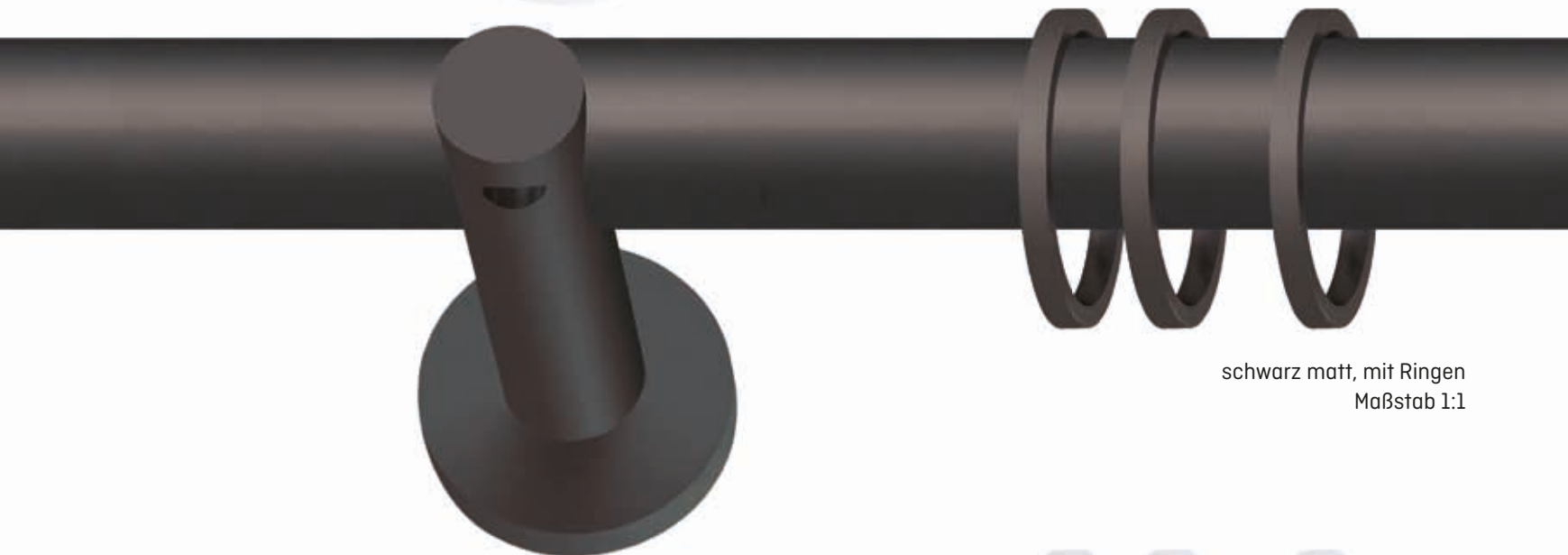

schwarz matt, mit Ringen
Maßstab 1:1



weiß, mit Ringen
Maßstab 1:1

Lieferumfang

- ▶ **1 lfg:** 1 Aluminium-Rohr Ø28mm oberflächenbehandelt, je nach Länge Wandträger und Ringe mit Faltenleghaken lt. Liste
- ▶ **2 lfg:** 2 Aluminiumrohre Ø28mm oberflächenbehandelt, je nach Länge Wandträger, Ringe mit Faltenleghaken lt. Liste, 2 Endkappen

- ▶ mit Montagematerial
- ▶ Bestellmaß = Rohrmaß
- ▶ Trägermitte bis Ringunterkante: 35mm
- ▶ bei geänderter Ausführung Aufpreis bzw. Preisänderung
- ▶ **Aus produktionstechnischen Gründen bestehen geringfügige Farbabweichungen zwischen den Karniesenkomponenten.**

Trägermaße



Träger 1-läufig:



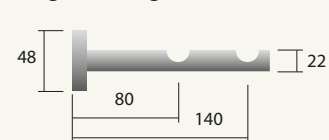

Träger 2-läufig:





Maße in mm

			 weiß	 schwarz matt	 bronze matt			
Bestellcode:			t28-131	t28-132	t28-133	t28-134	t28-129	t28-130
Länge (cm)	Wand-träger	Ringe/Gleiter	1lfg ○	2lfg ○○	1lfg ○	2lfg ○○	1lfg ○	2lfg ○○
100	2	14/16	165	304	165	304	172	318
120	2	16/18	182	338	182	338	189	352
140	2	20/22	199	372	199	372	206	386
160	2	22/26	216	406	216	406	223	420
180	2	24/28	233	440	233	440	240	454
200	2	28/32	250	474	250	474	257	488
220	2	30/34	267	508	267	508	274	522
240	3	34/38	325	593	325	593	335	612
260	3	36/42	342	627	342	627	352	646
280	3	38/44	359	661	359	661	369	680
300	3	42/48	376	695	376	695	386	714
320	3	44/50	393	729	393	729	403	748
340	3	48/54	410	763	410	763	420	782
360	3	50/58	427	797	427	797	437	816
380	3	52/60	444	831	444	831	454	850
400	3	56/64	461	865	461	865	471	884
+ 20cm	▲	3/6	17	34	17	34	17	34
Preisänderung bei Wandlager	1-seitig		-1	+11	-1	+11	-2	+8
	2-seitig		-2	+21	-2	+21	-5	+16

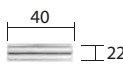
▲ ab einer Länge von ca. 420 cm bzw. bei schwereren Vorhängen wird ein weiterer Träger empfohlen (Aufpreis)

Träger und passende Verlängerungen				
Wandträger 1lfg - Wandabstand 80mm				
		schwarz matt	871 059 sm	44,80
		bronze matt	871 059 bm	44,40
		weiß	871 059 w	44,80
Wandträger 2lfg - Wandabstand 80/140mm				
		schwarz matt	871 146 sm	55,40
		bronze matt	871 146 bm	55,20
		weiß	871 146 w	55,40
Trägerverlängerung 40mm				
		schwarz matt	871 147 sm	19,20
		bronze matt	871 147 bm	20,40
		weiß	871 147 w	19,20

Endkappe Ø28mm				Stück
		schwarz matt	830 028 sm	18,-
		bronze matt	830 028 bm	20,40
		weiß	830 028 w	19,80

Endkappe flächenbündig Anna Ø28mm				Stück
		schwarz matt	831 428 sm	26,40
		bronze matt	831 428 bm	28,80
		weiß	831 428 w	29,-

Wandlager Ø28mm				Stück
		schwarz matt	82 328 sm	39,60
		bronze matt	82 328 bm	42,-
		weiß	82 328 w	39,60

Aluminiumrohr, Ø28mm, Stange 6m				Meter
		schwarz matt	al 28 sm	45,50
		bronze matt	al 28 bm	45,50
		weiß	al 28 w	45,50

Rohrverbinder Ø28mm				Stück
		Metall/Kunststoff	1728	15,60

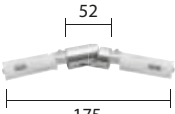
Gelenkverbinder Ø28mm				Stück
		schwarz matt	8928 sm	78,-

Flachring Ø28mm + FH				Stück
		schwarz matt	847 281 sm	3,10
		bronze matt	847 281 bm	3,10
		weiß	847 281 w	3,10

Faltenleghaken				Stück
		Kunststoff glasklar	36003 gk	0,10

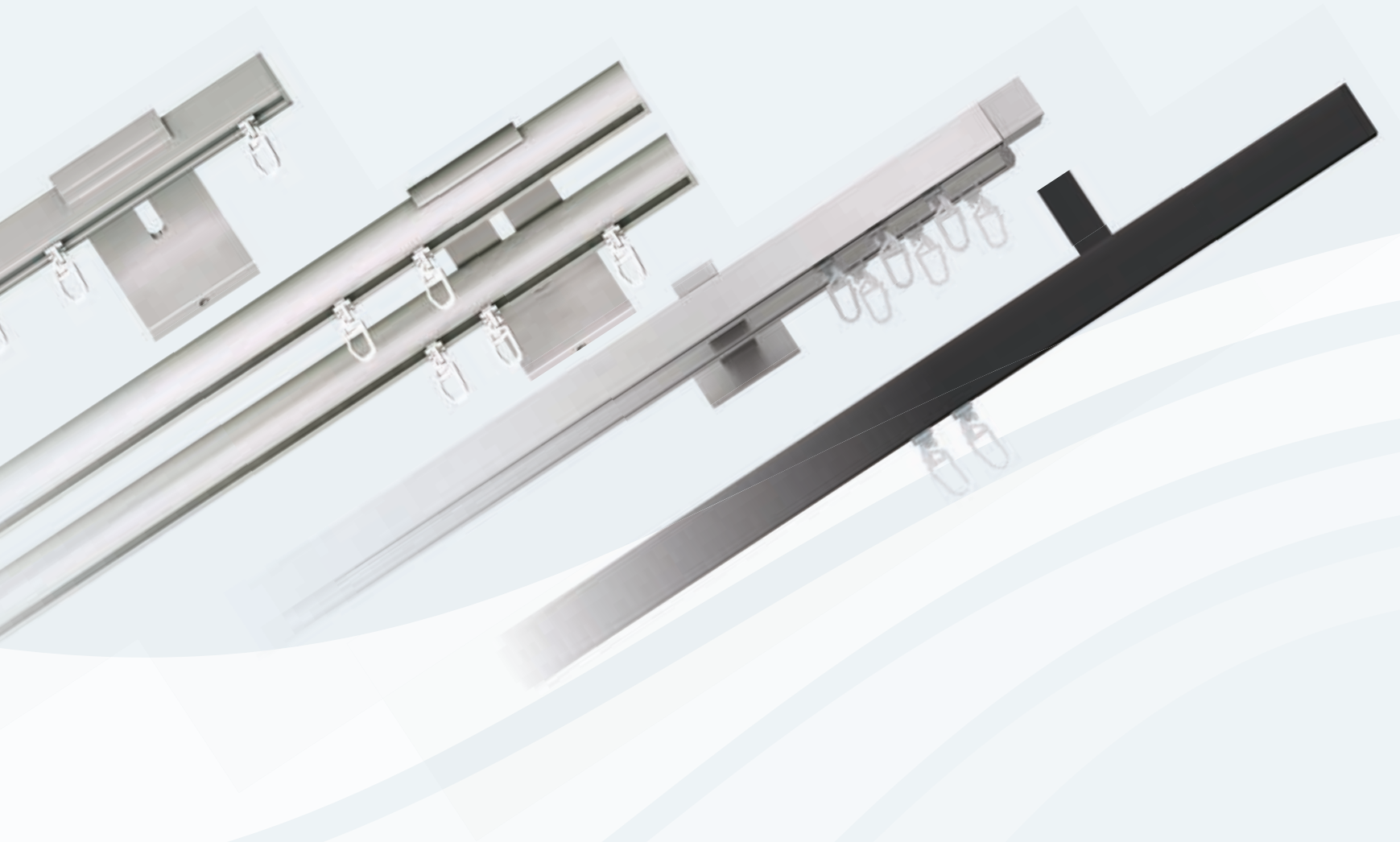

Profil 20-34 mm

Profil 20-34 mm

Übersicht Seite 210

Eckig/Rund 20x20 mm

Komplettgarnituren Seite 211

Quadrat 20x20 mm

Endknöpfe Seite 215

Wandträger Seite 218

Multi-Wandträger Seite 220

Deckenträger Seite 222

Eckig 34x14 mm

Komplettgarnituren Seite 225

Profil 40-70 mm

Übersicht Seite 230

Rechteck 40x15 mm

Endknöpfe Seite 231

Wandträger Seite 233

Multi-Wandträger Seite 236

Deckenträger Seite 238

Oval 40x22 mm

Endknöpfe Seite 243

Wandträger Seite 246

Multi-Wandträger Seite 248

Deckenträger Seite 250

Oval 70x22 mm

Wandträger Seite 254

Multi-Wandträger Seite 256

Deckenträger Seite 258

C-Profil 70x57 mm

Wandträger Seite 263

V-Profil 70x42 mm

Wandträger Seite 267

Blendsystem Flach 60 mm

Multi-Wandträger Seite 272

Deckenträger Seite 274

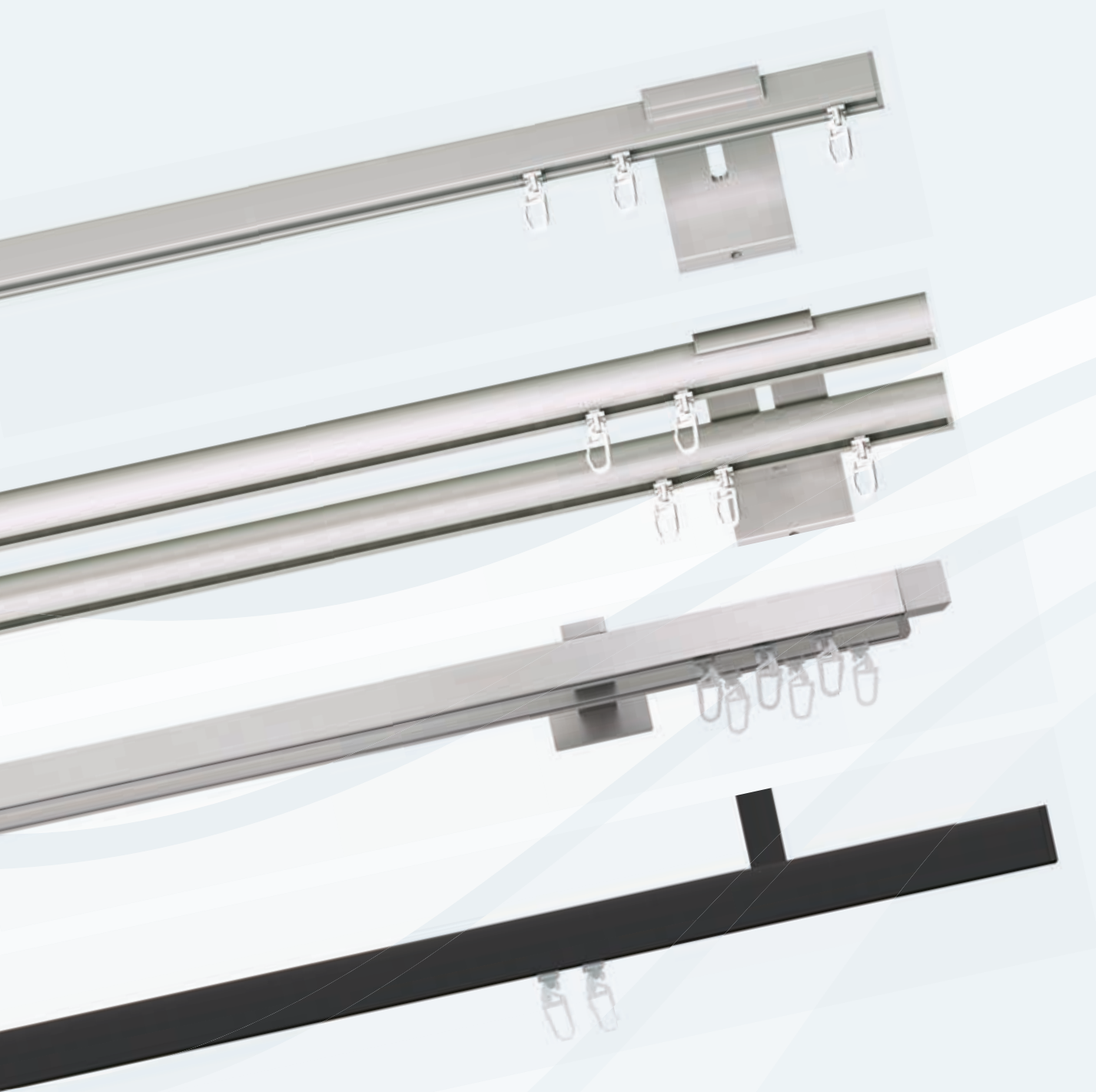

Profilgarnituren 20-34mm

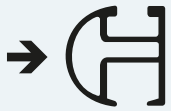

Rund 20x20 mm

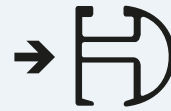

Eckig 20x20 mm



Quadrat 20x20 mm

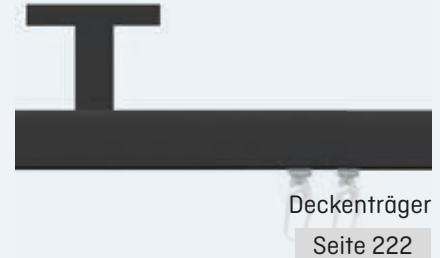

Quadrat 20x20 mm - Endknöpfe



Eckig 34x14 mm



Rund 20x20mm
Eckig 20x20mm

mit KLIXI
Drehgleiter



Farben Zubehör & Stangen



aluminium

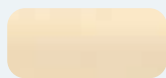

messing matt

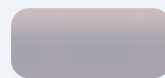

scotch-bright

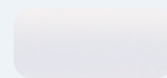

weiß



schwarz

Farbkombinationen möglich, Stange gegenrechnen

Rund 20x20mm / Eckig 20x20mm

Komplettgarnitur ECKIG 20x20mm inkl. Endkappen



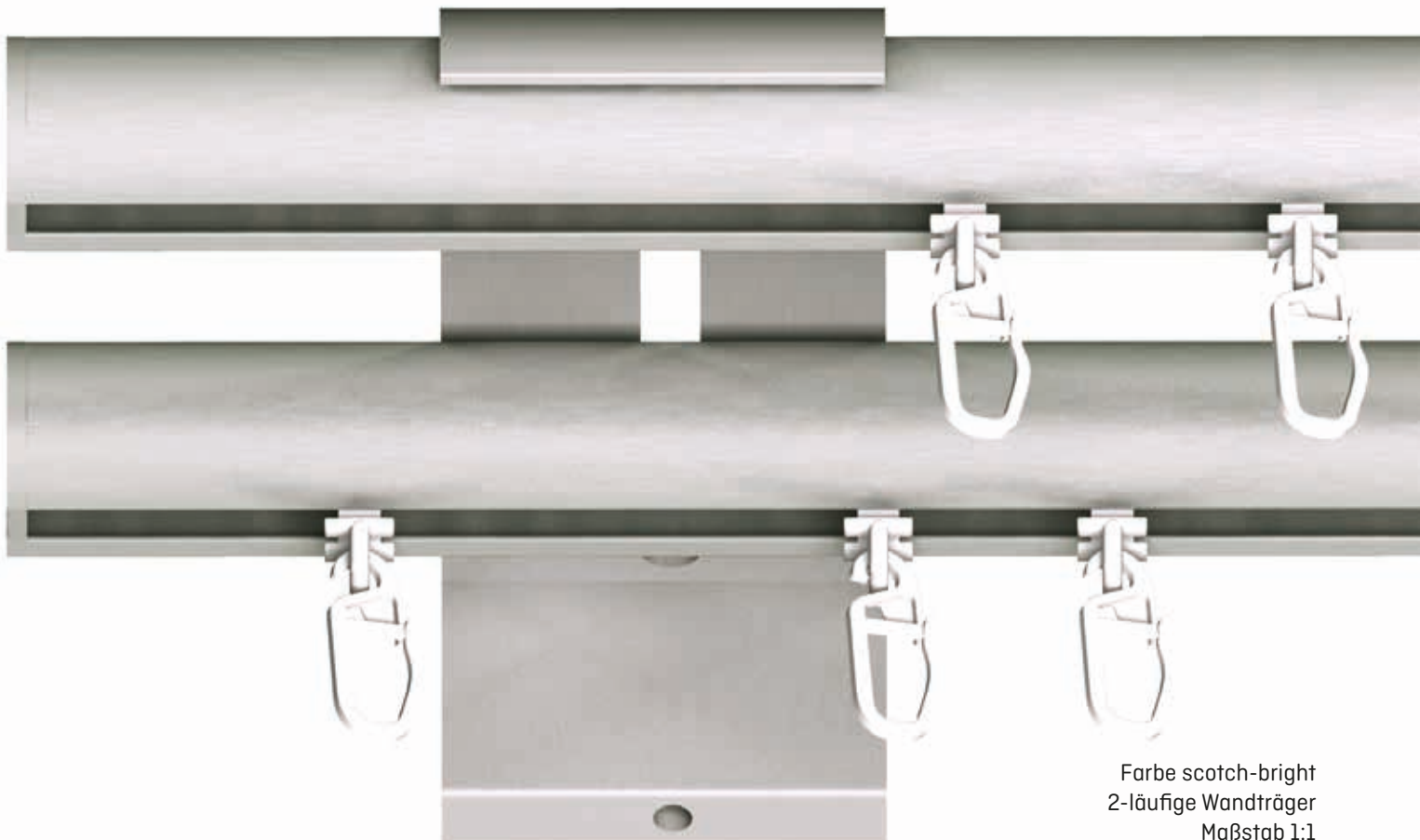

Farbe scotch-bright
1-läufige Wandträger
Maßstab 1:1

Komplettgarnitur RUND 20x20mm inkl. Endkappen











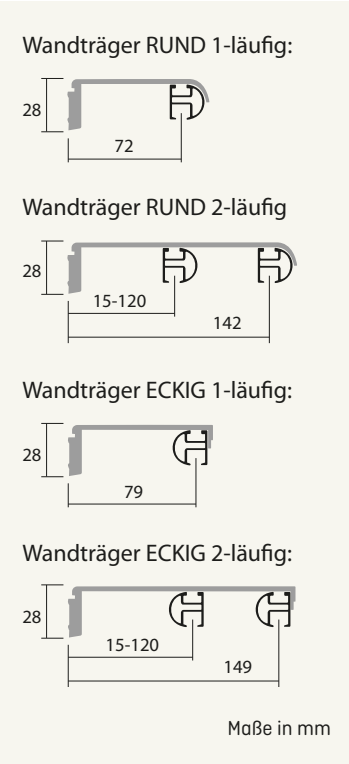



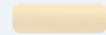
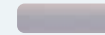
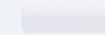











Farbe scotch-bright
2-läufige Wandträger
Maßstab 1:1

Lieferumfang

- ▶ **1 lfg:** 1 Alu Innenlauf-Profil 20,5 x 20,5 mm oberflächenbehandelt, je nach Länge Wandträger RUND oder ECKIG und -Drehgleiter lt. Liste, 2 Endkappen
 - ▶ **2 lfg:** 2 Alu Innenlauf-Profile 20,5 x 20,5 mm oberflächenbehandelt, je nach Länge Wandträger RUND oder ECKIG und -Drehgleiter lt. Liste, 4 Endkappen
- ▶ mit Montagematerial
 - ▶ Bestellmaß = Profilmaß
 - ▶ Trägeroberkante bis Innenlauf-Profilunterkante: -23mm
 - ▶ bei geänderter Ausführung Aufpreis bzw. Preisabschlag
 - ▶ **Aus produktionstechnischen Gründen bestehen geringfügige Farbabweichungen zwischen den Karniesenkomponenten.**

Trägermaße



												
			aluminium		messaging matt		scotch-bright		weiß		schwarz	
			→ 	→ 	→ 	→ 	→ 	→ 	→ 	→ 	→ 	→ 
			t20-084	t20-085	t20-086	t20-087	t20-080	t20-081	t20-082	t20-083	t20-076	t20-077
			→ 	→ 	→ 	→ 	→ 	→ 	→ 	→ 	→ 	→ 
			t20-094	t20-095	t20-096	t20-097	t20-090	t20-091	t20-092	t20-093	t20-078	t20-079
Länge (cm)	Wand-träger	Gleiter 1l./2l.	1lfg	2lfg	1lfg	2lfg	1lfg	2lfg	1lfg	2lfg	1lfg	2lfg
100	2	16/32	60	100	60	100	60	100	60	100	60	100
120	2	18/36	65	109	65	109	65	109	65	109	65	109
140	2	22/44	70	118	70	118	70	118	70	118	70	118
160	2	26/52	75	127	75	127	75	127	75	127	75	127
180	2	28/54	80	136	80	136	80	136	80	136	80	136
200	2	32/64	85	145	85	145	85	145	85	145	85	145
220	3	34/68	105	179	105	179	105	179	105	179	105	179
240	3	38/76	110	188	110	188	110	188	110	188	110	188
260	3	42/84	115	197	115	197	115	197	115	197	115	197
280	3	44/88	120	206	120	206	120	206	120	206	120	206
300	3	48/96	125	215	125	215	125	215	125	215	125	215
320	3	50/100	130	224	130	224	130	224	130	224	130	224
340	3	54/108	135	233	135	233	135	233	135	233	135	233
360	3	58/116	140	242	140	242	140	242	140	242	140	242
380	3	60/120	145	251	145	251	145	251	145	251	145	251
400	4	64/128	163	286	163	286	163	286	163	286	163	286
+ 20cm	▲	3/6	5	9	5	9	5	9	5	9	5	9

▲ ab einer Länge von ca. 580 cm bzw. bei schwereren Vorhängen wird ein weiterer Träger empfohlen (Aufpreis)

Wandträger RUND - Wandabstand 80mm Stück

	aluminium	871 301 a	17,-
	messing matt	871 301 mm	17,-
	scotch-bright	871 301 sb	17,-
	weiß	871 301 w	17,-
	schwarz	871 301 sw	17,-

Wandträger RUND - Wandabstand 150mm Stück

	aluminium	871 401 a	24,-
	messing matt	871 401 mm	24,-
	scotch-bright	871 401 sb	24,-
	weiß	871 401 w	24,-
	schwarz	871 401 sw	24,-

Wandträger ECKIG - Wandabstand 80mm Stück

	aluminium	871 501 a	17,-
	messing matt	871 501 mm	17,-
	scotch-bright	871 501 sb	17,-
	weiß	871 501 w	17,-
	schwarz	871 501 sw	17,-

Wandträger ECKIG - Wandabstand 150mm Stück

	aluminium	871 601 a	24,-
	messing matt	871 601 mm	24,-
	scotch-bright	871 601 sb	24,-
	weiß	871 601 w	24,-
	schwarz	871 601 sw	24,-

Endkappe Paar

	aluminium	839 930 a	2,80
	messing matt	839 930 mm	2,80
	scotch-bright	839 930 sb	2,80
	weiß	839 930 w	2,80
	schwarz	839 930 sw	2,80

Innenlauf-Profilrohr 20,5x20,5mm, Stange 6m Meter

	aluminium	n90 910 a	20,80
	messing matt	n90 910 mm	20,80
	scotch-bright	n90 910 sb	20,80
	weiß	n90 910 w	20,80
	schwarz	n90 910 sw	20,80

Profilverbinder Messing Stück

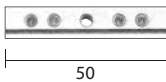
	vernickelt	904 071	12,-
--	------------	---------	------

Profilverbinder Messing, beliebiger Winkel Stück

	vernickelt	904 072 - bw	28,80
--	------------	--------------	-------

Gehungsschnitt (ohne Profilverbinder) Gehrung

	90°	1bg-1gs-90	20,-
	beliebiger Winkel	1bg-1gs-bw	49,-

KLIXI-Drehgleiter 100 Stück Beutel

	Kunststoff grau	2400 100 g	12,-
	Kunststoff weiß	2400 100 w	12,-

Gleiter 100 Stück Beutel

	Kunststoff weiß	3942 100	5,40
---	-----------------	----------	------

Ösengleiter 100 Stück Beutel

	Kunststoff weiß	3910 100	9,90
--	-----------------	----------	------

Gardinen-Einfachhaken 100 Stück Beutel

	Kunststoff weiß	601 100	6,50
---	-----------------	---------	------

Gardinen-Doppelhaken 100 Stück Beutel

	Kunststoff weiß	605 100	11,-
---	-----------------	---------	------

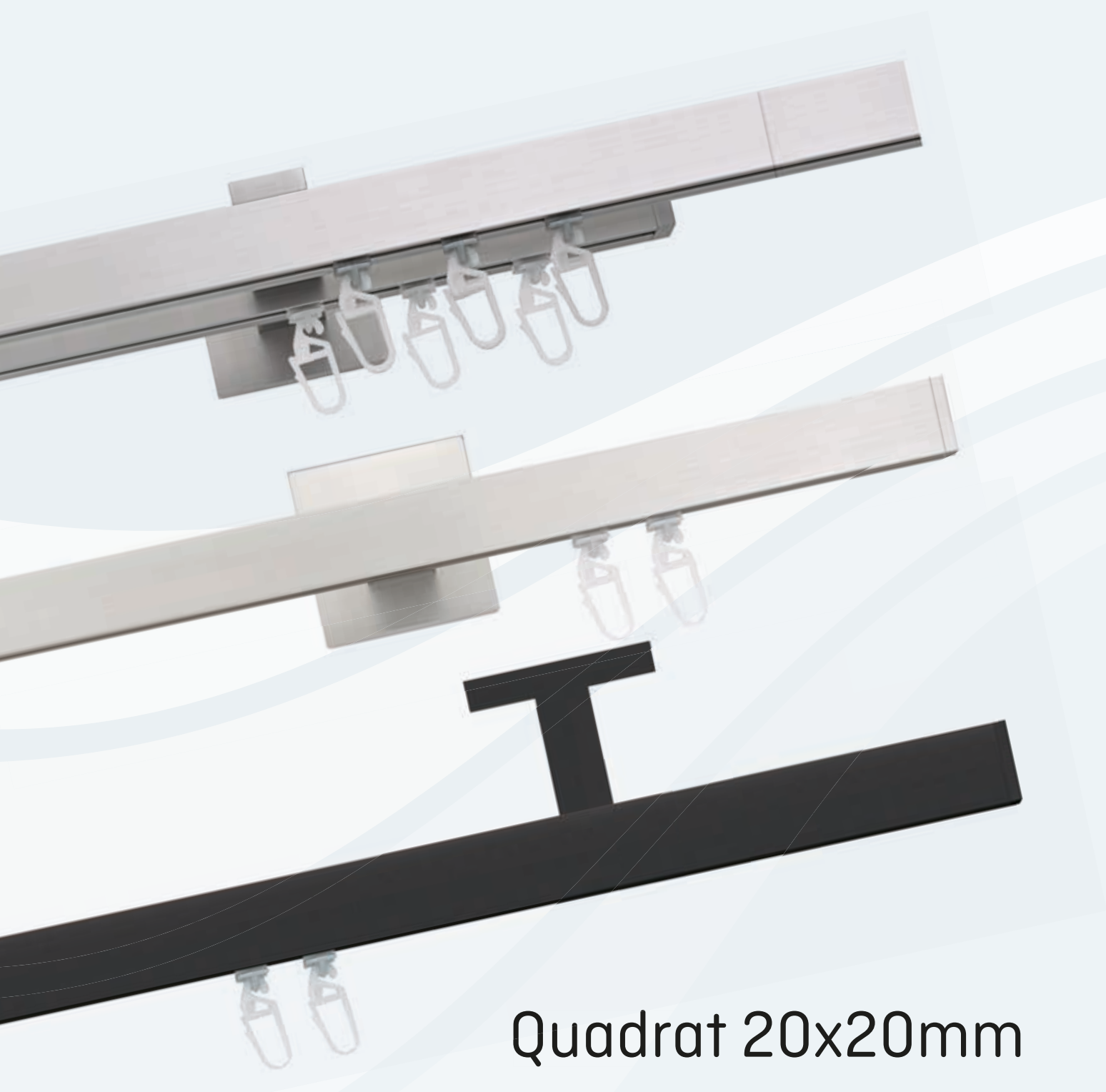

Quadrat 20x20mm

Quadrat 20x20mm - Trägersysteme



Wandträger

Seite 218

Farben Stangen & Zubehör

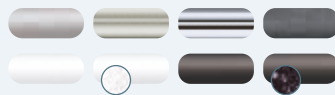

Multi-Wandträger

Seite 220

Farben Stangen & Zubehör

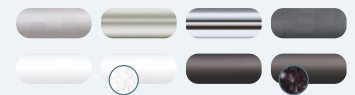

Deckenträger

Seite 222

Farben Stangen & Zubehör

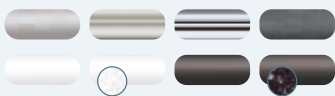

Quadrat 20x20mm - Endknöpfe

Plano flächenbündig

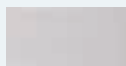

Seite 215

Fina flächenbündig



Seite 215

Quadrat
20x20mm



Plano
FLÄCHENBÜNDIG

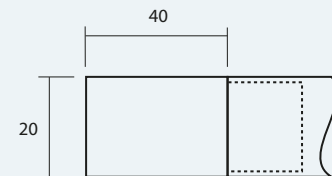

Fina
FLÄCHENBÜNDIG

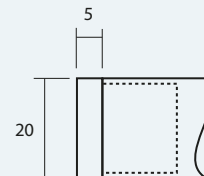

Endknöpfe Quadrat 20x20mm

Plano

FLÄCHENBÜNDIG



nickel matt
Maßstab 1:1



aluminium matt



verchromt



weiss









schwarz matt



anthrazit

Endknopf Plano

Stück

aluminium matt		830 126 am	31,20
nickel matt		830 126 n	38,40
verchromt		830 126 v	38,40
weiß		830 126 w	31,20
anthrazit		830 126 at	38,40
schwarz matt		830 126 sm	31,20

Fina

FLÄCHENBÜNDIG



aluminium matt



verchromt



schwarz matt



nickel matt
Maßstab 1:1



weiss



weiss struktur



anthrazit

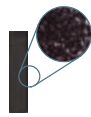

schwarz struktur

Endknopf Fina

Stück

aluminium matt		830 127 am	24,-
nickel matt		830 127 n	28,80
verchromt		830 127 v	28,80
weiß		830 127 w	24,-
weiß struktur		830 127 ws	24,-
anthrazit		830 127 at	28,80
schwarz matt		830 127 sm	24,-
schwarz struktur		830 127 ss	24,-



Erkerausführung



Biegung



Gehung



Gelenk

PROFIL 20-34

Profil
20-34

Quadrat
20x20mm
Wandträger



mit KLIXI
Drehgleiter



mit Wandträger
aluminium matt
2-läufig



mit Multi-Wandträger
Träger verchromt
Profil schwarz matt
1-läufig



mit Deckenträger
schwarz matt
1-läufig

Farben Zubehör & Stangen



aluminium matt



nickel matt



verchromt



schwarz matt



weiß



weiß struktur*

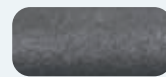

anthrazit*



schwarz struktur*

* IL-Profil in weiß struktur, schwarz struktur, anthrazit: Laufroller Art. 2420

Quadrat 20x20mm

Garnituren mit Wandträgern ohne Endknöpfe

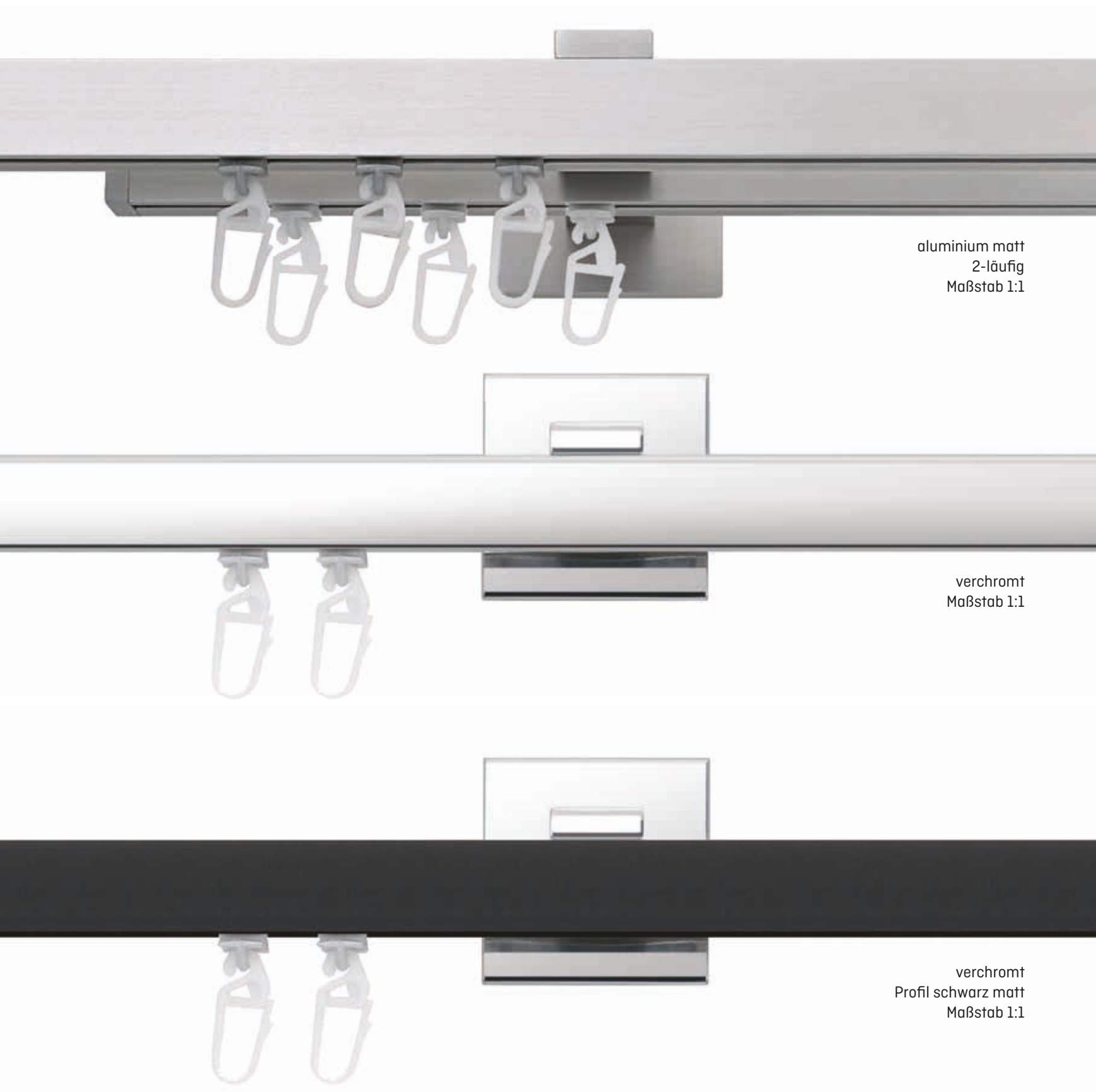



aluminium matt
2-läufig
Maßstab 1:1

verchromt
Maßstab 1:1

verchromt
Profil schwarz matt
Maßstab 1:1

Lieferumfang

- ▶ **1 lfg:** 1 Alu Innenlauf-Profil 20x20mm oberflächenbehandelt, je nach Länge Wandträger und -Drehgleiter lt. Liste
- ▶ **2 lfg:** 2 Alu Innenlauf-Profile 20x20mm oberflächenbehandelt, je nach Länge Wandträger und -Drehgleiter lt. Liste, 2 Endkappen

- ▶ mit Montagematerial
- ▶ Bestellmaß = Profilmaß
- ▶ Trägermitte bis Innenlauf-Profilunterkante: 17mm
- ▶ bei geänderter Ausführung Aufpreis bzw. Preisänderung
- ▶ **Aus produktionstechnischen Gründen bestehen geringfügige Farbabweichungen zwischen den Karniesenkomponenten.**
- ▶ **IL-Profile weiß struktur, schwarz struktur, anthrazit: nur Laufroller Art. 2420 ohne Aufpreis**

Trägermaße



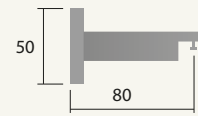



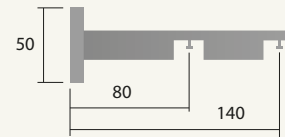



Träger 1-läufig Art. 871 047:



Träger 2-läufig Art. 871 048:



Maße in mm

			aluminium		weiß		weiß struktur		nickel matt		schwarz matt		schwarz struktur		anthrazit		verchromt	
Bestellcode:			t20-181	t20-182	t20-187	t20-188	t20-189	t20-190	t20-183	t20-184	t20-195	t20-196	t20-191	t20-192	t20-193	t20-194	t20-185	t20-186
Länge (cm)	Wand-träger	Gleiter 1l./2l.	1lfg 	2lfg 	1lfg 	2lfg 	1lfg 	2lfg 	1lfg 	2lfg 	1lfg 	2lfg 						
100	2	16/32	164	276	172	290	205	339	228	386								
120	2	18/36	172	293	181	307	215	360	243	416								
140	2	22/44	180	310	190	324	225	381	258	446								
160	2	26/52	188	327	199	341	235	402	273	476								
180	2	28/54	196	344	208	358	245	423	288	506								
200	2	32/64	204	361	217	375	255	444	303	536								
220	3	34/68	275	449	288	471	344	553	395	655								
240	3	38/76	283	466	297	488	354	574	410	685								
260	3	42/84	291	483	306	505	364	595	425	715								
280	3	44/88	299	500	315	522	374	616	440	745								
300	3	48/96	307	517	324	539	384	637	455	775								
320	3	50/100	315	534	333	556	394	658	470	805								
340	3	54/108	323	551	342	573	404	679	485	835								
360	3	58/116	331	568	351	590	414	700	500	865								
380	3	60/120	339	585	360	607	424	721	515	895								
400	4	64/128	411	672	431	704	514	830	606	1.015								
+ 20cm	▲	3/6	8	17	9	17	10	21	15	30								

▲ ab einer Länge von ca. 580 cm bzw. bei schwereren Vorhängen wird ein weiterer Träger empfohlen (Aufpreis)

Garnituren mit Multi-Wandträgern ohne Endknöpfe



nickel matt
Maßstab 1:1



schwarz matt
Maßstab 1:1



verchromt
Maßstab 1:1

Lieferumfang

- ▶ **1 lfg:** 1 Alu Innenlauf-Profil 20x20mm oberflächenbehandelt, je nach Länge Wandträger und -Drehgleiter lt. Liste

- ▶ mit Montagematerial
- ▶ Bestellmaß = Profilmaß
- ▶ Trägermitte bis Innenlauf-Profilunterkante 20x20mm: 8mm
- ▶ bei geänderter Ausführung Aufpreis bzw. Preisänderung
- ▶ **Aus produktionstechnischen Gründen bestehen geringfügige Farbabweichungen zwischen den Karniesenkomponenten.**
- ▶ **IL-Profile weiß struktur, schwarz struktur, anthrazit: nur Laufroller Art. 2420 ohne Aufpreis**

Trägermaße



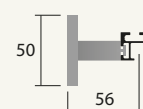



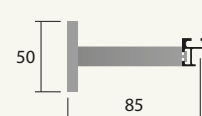



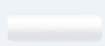



Träger 1-läufig Art. 871 206:



Träger 1-läufig Art. 871 207:



Maße in mm

			 aluminium							
Bestellcode:			t20-131	t20-132						
			 weiß		 weiß struktur		 nickel matt			
Bestellcode:			t20-139	t20-140	t20-141	t20-142	t20-133	t20-134		
			 schwarz matt		 schwarz struktur		 anthrazit		 verchromt	
Bestellcode:			t20-137	t20-138	t20-143	t20-144	t20-145	t20-146	t20-135	t20-136
Länge (cm)	Wand-träger	Gleiter 1l./2l.	1lfg 	1lfg 	1lfg 	1lfg 	1lfg 	1lfg 	1lfg 	1lfg 
100	2	16/32	143	157	150	165	186	198	209	221
120	2	18/36	151	165	159	174	196	208	224	236
140	2	22/44	159	173	168	183	206	218	239	251
160	2	26/52	167	181	177	192	216	228	254	266
180	2	28/54	175	189	186	201	226	238	269	281
200	2	32/64	183	197	195	210	236	248	284	296
220	3	34/68	243	265	255	277	316	333	366	384
240	3	38/76	251	273	264	286	326	343	381	399
260	3	42/84	259	281	273	295	336	353	396	414
280	3	44/88	267	289	282	304	346	363	411	429
300	3	48/96	275	297	291	313	356	373	426	444
320	3	50/100	283	305	300	322	366	383	441	459
340	3	54/108	291	313	309	331	376	393	456	474
360	3	58/116	299	321	318	340	386	403	471	489
380	3	60/120	307	329	327	349	396	413	486	504
400	4	64/128	369	397	387	416	476	500	569	592
+ 20cm	▲	3/6	8	8	9	9	10	10	15	15

▲ ab einer Länge von ca. 580 cm bzw. bei schwereren Vorhängen wird ein weiterer Träger empfohlen (Aufpreis)

Garnituren mit Deckenträgern ohne Endknöpfe



schwarz matt
mit Deckenträger 871 206
Maßstab 1:1



nickel matt
mit Deckenträger 871 215
Maßstab 1:1



verchromt
mit Deckenträger 871 215
Maßstab 1:1

Lieferumfang

- ▶ **1 lfg mit Deckenträger 6mm Deckenabstand:**
1 Alu Innenlauf-Profil 20x20mm oberflächenbehandelt, je nach Länge Deckenträger und -Drehgleiter lt. Liste
- ▶ **1 lfg mit Deckenträger 35mm Deckenabstand:**
1 Alu Innenlauf-Profil 20x20mm oberflächenbehandelt, je nach Länge Deckenträger und -Drehgleiter lt. Liste
- ▶ **1 lfg mit Deckenträger 43mm Deckenabstand:**
1 Alu Innenlauf-Profil 20x20mm oberflächenbehandelt, je nach Länge Deckenträger und -Drehgleiter lt. Liste

- ▶ mit Montagematerial
- ▶ Bestellmaß = Profilmaß
- ▶ Decke bis Innenlauf-Profilunterkante: siehe Maßskizzen rechts
- ▶ bei geänderter Ausführung Aufpreis bzw. Preisänderung
- ▶ **Aus produktionstechnischen Gründen bestehen geringfügige Farbabweichungen zwischen den Karniesenkomponenten.**
- ▶ **IL-Profile weiß struktur, schwarz struktur, anthrazit: nur Laufroller Art. 2420 ohne Aufpreis**

Trägermaße

Träger 1-läufig Art. 871 2091
Deckenabstand 6mm:

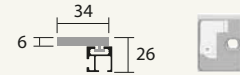

Träger 1-läufig Art. 871 215
Deckenabstand 35mm:

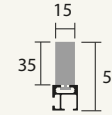

Träger 1-läufig Art. 871 206
Deckenabstand 43mm:

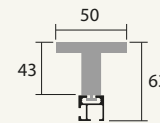

Maße in mm

			aluminium			weiß			weiß struktur			nickel matt			schwarz matt			schwarz struktur			anthrazit			verchromt		
Bestellcode:			t20-161	t20-162	t20-163	t20-155	t20-156	t20-157	t20-158	t20-159	t20-160	t20-164	t20-165	t20-166	t20-170	t20-171	t20-172	t20-173	t20-174	t20-175	t20-176	t20-177	t20-178	t20-167	t20-168	t20-169
Länge (cm)	Wand-träger	Gleiter 1l./2l.	1lfg	1lfg	1lfg	1lfg	1lfg	1lfg	1lfg	1lfg	1lfg	1lfg	1lfg	1lfg	1lfg	1lfg	1lfg	1lfg	1lfg	1lfg	1lfg	1lfg	1lfg	1lfg	1lfg	
100	2	16/32	98	112	143	103	118	150	118	125	186	141	155	209												
120	2	18/36	106	120	151	112	127	159	128	135	196	156	170	224												
140	2	22/44	114	128	159	121	136	168	138	145	206	171	185	239												
160	2	26/52	122	136	167	130	145	177	148	155	216	186	200	254												
180	2	28/54	130	144	175	139	154	186	158	165	226	201	215	269												
200	2	32/64	138	152	183	148	163	195	168	175	236	216	230	284												
220	3	34/68	176	197	243	185	207	255	213	223	316	264	285	366												
240	3	38/76	184	205	251	194	216	264	223	233	326	279	300	381												
260	3	42/84	192	213	259	203	225	273	233	243	336	294	315	396												
280	3	44/88	200	221	267	212	234	282	243	253	346	309	330	411												
300	3	48/96	208	229	275	221	243	291	253	263	356	324	345	426												
320	3	50/100	216	237	283	230	252	300	263	273	366	339	360	441												
340	3	54/108	224	245	291	239	261	309	273	283	376	354	375	456												
360	3	58/116	232	253	299	248	270	318	283	293	386	369	390	471												
380	3	60/120	240	261	307	257	279	327	293	303	396	384	405	486												
400	4	64/128	279	308	369	293	322	387	339	353	476	432	460	569												
+ 20cm	▲	3/6	8	8	8	9	9	9	10	10	10	15	15	15												

▲ ab einer Länge von ca. 580 cm bzw. bei schwereren Vorhängen wird ein weiterer Träger empfohlen (Aufpreis)

Träger und passende Verlängerungen			
Wandträger 1lfg., Wandabstand 80mm			
	aluminium matt	871 047 am	62,40
	verchromt	871 047 v	78,-
	nickel matt	871 047 n	78,-
	weiß	871 047 w	62,40
	weiß struktur	871 047 ws	62,40
	anthrazit	871 047 at	78,-
	schwarz matt	871 047 sm	62,40
	schwarz struktur	871 047 ss	62,40
Wandträger 2lfg., Wandabstand 80/140mm			
	aluminium matt	871 048 am	74,40
	verchromt	871 048 v	91,20
	nickel matt	871 048 n	91,20
	weiß	871 048 w	74,40
	weiß struktur	871 048 ws	74,40
	anthrazit	871 048 at	91,20
	schwarz matt	871 048 sm	74,40
	schwarz struktur	871 048 ss	74,40
Trägerverlängerung 40mm			
	aluminium matt	871 049 4 am	27,60
	verchromt	871 049 4 v	33,60
	nickel matt	871 049 4 n	33,60
	weiß	871 049 4 w	27,60
	weiß struktur	871 049 4 ws	27,60
	anthrazit	871 049 4 at	33,60
	schwarz matt	871 049 4 sm	27,60
	schwarz struktur	871 049 4 ss	27,60
Trägerverlängerung 80mm			
	aluminium matt	871 049 8 am	31,20
	verchromt	871 049 8 v	37,20
	nickel matt	871 049 8 n	37,20
	weiß	871 049 8 w	31,20
	weiß struktur	871 049 8 ws	31,20
	anthrazit	871 049 8 at	37,20
	schwarz matt	871 049 8 sm	31,20
	schwarz struktur	871 049 8 ss	31,20

Quadrat-Profil 20x20mm, Stange 6m			
	aluminium matt	n90 670 am	44,20
	verchromt	n90 670 v	80,-
	nickel matt	n90 670 n	55,20
	weiß	n90 670 w	44,20
	weiß struktur	n90 670 ws	44,20
	anthrazit	n90 670 at	55,20
	schwarz matt	n90 670 sm	44,20
	schwarz struktur	n90 670 ss	44,20

Deckenträger 1lfg., Deckenabstand 6mm			
	aluminium matt	871 2091 am	28,80
	verchromt	871 2091 v	33,60
	nickel matt	871 2091 n	33,60
	weiß	871 2091 w	28,80
	anthrazit	871 2091 at	33,60
	schwarz matt	871 2091 sm	28,80

Profilverbinder Messing			
	vernickelt	904 071	12,-

Profilverbinder Messing, beliebiger Winkel			
	vernickelt	904 072 - bw	28,80

Gehungsschnitt (ohne Profilverbinder)			
	90°	1bg-1gs-90	20,-
	beliebiger Winkel	1bg-1gs-bw	49,-

Träger und passende Verlängerungen			
Deckenträger, Deckenabstand 15mm			
	aluminium matt	871 214 am	32,40
	verchromt	871 214 v	37,20
	nickel matt	871 214 n	37,20
	weiß	871 214 w	32,40
	weiß struktur	871 214 ws	32,40
	anthrazit	871 214 at	37,20
	schwarz matt	871 214 sm	32,40
	schwarz struktur	871 214 ss	32,40
Deckenträger, Deckenabstand 35mm			
	aluminium matt	871 215 am	36,-
	verchromt	871 215 v	40,80
	nickel matt	871 215 n	40,80
	weiß	871 215 w	36,-
	weiß struktur	871 215 ws	36,-
	anthrazit	871 215 at	40,80
	schwarz matt	871 215 sm	36,-
	schwarz struktur	871 215 ss	36,-
Wand-/Deckenträger 1lfg., Wandabstand 43mm			
	aluminium matt	871 206 am	51,60
	verchromt	871 206 v	68,40
	nickel matt	871 206 n	68,40
	weiß	871 206 w	51,60
	weiß struktur	871 206 ws	51,60
	anthrazit	871 206 at	68,40
	schwarz matt	871 206 sm	51,60
	schwarz struktur	871 206 ss	51,60
Wand-/Deckenträger 1lfg., Wandabstand 80mm			
	aluminium matt	871 207 am	58,80
	verchromt	871 207 v	74,40
	nickel matt	871 207 n	74,40
	weiß	871 207 w	58,80
	weiß struktur	871 207 ws	58,80
	anthrazit	871 207 at	74,40
	schwarz matt	871 207 sm	58,80
	schwarz struktur	871 207 ss	58,80
Trägerverlängerung 35mm			
	aluminium matt	871 208 am	27,60
	verchromt	871 208 v	33,60
	nickel matt	871 208 n	33,60
	weiß	871 208 w	27,60
	weiß struktur	871 208 ws	27,60
	anthrazit	871 208 at	33,60
	schwarz matt	871 208 sm	27,60
	schwarz struktur	871 208 ss	27,60

KLIXI-Drehgleiter 100 Stück			
	Kunststoff grau	2400 100 g	12,-
	Kunststoff weiß	2400 100 w	12,-

Gleiter 100 Stück			
	Kunststoff weiß	3942 100	5,40

Ösengleiter 100 Stück			
	Kunststoff weiß	3910 100	9,90

Gardinen-Doppelhaken 100 Stück			
	Kunststoff weiß	605 100	11,-

Roller mit Faltenleghaken			
	Kunststoff weiß	2420	0,20

Biegungen siehe Gruppe 10



PROFIL 20-34

Profil
20-34

34x14mm

 mit KLIXI
Drehgleiter

Erkerausführung



Biegung



Gehung



Gelenk



Farben Zubehör & Stangen



aluminium

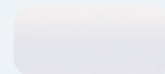

weiß



schwarz

Eckig 34x14mm

Komplettgarnituren Eckig 34x14mm inkl. Endkappen





Farbe aluminium
1-läufige Wandträger
Maßstab 1:1



Farbe aluminium
2-läufige Wandträger
Maßstab 1:1

Lieferumfang

- ▶ **1 lfg:** 1 Alu Innenlauf-Profil 34x14 mm oberflächenbehandelt, je nach Länge Wandträger ECKIG und -Drehgleiter lt. Liste, 2 Endkappen
- ▶ **2 lfg:** 2 Alu Innenlauf-Profile 34x14 mm oberflächenbehandelt, je nach Länge Wandträger ECKIG und -Drehgleiter lt. Liste, 4 Endkappen

- ▶ mit Montagematerial
- ▶ Bestellmaß = Profilmaß
- ▶ Trägeroberkante bis Innenlauf-Profilunterkante: 37mm
- ▶ bei geänderter Ausführung Aufpreis bzw. Preisabschlag
- ▶ **Aus produktionstechnischen Gründen bestehen geringfügige Farbabweichungen zwischen den Karniesenkomponenten.**

Trägermaße







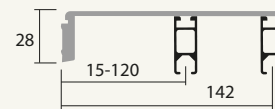

Wandträger ECKIG 1-läufig:



Wandträger ECKIG 2-läufig:



Maße in mm

			 aluminium		 weiß		 schwarz	
Bestellcode:			t20-088	t20-089	t20-098	t20-099	t20-074	t20-075
Länge (cm)	Wand-träger	Gleiter 1l./2l.	 1lfg	 2lfg	 1lfg	 2lfg	 1lfg	 2lfg
100	2	16/32	81	139	81	137	85	146
120	2	18/36	87	151	87	148	93	161
140	2	22/44	93	163	93	159	101	176
160	2	26/52	99	175	99	170	109	191
180	2	28/54	105	187	105	181	117	206
200	2	32/64	111	199	111	192	125	221
220	3	34/68	137	237	136	234	151	266
240	3	38/76	143	249	142	245	159	281
260	3	42/84	149	261	148	256	167	296
280	3	44/88	155	273	154	267	175	311
300	3	48/96	161	285	160	278	183	326
320	3	50/100	167	297	166	289	191	341
340	3	54/108	173	309	172	300	199	356
360	3	58/116	179	321	178	311	207	371
380	3	60/120	185	333	184	322	215	386
400	4	64/128	210	371	209	365	240	431
+ 20cm	▲	3/6	6	12	6	11	8	15

▲ ab einer Länge von ca. 580 cm bzw. bei schwereren Vorhängen wird ein weiterer Träger empfohlen (Aufpreis)

Wandträger 1lfg - Wandabstand 80mm Stück

	aluminium	871 501 a	17,-
	weiß	871 501 w	17,-
	schwarz	871 501 sw	17,-

Wandträger 2lfg - Wandabstand 150mm Stück

	aluminium	871 601 a	24,-
	weiß	871 601 w	24,-
	schwarz	871 601 sw	24,-

Endkappe Stück

	Kunststoff grau	904 041 gr	6,50
	Kunststoff weiß	904 041 w	6,50
	Kunststoff schwarz	904 041 sw	6,50

Innenlauf-Profilrohr 34x14mm, Stange 6m Meter

	aluminium	n90 458 ne	26,80
	weiß	n90 458 w	26,80
	schwarz	n90 458 sw	26,80

Profilverbinder Messing Stück

	vernickelt	904 071	12,-
	50		

Profilverbinder Messing, beliebiger Winkel Stück

	vernickelt	904 072 - bw	28,80
	45		

Gehungsschnitt (ohne Profilverbinder) Gehrung

	90°	1bg-1gs-90	20,-
	beliebiger Winkel	1bg-1gs-bw	49,-

KLIXI-Drehgleiter 100 Stück Beutel

	Kunststoff grau	2400 100 g	12,-
	Kunststoff weiß	2400 100 w	12,-

Gleiter 100 Stück Beutel

	Kunststoff weiß	3942 100	5,40
---	-----------------	----------	------

Ösengleiter 100 Stück Beutel

	Kunststoff weiß	3910 100	9,90
---	-----------------	----------	------

Gardinen-Einfachhaken 100 Stück Beutel

	Kunststoff weiß	601 100	6,50
---	-----------------	---------	------

Gardinen-Doppelhaken 100 Stück Beutel

	Kunststoff weiß	605 100	11,-
---	-----------------	---------	------

Roller mit Faltenleghaken Stück

	Kunststoff weiß	2420	0,20
---	-----------------	------	------

 Biegungen siehe Gruppe 10



Profil 40-70 mm

Rechteck 40x15 mm



Wandträger Seite 233

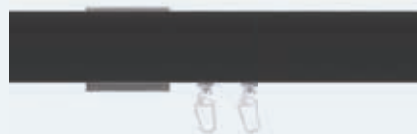

Multi-Wandträger Seite 236



Deckenträger Seite 238

Rechteck 40x15 mm - Endknöpfe

Valerie flächenbündig



Seite 231

Mirella flächenbündig



Seite 231

Farben Stangen & Zubehör

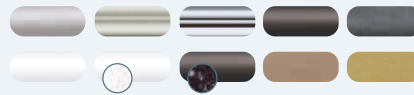

Oval 40x22 mm



Wandträger Seite 246



Multi-Wandträger Seite 248



Deckenträger Seite 250

Oval 40x22 mm - Endknöpfe

Melissa flächenbündig



Seite 243

Tamara flächenbündig



Seite 243

Farben Stangen & Zubehör



Oval 70x22 mm

Farben Stangen & Zubehör



Wandträger Seite 254



Multi-Wandträger Seite 256



Deckenträger Seite 258

C-Profil/V-Profil 70 mm



C-Profil 70x57mm

Seite 263

Farben Stangen & Zubehör



V-Profil 70x57mm

Seite 267

Farben Stangen & Zubehör



Blendsystem Flach 60 mm



Multi-Wandträger

Seite 272

Farben Stangen & Zubehör



Deckenträger

Seite 274

Farben Stangen & Zubehör





Rechteck 40x15mm

Rechteck 40x15mm - Trägersysteme



Wandträger

Seite 234

Farben Stangen & Zubehör



Multi-Wandträger

Seite 236

Farben Stangen & Zubehör



Deckenträger

Seite 238

Farben Stangen & Zubehör

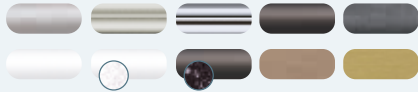

Rechteck 40x15mm - Endknöpfe





Valerie
FLÄCHENBÜNDIG

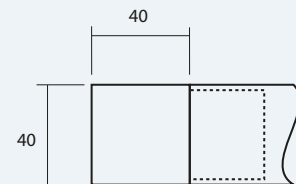

Mirella
FLÄCHENBÜNDIG

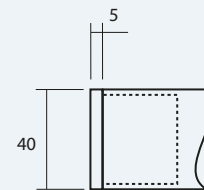

Endknöpfe Rechteck 40x15mm

Valerie

FLÄCHENBÜNDIG



Endknopf Valerie		Stück
aluminium matt	830 121 am	33,60
nickel matt	830 121 n	40,80
verchromt	830 121 v	40,80
schwarz matt	830 121 sm	33,60
weiß	830 121 w	33,60
weiß struktur	830 121 ws	33,60
anthrazit	830 121 at	40,80
schwarz struktur	830 121 ss	33,60
palladium gebürstet	830 121 pg	40,80
gold gebürstet	830 121 gg	40,80

Mirella

FLÄCHENBÜNDIG



Endknopf Mirella		Stück
aluminium matt	830 123 am	26,40
nickel matt	830 123 n	30,-
verchromt	830 123 v	30,-
schwarz matt	830 123 sm	26,40
weiß	830 123 w	26,40
weiß struktur	830 123 ws	26,40
anthrazit	830 123 at	30,-
schwarz struktur	830 123 ss	26,40
palladium gebürstet	830 123 pg	30,-
gold gebürstet	830 123 gg	30,-



mit KLIXI
Drehgleiter

Erkerausführung



Biegung



Gehrung



Gelenk



aluminium matt
2-läufig



mit Deckenträger

Farben Zubehör & Stangen



palladium
gebürstet

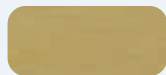

gold
gebürstet



aluminium matt



nickel matt



verchromt



schwarz matt

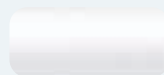

weiß

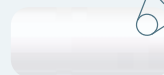

weiß struktur*



anthrazit*



schwarz struktur*

* IL-Profile in weiß struktur, schwarz struktur, anthrazit: Laufroller Art. 2420

Rechteck 40x15mm

Garnituren mit Wandträgern ohne Endknöpfe

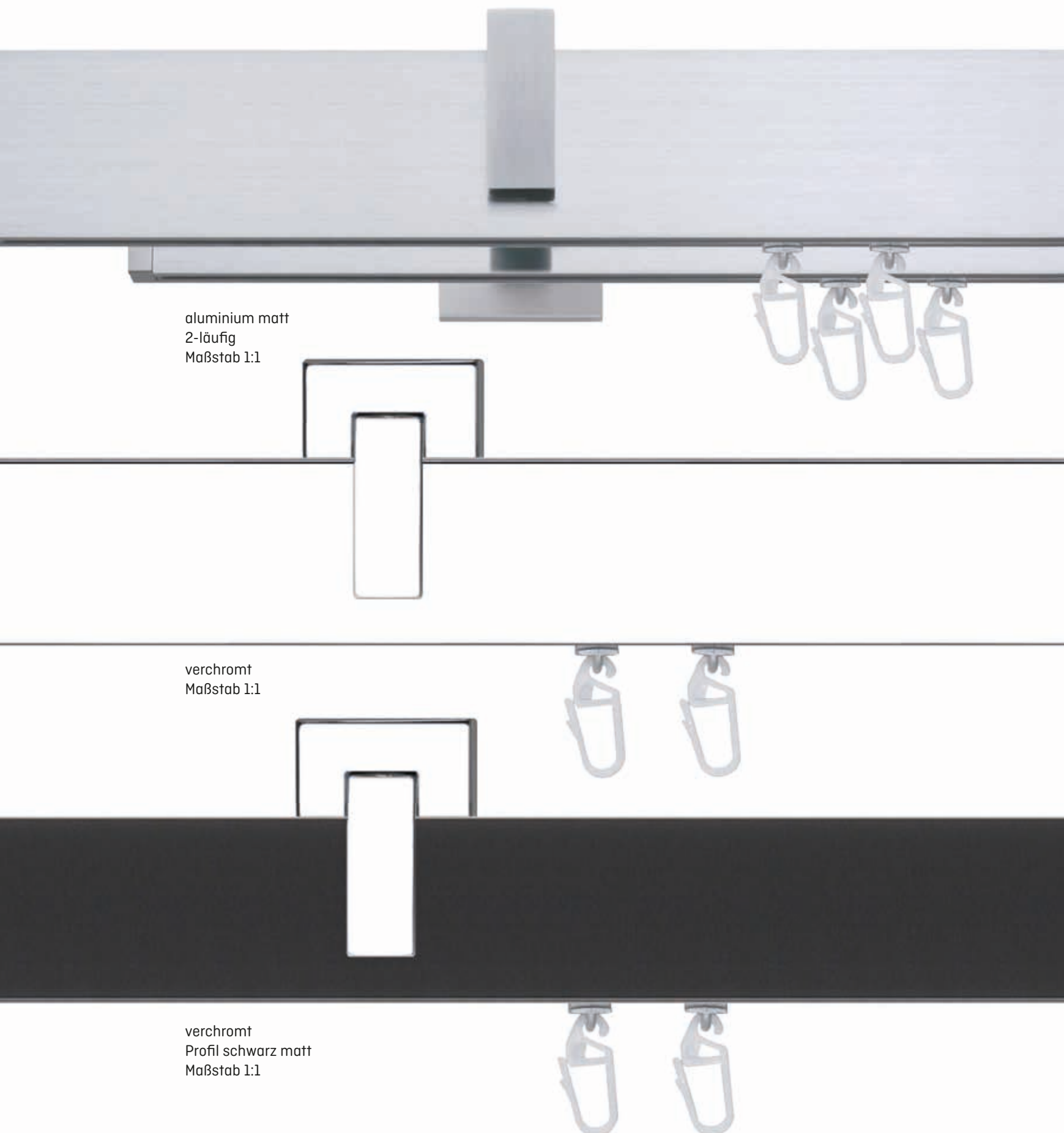

Lieferumfang

- ▶ **1 lfg:** 1 Alu Innenlauf-Profil 40x15mm oberflächenbehandelt, je nach Länge Wandträger und -Drehgleiter lt. Liste
 - ▶ **2 lfg:** 2 Alu Innenlauf-Profile 40x15mm oberflächenbehandelt, je nach Länge Wandträger und -Drehgleiter lt. Liste, 2 Endkappen
- ▶ mit Montagematerial
 - ▶ Bestellmaß = Profilmaß
 - ▶ Trägermitte bis Innenlauf-Profilunterkante: 30mm
 - ▶ bei geänderter Ausführung Aufpreis bzw. Preisänderung
 - ▶ **Aus produktionstechnischen Gründen bestehen geringfügige Farbabweichungen zwischen den Karniesenkomponenten.**
 - ▶ **IL-Profile weiß struktur, schwarz struktur, anthrazit: nur Laufroller Art. 2420 ohne Aufpreis**

Trägermaße

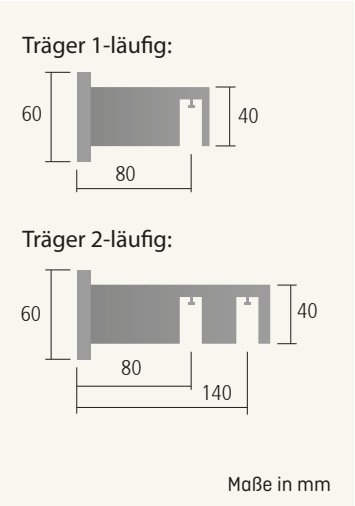

Bestellcode:			t40-217	t40-218						
Bestellcode:			t40-219	t40-220	t40-201	t40-202				
Bestellcode:			t40-215	t40-216	t40-209	t40-210	t40-211	t40-212		
Bestellcode:			t40-203	t40-204	t40-207	t40-208	t40-213	t40-214	t40-205	t40-206
Länge (cm)	Wand-träger	Gleiter 1l./2l.	1lfg	2lfg	1lfg	2lfg	1lfg	2lfg	1lfg	2lfg
100	2	16/32	240	403	188	311	188	311	280	482
120	2	18/36	253	428	198	331	198	331	301	523
140	2	22/44	266	453	208	351	208	351	322	564
160	2	26/52	279	478	218	371	218	371	343	605
180	2	28/54	292	503	228	391	228	391	364	646
200	2	32/64	305	528	238	411	238	411	385	687
220	2	34/68	318	553	248	431	248	431	406	728
240	3	38/76	417	689	327	529	327	529	513	880
260	3	42/84	430	714	337	549	337	549	534	921
280	3	44/88	443	739	347	569	347	569	555	962
300	3	48/96	456	764	357	589	357	589	576	1.003
320	3	50/100	469	789	367	609	367	609	597	1.044
340	3	54/108	482	814	377	629	377	629	618	1.085
360	3	58/116	495	839	387	649	387	649	639	1.126
380	3	60/120	508	864	397	669	397	669	660	1.167
400	3	64/128	521	889	407	689	407	689	681	1.208
+ 20cm	▲	3/6	13	25	10	20	10	20	21	41

▲ ab einer Länge von ca. 420 cm bzw. bei schwereren Vorhängen wird ein weiterer Träger empfohlen (Aufpreis)

Garnituren mit Multi-Wandträgern ohne Endknöpfe

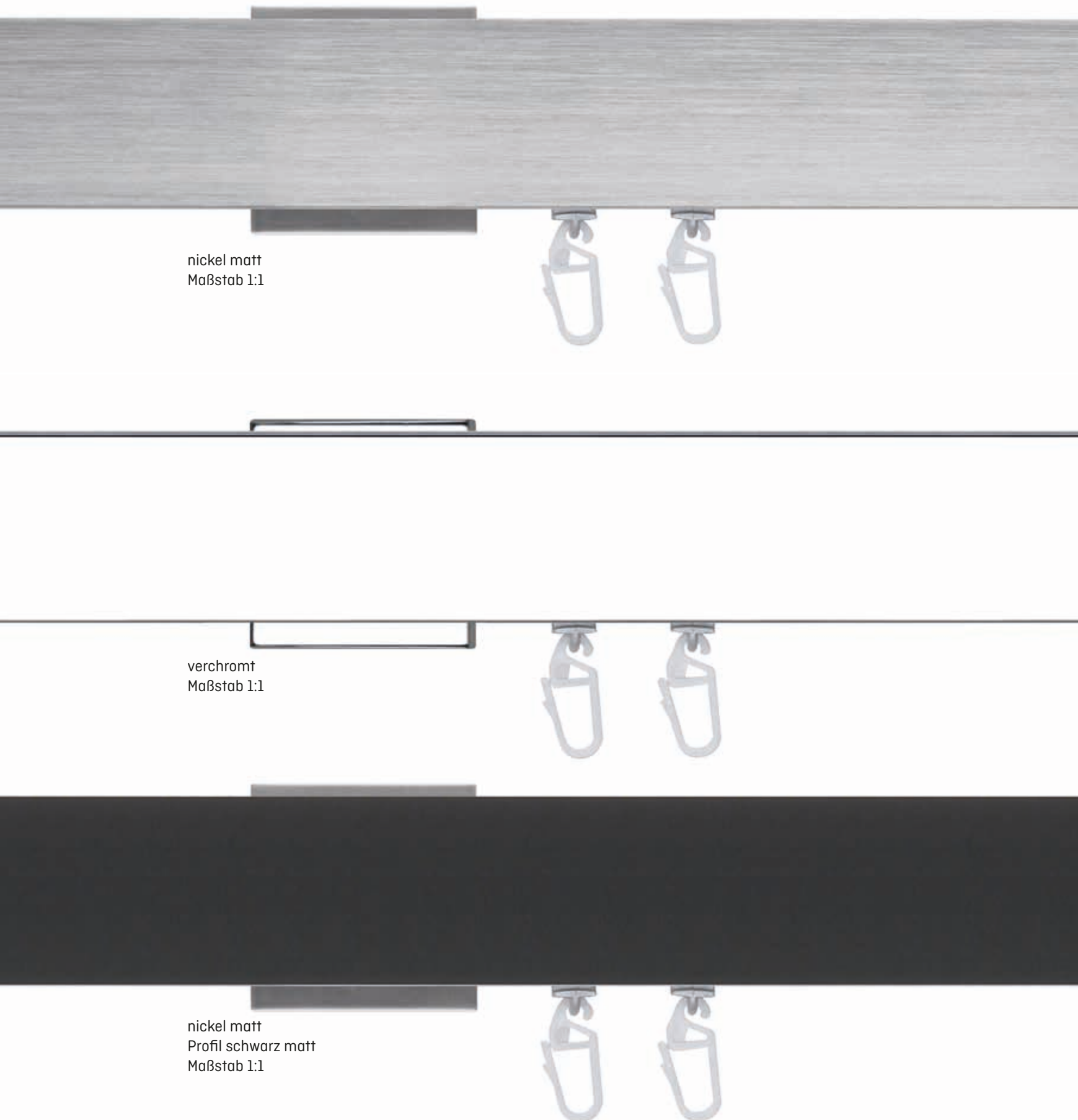

nickel matt
Maßstab 1:1

verchromt
Maßstab 1:1

nickel matt
Profil schwarz matt
Maßstab 1:1

Lieferumfang

- ▶ **1 lfg:** 1 Alu Innenlauf-Profil 40x15mm oberflächenbehandelt, je nach Länge Wandträger und Klix®-Drehgleiter lt. Liste
- ▶ **2-/3-lfg:** 1 Alu Innenlauf-Profil 40x15mm oberflächenbehandelt, 1 bzw. 2 Alu Innenlauf-Profile 20x20mm oberflächenbehandelt, je nach Länge Wandträger und Klix®-Drehgleiter lt. Liste, 2 bzw. 4 Endkappen

- ▶ mit Montagematerial
- ▶ Bestellmaß = Profilmaß
- ▶ Trägermitte bis Innenlauf-Profilunterkante 40x15mm: 27mm
- ▶ Trägermitte bis Innenlauf-Profilunterkante 20x20mm: 28mm
- ▶ bei geänderter Ausführung Aufpreis bzw. Preisänderung
- ▶ **Aus produktionstechnischen Gründen bestehen geringfügige Farbabweichungen zwischen den Karniesenkomponenten.**

Trägermaße

Träger 1-läufig Art. 871 207:

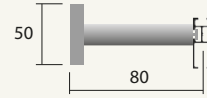

Träger 2-/3-läufig Art. 871 2281:

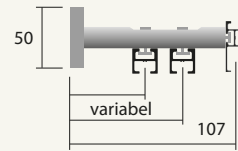

Maße in mm

				aluminium matt			nickel matt			verchromt			schwarz matt		
Bestellcode:				t40-231	t40-232	t40-233	t40-234	t40-235	t40-236	t40-237	t40-238	t40-239	t40-240	t40-241	t40-242
Länge (cm)	Wandträger		Gleiter pro Lauf	1lfg	2lfg	3lfg	1lfg	2lfg	3lfg	1lfg	2lfg	3lfg	1lfg	2lfg	3lfg
	871 207	871 2281		1lfg	2lfg	3lfg	1lfg	2lfg	3lfg	1lfg	2lfg	3lfg	1lfg	2lfg	3lfg
100	2	2	16	165	265	354	210	307	411	249	367	493	165	265	354
120	2	2	18	175	283	380	223	329	443	270	401	541	175	283	380
140	2	2	22	185	301	406	236	351	475	291	435	589	185	301	406
160	2	2	26	195	319	432	249	373	507	312	469	637	195	319	432
180	2	2	28	205	337	458	262	395	539	333	503	685	205	337	458
200	2	2	32	215	355	484	275	417	571	354	537	733	215	355	484
220	2	3	34	225	438	576	288	511	673	375	643	854	225	438	576
240	3	3	38	292	456	602	371	533	705	467	677	902	292	456	602
260	3	3	42	302	474	628	384	555	737	488	711	950	302	474	628
280	3	3	44	312	492	654	397	577	769	509	745	998	312	492	654
300	3	3	48	322	510	680	410	599	801	530	779	1.046	322	510	680
320	3	3	50	332	528	706	423	621	833	551	813	1.094	332	528	706
340	3	3	54	342	546	732	436	643	865	572	847	1.142	342	546	732
360	3	3	58	352	564	758	449	665	897	593	881	1.190	352	564	758
380	3	3	60	362	582	784	462	687	929	614	915	1.238	362	582	784
400	3	4	64	372	665	879	475	780	1.032	635	1.020	1.360	372	665	879
+ 20cm ▲			3	10	18	26	13	22	32	21	34	48	10	18	26

- ▲ Träger 871207: ab einer Länge von 420 cm bzw. bei schwereren Vorhängen wird ein weiterer Träger empfohlen
- ▲ Träger 8712281: ab einer Länge von 580 cm bzw. bei schwereren Vorhängen wird ein weiterer Träger empfohlen

Garnituren mit Deckenträgern ohne Endknöpfe

aluminium matt
mit Deckenträger 871 215
Maßstab 1:1



nickel matt
mit Deckenträger 871 2091
Maßstab 1:1



nickel matt
mit Deckenträger 871 2091
Profil schwarz matt
Maßstab 1:1



Lieferumfang

- ▶ 1 lfg mit Deckenträger 6mm Deckenabstand
- ▶ 1 lfg mit Deckenträger 35mm Deckenabstand
- ▶ 1 lfg mit Deckenträger 43mm Deckenabstand
- ▶ 1 Alu Innenlauf-Profil 40x15mm oberflächenbehandelt, je nach Länge Deckenträger und -Drehgleiter lt. Liste





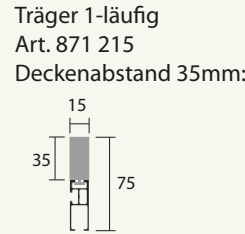
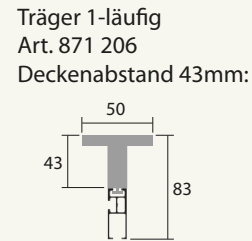
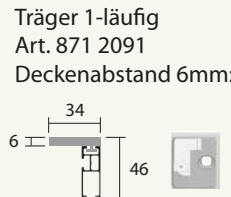







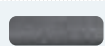
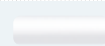

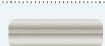







- ▶ mit Montagematerial,
- ▶ Bestellmaß = Profilmaß
- ▶ Decke bis Innenlauf-Profilunterkante: siehe Maßskizzen rechts
- ▶ bei geänderter Ausführung Aufpreis bzw. Preisänderung
- ▶ **Aus produktionstechnischen Gründen bestehen geringfügige Farbabweichungen zwischen den Karniesenkomponenten.**
- ▶ **IL-Profile weiß struktur, schwarz struktur, anthrazit: nur Laufroller Art. 2420 ohne Aufpreis**

Trägermaße



Maße in mm

Profil
40-70

																																
Bestellcode:			t40-285	t40-286	t40-287	t40-288	t40-289	t40-290	t40-261	t40-262	t40-263	t40-282	t40-283	t40-284	t40-273	t40-274	t40-275	t40-276	t40-277	t40-278	t40-264	t40-265	t40-266	t40-270	t40-271	t40-272	t40-279	t40-280	t40-281	t40-267	t40-268	t40-269
Länge (cm)	Wand-träger	Gleiter 1l./2l.	1lfg 	1lfg 	1lfg 	1lfg 	1lfg 	1lfg 	1lfg 	1lfg 	1lfg 	1lfg 	1lfg 	1lfg 	1lfg 	1lfg 	1lfg 	1lfg	1lfg	1lfg	1lfg	1lfg	1lfg	1lfg	1lfg	1lfg	1lfg	1lfg	1lfg			
100	2	16/32	129	144	198	106	120	151	106	120	151	169	183	238																		
120	2	18/36	142	157	211	116	130	161	116	130	161	190	204	259																		
140	2	22/44	155	170	224	126	140	171	126	140	171	211	225	280																		
160	2	26/52	168	183	237	136	150	181	136	150	181	232	246	301																		
180	2	28/54	181	196	250	146	160	191	146	160	191	253	267	322																		
200	2	32/64	194	209	263	156	170	201	156	170	201	274	288	343																		
220	2	34/68	207	222	276	166	180	211	166	180	211	295	309	364																		
240	3	38/76	251	272	354	203	224	270	203	224	270	347	368	449																		
260	3	42/84	264	285	367	213	234	280	213	234	280	368	389	470																		
280	3	44/88	277	298	380	223	244	290	223	244	290	389	410	491																		
300	3	48/96	290	311	393	233	254	300	233	254	300	410	431	512																		
320	3	50/100	303	324	406	243	264	310	243	264	310	431	452	533																		
340	3	54/108	316	337	419	253	274	320	253	274	320	452	473	554																		
360	3	58/116	329	350	432	263	284	330	263	284	330	473	494	575																		
380	3	60/120	342	363	445	273	294	340	273	294	340	494	515	596																		
400	3	64/128	355	376	458	283	304	350	283	304	350	515	536	617																		
+ 20cm	▲	3/6	13	13	13	10	10	10	10	10	10	21	21	21																		

▲ ab einer Länge von ca. 420 cm bzw. bei schwereren Vorhängen wird ein weiterer Träger empfohlen (Aufpreis)

Träger und passende Verlängerungen			
Wandträger 1fg., Wandabstand 80mm			
	aluminium matt	871 203 am	70,80
	verchromt	871 203 v	90,-
	nickel matt	871 203 n	90,-
	weiß	871 203 w	70,80
	weiß struktur	871 203 ws	70,80
	anthrazit	871 203 at	90,-
	schwarz matt	871 203 sm	70,80
	schwarz struktur	871 203 ss	70,80
	palladium gebürstet	871 203 pg	90,-
	gold gebürstet	871 203 gg	90,-
Wandträger 2fg., Wandabstand 80/140mm			
	aluminium matt	871 204 am	81,60
	verchromt	871 204 v	110,40
	nickel matt	871 204 n	110,40
	weiß	871 204 w	81,60
	weiß struktur	871 204 ws	81,60
	anthrazit	871 204 at	110,40
	schwarz matt	871 204 sm	81,60
	schwarz struktur	871 204 ss	81,60
	palladium gebürstet	871 204 pg	110,40
	gold gebürstet	871 204 gg	110,40
Trägerverlängerung 40mm			
	aluminium matt	871 210 am	37,20
	verchromt	871 210 v	45,60
	nickel matt	871 210 n	45,60
	weiß	871 210 w	37,20
	weiß struktur	871 210 ws	37,20
	anthrazit	871 210 at	45,60
	schwarz matt	871 210 sm	37,20
	schwarz struktur	871 210 ss	37,20
	palladium gebürstet	871 210 pg	45,60
	gold gebürstet	871 210 gg	45,60
Trägerverlängerung 80mm			
	aluminium matt	871 211 am	42,-
	verchromt	871 211 v	50,40
	nickel matt	871 211 n	50,40
	weiß	871 211 w	42,-
	weiß struktur	871 211 ws	42,-
	anthrazit	871 211 at	50,40
	schwarz matt	871 211 sm	42,-
	schwarz struktur	871 211 ss	42,-
	palladium gebürstet	871 211 pg	50,40
	gold gebürstet	871 211 gg	50,40

Träger und passende Verlängerungen			
Multi-Wandträger 1-3fg., Wandabstand 100mm			
	aluminium matt	871 2281 am	64,80
	verchromt	871 2281 v	76,80
	nickel matt	871 2281 n	76,80
	schwarz matt	871 2281 sm	64,80
Multi-Wandträger 1-5fg., Wandabstand 140mm			
	aluminium matt	871 2282 am	70,80
	verchromt	871 2282 v	82,80
	nickel matt	871 2282 n	82,80
	schwarz matt	871 2282 sm	70,80
Trägerverlängerung für Multi-Wandträger 40mm			
	aluminium matt	871 044 am	21,60
	verchromt	871 044 v	21,60
	nickel matt	871 044 n	21,60
	schwarz matt	871 044 sm	21,60
Trägerverlängerung für Multi-Wandträger 80mm			
	aluminium matt	871 066 am	24,-
	verchromt	871 066 v	24,-
	nickel matt	871 066 n	24,-
	schwarz matt	871 066 sm	24,-

Träger und passende Verlängerungen			
Deckenträger, Deckenabstand 15mm			
	aluminium matt	871 214 am	32,40
	verchromt	871 214 v	37,20
	nickel matt	871 214 n	37,20
	weiß	871 214 w	32,40
	weiß struktur	871 214 ws	32,40
	anthrazit	871 214 at	37,20
	schwarz matt	871 214 sm	32,40
	schwarz struktur	871 214 ss	32,40
	palladium gebürstet	871 214 pg	37,20
	gold gebürstet	871 214 gg	37,20
Deckenträger, Deckenabstand 35mm			
	aluminium matt	871 215 am	36,-
	verchromt	871 215 v	40,80
	nickel matt	871 215 n	40,80
	weiß	871 215 w	36,-
	weiß struktur	871 215 ws	36,-
	anthrazit	871 215 at	40,80
	schwarz matt	871 215 sm	36,-
	schwarz struktur	871 215 ss	36,-
	palladium gebürstet	871 215 pg	40,80
	gold gebürstet	871 215 gg	40,80
Wand-/Deckenträger 1fg., Wandabstand 43mm			
	aluminium matt	871 206 am	51,60
	verchromt	871 206 v	68,40
	nickel matt	871 206 n	68,40
	weiß	871 206 w	51,60
	weiß struktur	871 206 ws	51,60
	anthrazit	871 206 at	68,40
	schwarz matt	871 206 sm	51,60
	schwarz struktur	871 206 ss	51,60
	palladium gebürstet	871 206 pg	68,40
	gold gebürstet	871 206 gg	68,40
Wand-/Deckenträger 1fg., Wandabstand 80mm			
	aluminium matt	871 207 am	58,80
	verchromt	871 207 v	74,40
	nickel matt	871 207 n	74,40
	schwarz matt	871 207 sm	58,80
Trägerverlängerung 35mm			
	aluminium matt	871 208 am	27,60
	verchromt	871 208 v	33,60
	nickel matt	871 208 n	33,60
	schwarz matt	871 208 sm	27,60

Deckenträger 1fg., Deckenabstand 6mm			
	aluminium matt	871 2091 am	28,80
	verchromt	871 2091 v	33,60
	nickel matt	871 2091 n	33,60
	weiß	871 2091 w	28,80
	anthrazit	871 2091 at	33,60
	schwarz matt	871 2091 sm	28,80
	palladium gebürstet	871 2091 pg	33,60
	gold gebürstet	871 2091 gg	33,60

Biegungen siehe Gruppe 10

Endkappe flächenbündig Rechteck 40x15mm		Stück	
	aluminium matt	830 123 am	26,40
	verchromt	830 123 v	30,-
	nickel matt	830 123 n	30,-
	weiß	830 123 w	26,40
	weiß struktur	830 123 ws	26,40
	anthrazit	830 123 at	30,-
	schwarz matt	830 123 sm	26,40
	schwarz struktur	830 123 ss	26,40
	palladium gebürstet	830 123 pg	30,-
	gold gebürstet	830 123 gg	30,-

Endkappe flächenbündig Quadrat 20x20mm		Stück	
	aluminium matt	830 127 am	24,-
	verchromt	830 127 v	28,80
	nickel matt	830 127 n	28,80
	schwarz matt	830 127 sm	24,-

Gelenkverbinder für Rechteck 40x15mm		Stück	
	aluminium matt	89 40 am	82,80
	verchromt	89 40 v	94,80
	nickel matt	89 40 n	94,80
	schwarz matt	89 40 sm	82,80

Rechteck-Innenlauf-Profil 40x15mm, Stange 6m		Meter	
	aluminium matt	n90 740 am	52,40
	verchromt	n90 740 v	110,40
	nickel matt	n90 740 n	67,60
	weiß	n90 740 w	52,40
	weiß struktur	n90 740 ws	52,40
	anthrazit	n90 740 at	67,60
	schwarz matt	n90 740 sm	52,40
	schwarz struktur	n90 740 ss	52,40
	palladium gebürstet	n90 740 pg	67,60
	gold gebürstet	n90 740 gg	67,60

Quadrat-Innenlauf-Profil 20x20mm, Stange 6m		Meter	
	aluminium matt	n90 670 am	44,20
	verchromt	n90 670 v	80,-
	nickel matt	n90 670 n	55,20
	schwarz matt	n90 670 sm	44,20

Profilverbinder Messing		Stück	
	vernickelt	904 071	12,-

Profilverbinder Messing, beliebiger Winkel		Stück	
	vernickelt	904 072 - bw	28,80

Gehrungsschnitt (ohne Profilverbinder)		Gehrung	
	90°	1bg-1gs-90	20,-
	beliebiger Winkel	1bg-1gs-bw	49,-

KLIXI-Drehgleiter 100 Stück		Beutel	
	Kunststoff grau	2400 100 g	12,-
	Kunststoff weiß	2400 100 w	12,-

Gleiter 100 Stück		Beutel	
	Kunststoff weiß	3942 100	5,40

Ösengleiter 100 Stück		Beutel	
	Kunststoff weiß	3910 100	9,90

Gardinen-Einfachhaken 100 Stück		Beutel	
	Kunststoff weiß	601 100	6,50

Gardinen-Doppelhaken 100 Stück		Beutel	
	Kunststoff weiß	605 100	11,-

Roller mit Faltenleghaken		Stück	
	Kunststoff weiß	2420	0,20

Roller mit Kugellager nur für Profil n90740		Stück	
	Kunststoff	904 074	1,10



Oval 40x22mm

Oval 40x22mm - Trägersysteme



Wandträger

Seite 246

Farben Stangen & Zubehör



Multi-Wandträger

Seite 248

Farben Stangen & Zubehör



Deckenträger

Seite 250

Farben Stangen & Zubehör



Oval 40x22mm - Endknöpfe

Melissa flächenbündig



Seite 243

Tamara flächenbündig



Seite 243



Melissa
FLÄCHENBÜNDIG

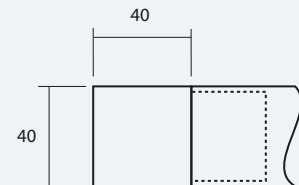

Tamara
FLÄCHENBÜNDIG

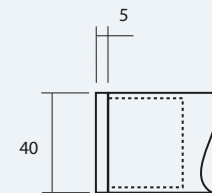



Endknöpfe Oval 40x22mm

Melissa

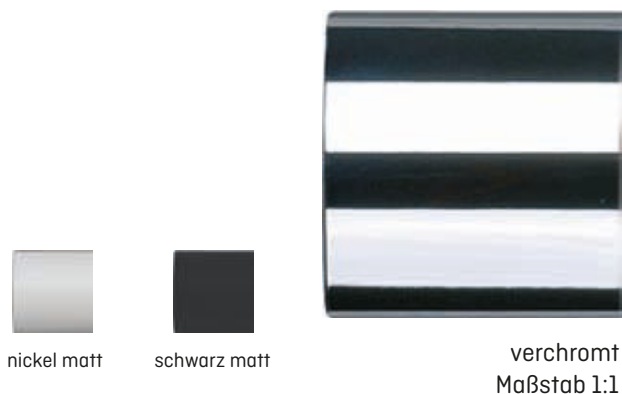
FLÄCHENBÜNDIG





Endknopf Melissa		Stück
nickel matt	 830 117 n	44,40
verchromt	 830 117 v	44,40
schwarz matt	 830 117 sm	38,40

Tamara

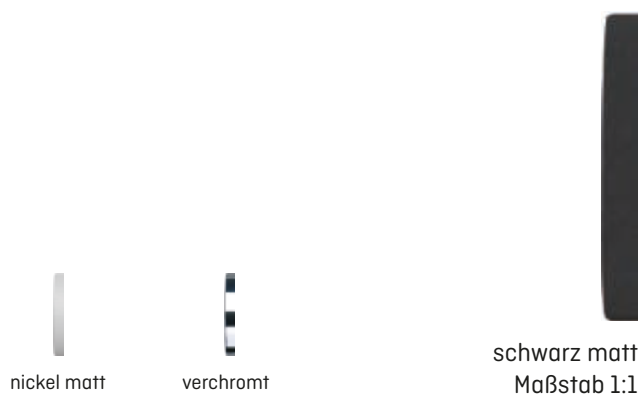
FLÄCHENBÜNDIG



Endknopf Tamara		Stück
nickel matt	 830 119-4 n	36,-
verchromt	 830 119-4 v	36,-
schwarz matt	 830 119-4 sm	30,-



PROFIL 40-70

Oval
40x22mm

Profil
40-70



mit KLIXI
Drehgleiter

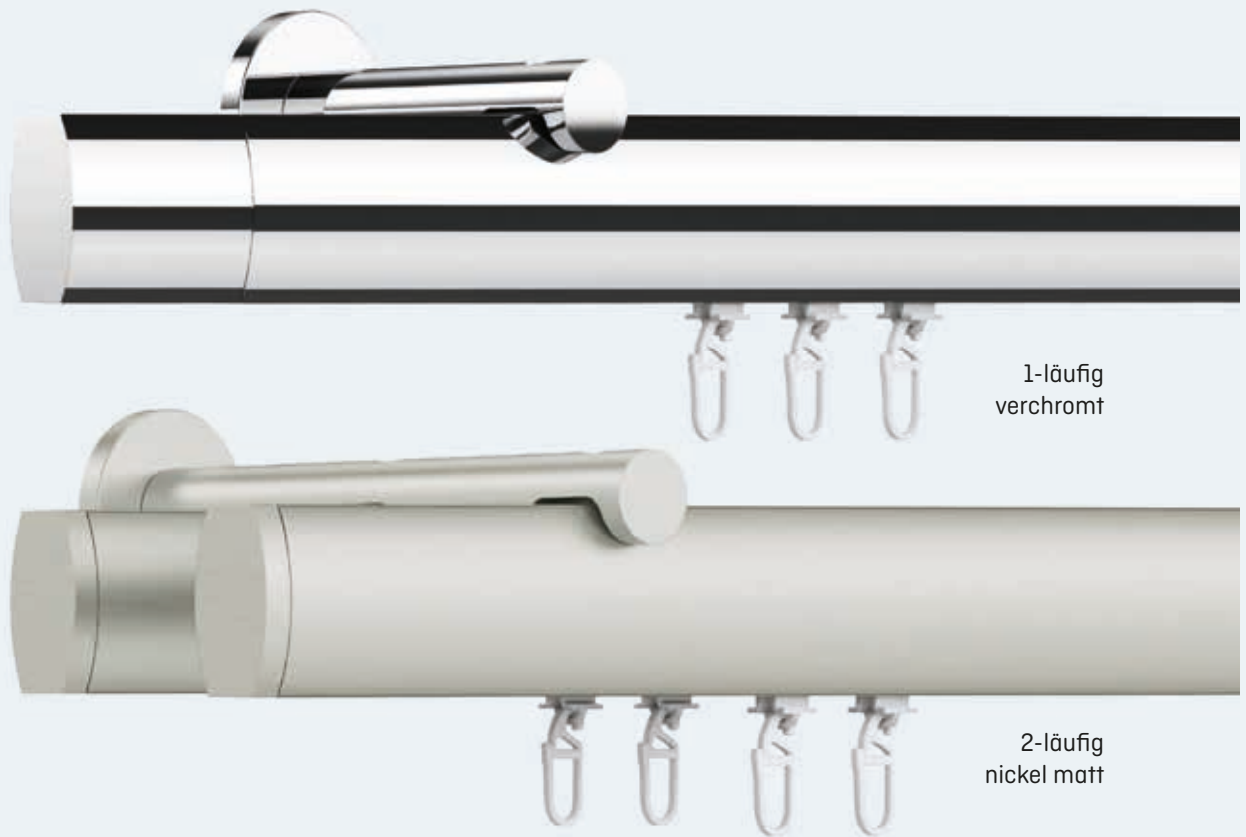

Farben Zubehör & Stangen



nickel matt



verchromt



schwarz matt

Oval 40x22mm

Garnituren mit Wandträgern
ohne Endknöpfe



verchromt
1-läufig
Maßstab 1:1





nickel matt, 2-läufig
Maßstab 1:1









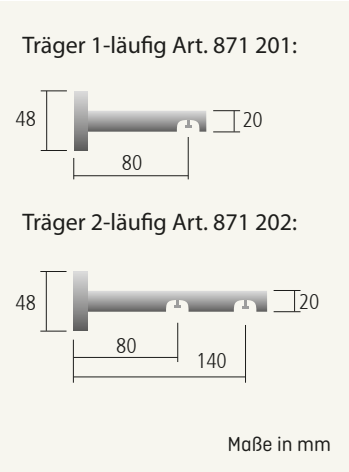

verchromt
Profil schwarz matt
1-läufig
Maßstab 1:1

Lieferumfang

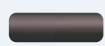
- ▶ **1 lfg:** 1 Alu Innenlauf-Profil 40x22mm oberflächenbehandelt, je nach Länge Wandträger und -Drehgleiter lt. Liste
 - ▶ **2 lfg:** 2 Alu Innenlauf-Profile 40x22mm oberflächenbehandelt, je nach Länge Wandträger und -Drehgleiter lt. Liste, 2 Endkappen
- ▶ mit Montagematerial
 - ▶ Bestellmaß = Profilmaß
 - ▶ Trägermitte bis Innenlauf-Profilunterkante: 39mm
 - ▶ bei geänderter Ausführung Aufpreis bzw. Preisänderung
 - ▶ **Aus produktionstechnischen Gründen bestehen geringfügige Farbabweichungen zwischen den Karniesenkomponenten.**

Trägermaße



			 nickel matt		 verchromt		 schwarz matt	
Bestellcode:			t40-103	t40-104	t40-105	t40-106	t40-107	t40-108
Länge (cm)	Wand-träger	Gleiter 1l./2l.	1lfg 	2lfg 	1lfg 	2lfg 	1lfg 	2lfg 
100	2	16/32	176	339	217	422	156	293
120	2	18/36	189	365	238	464	166	314
140	2	22/44	202	391	259	506	176	335
160	2	26/52	215	417	280	548	186	356
180	2	28/54	228	443	301	590	196	377
200	2	32/64	241	469	322	632	206	398
220	2	34/68	254	495	343	674	216	419
240	3	38/76	322	591	421	788	280	503
260	3	42/84	335	617	442	830	290	524
280	3	44/88	348	643	463	872	300	545
300	3	48/96	361	669	484	914	310	566
320	3	50/100	374	695	505	956	320	587
340	3	54/108	387	721	526	998	330	608
360	3	58/116	400	747	547	1.040	340	629
380	3	60/120	413	773	568	1.082	350	650
400	3	64/128	426	799	589	1.124	360	671
+ 20cm	▲	3/6	13	26	21	42	10	21

▲ ab einer Länge von ca. 420 cm bzw. bei schwereren Vorhängen wird ein weiterer Träger empfohlen (Aufpreis)

Träger kürzen: 19,-/Stück

Träger 1-läufig:  kürzbar um max. 30 mm

Träger 2-läufig:  kürzbar um max. 30 mm

Garnituren mit Multi-Wandträgern ohne Endknöpfe

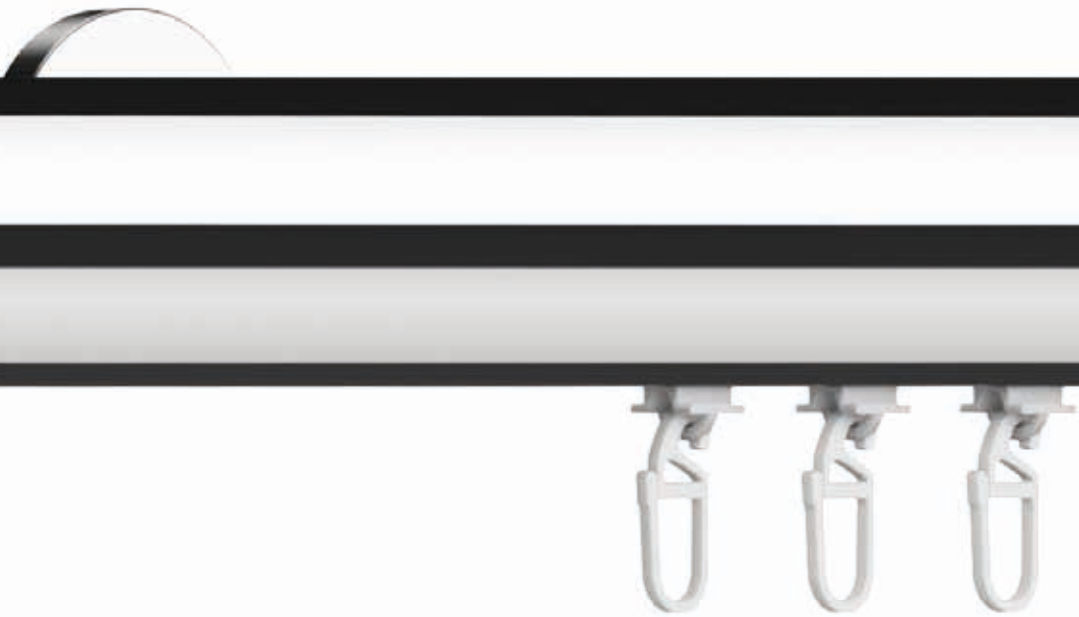

verchromt
1-läufig
Maßstab 1:1

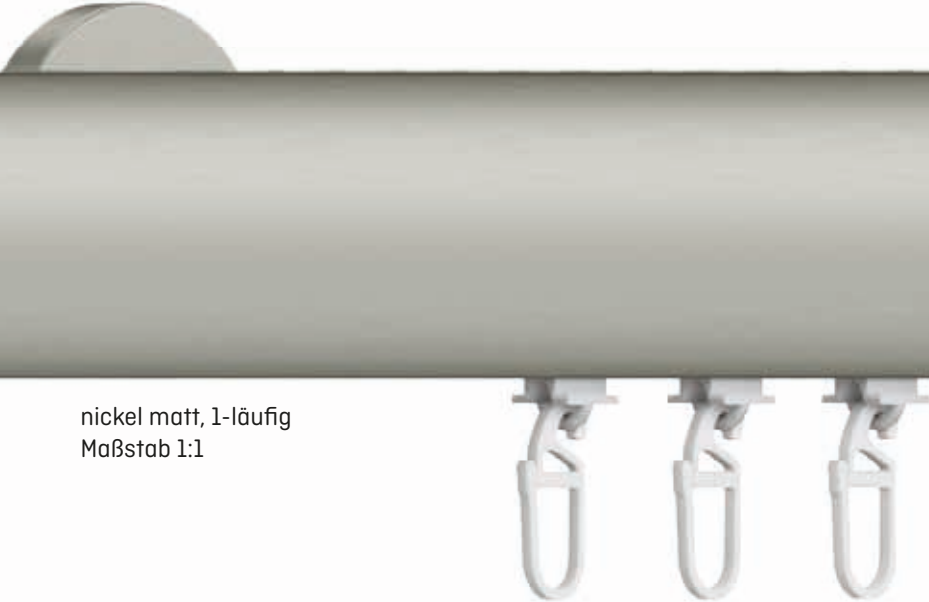

nickel matt, 1-läufig
Maßstab 1:1



verchromt
Profil schwarz matt
1-läufig
Maßstab 1:1

Lieferumfang

- ▶ **1 lfg:** 1 Alu Innenlauf-Profil 40x22mm oberflächenbehandelt, je nach Länge Wandträger und FLIX-Drehgleiter lt. Liste
 - ▶ **2-/3-lfg:** 1 Alu Innenlauf-Profil 40x22mm oberflächenbehandelt, 1 bzw. 2 Alu Innenlauf-Profile Ø20mm oberflächenbehandelt, je nach Länge Wandträger und FLIX-Drehgleiter lt. Liste, 2 Endkappen 831 420 Ø20mm je Lauf
- ▶ mit Montagematerial
 - ▶ Bestellmaß = Profilmaß
 - ▶ Trägermitte bis Innenlauf-Profilunterkante 40x22: 27mm
 - ▶ Trägermitte bis Innenlauf-Profilunterkante Ø20mm: 26mm
 - ▶ bei geänderter Ausführung Aufpreis bzw. Preisänderung
 - ▶ **Aus produktionstechnischen Gründen bestehen geringfügige Farbabweichungen zwischen den Karniesenkomponenten.**

Trägermaße

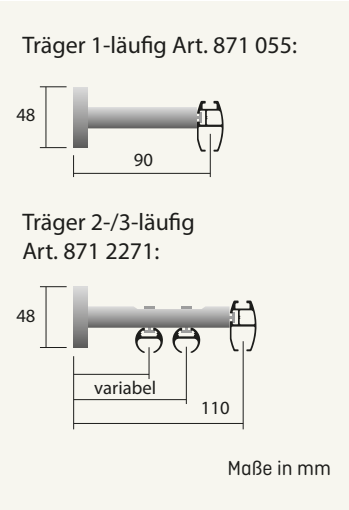

Profil
40-70

				nickel matt			verchromt			schwarz matt		
Bestellcode:				t40-134	t40-135	t40-136	t40-137	t40-138	t40-139	t40-140	t40-141	t40-142
Länge (cm)	Wandträger		Gleiter pro Lauf	1lfg	2lfg	3lfg	1lfg	2lfg	3lfg	1lfg	2lfg	3lfg
	871 055	871 2271										
100	2	2	16	168	312	413	210	353	454	141	256	337
120	2	2	18	181	335	446	231	384	495	151	274	362
140	2	2	22	194	358	479	252	415	536	161	292	387
160	2	2	26	207	381	512	273	446	577	171	310	412
180	2	2	28	220	404	545	294	477	618	181	328	437
200	2	2	32	233	427	578	315	508	659	191	346	462
220	2	3	34	246	522	683	336	613	774	201	423	548
240	3	3	38	311	545	716	410	644	815	259	441	573
260	3	3	42	324	568	749	431	675	856	269	459	598
280	3	3	44	337	591	782	452	706	897	279	477	623
300	3	3	48	350	614	815	473	737	938	289	495	648
320	3	3	50	363	637	848	494	768	979	299	513	673
340	3	3	54	376	660	881	515	799	1.020	309	531	698
360	3	3	58	389	683	914	536	830	1.061	319	549	723
380	3	3	60	402	706	947	557	861	1.102	329	567	748
400	3	4	64	415	801	1.052	578	966	1.216	339	643	834
+ 20cm ▲			3	13	23	33	21	31	41	10	18	25

- ▲ Träger 871055: ab einer Länge von 420 cm bzw. bei schwereren Vorhängen wird ein weiterer Träger empfohlen
- ▲ Träger 8712271: ab einer Länge von 580 cm bzw. bei schwereren Vorhängen wird ein weiterer Träger empfohlen

Garnituren mit Deckenträgern ohne Endknöpfe



verchromt
mit Deckenträger
871 2091
Maßstab 1:1





nickel matt
mit Deckenträger 871 077
Maßstab 1:1



nickel matt
mit Deckenträger 871 2091
Profil schwarz matt
Maßstab 1:1

Lieferumfang

- ▶ **1 lfg mit Deckenträger 6mm Deckenabstand:**
1 Alu Innenlauf-Profil 40x22mm oberflächenbehandelt, je nach Länge Deckenträger und -Drehgleiter lt. Liste
 - ▶ **1 lfg mit Deckenträger 35mm Deckenabstand:**
1 Alu Innenlauf-Profil 40x22mm oberflächenbehandelt, je nach Länge Deckenträger und -Drehgleiter lt. Liste
 - ▶ **2 lfg mit Deckenträger 53mm Deckenabstand:**
2 Alu Innenlauf-Profile 40x22mm oberflächenbehandelt, je nach Länge Deckenträger und -Drehgleiter lt. Liste, 2 Endkappen
- ▶ mit Montagematerial
 - ▶ Bestellmaß = Profilmaß
 - ▶ Decke bis Innenlauf-Profilunterkante: siehe Maßskizzen rechts
 - ▶ bei geänderter Ausführung Aufpreis bzw. Preisänderung
 - ▶ **Aus produktionstechnischen Gründen bestehen geringfügige Farbabweichungen zwischen den Karniesenkomponenten.**

Trägermaße

Träger 1-läufig Art. 871 2091
Deckenabstand 6mm:

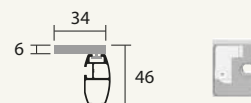



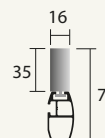



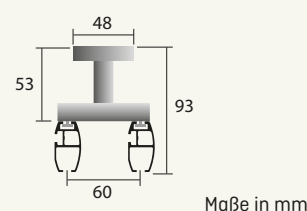



Träger 1-läufig Art. 871 077
Deckenabstand 35mm:



Träger 2-läufig Art. 871 153
Deckenabstand 53mm:



			 nickel matt			 verchromt			 schwarz matt	
Bestellcode:			t40-164	t40-165	t40-166	t40-167	t40-168	t40-169	t40-170	t40-171
Länge (cm)	Wand-träger	Gleiter 1l./2l.	1lfg 	1lfg 	2lfg 	1lfg 	1lfg 	2lfg 	1lfg 	1lfg 
100	2	16/32	131	126	360	172	167	443	108	108
120	2	18/36	144	139	386	193	188	485	118	119
140	2	22/44	157	152	412	214	209	527	128	130
160	2	26/52	170	165	438	235	230	569	138	141
180	2	28/54	183	178	464	256	251	611	148	152
200	2	32/64	196	191	490	277	272	653	158	163
220	2	34/68	209	204	516	298	293	695	168	174
240	3	38/76	254	247	622	353	346	819	209	214
260	3	42/84	267	260	648	374	367	861	219	225
280	3	44/88	280	273	674	395	388	903	229	236
300	3	48/96	293	286	700	416	409	945	239	247
320	3	50/100	306	299	726	437	430	987	249	258
340	3	54/108	319	312	752	458	451	1.029	259	269
360	3	58/116	332	325	778	479	472	1.071	269	280
380	3	60/120	345	338	804	500	493	1.113	279	291
400	3	64/128	358	351	830	521	514	1.155	289	302
+ 20cm	▲	3/6	13	13	26	21	21	42	10	11

▲ ab einer Länge von ca. 420 cm bzw. bei schwereren Vorhängen wird ein weiterer Träger empfohlen (Aufpreis)

Zubehör/Einzelteile Oval 40x22mm siehe Seite 260





PROFIL 40-70

Oval
70x22mm

Profil
40-70

 mit KLIXI
Drehgleiter



Farben Zubehör



nickel matt

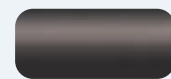

schwarz matt

Farben Stangen



nickel matt



schwarz matt

Oval 70x22mm

Komplettgarnituren mit Wandträgern inkl. Endkappen



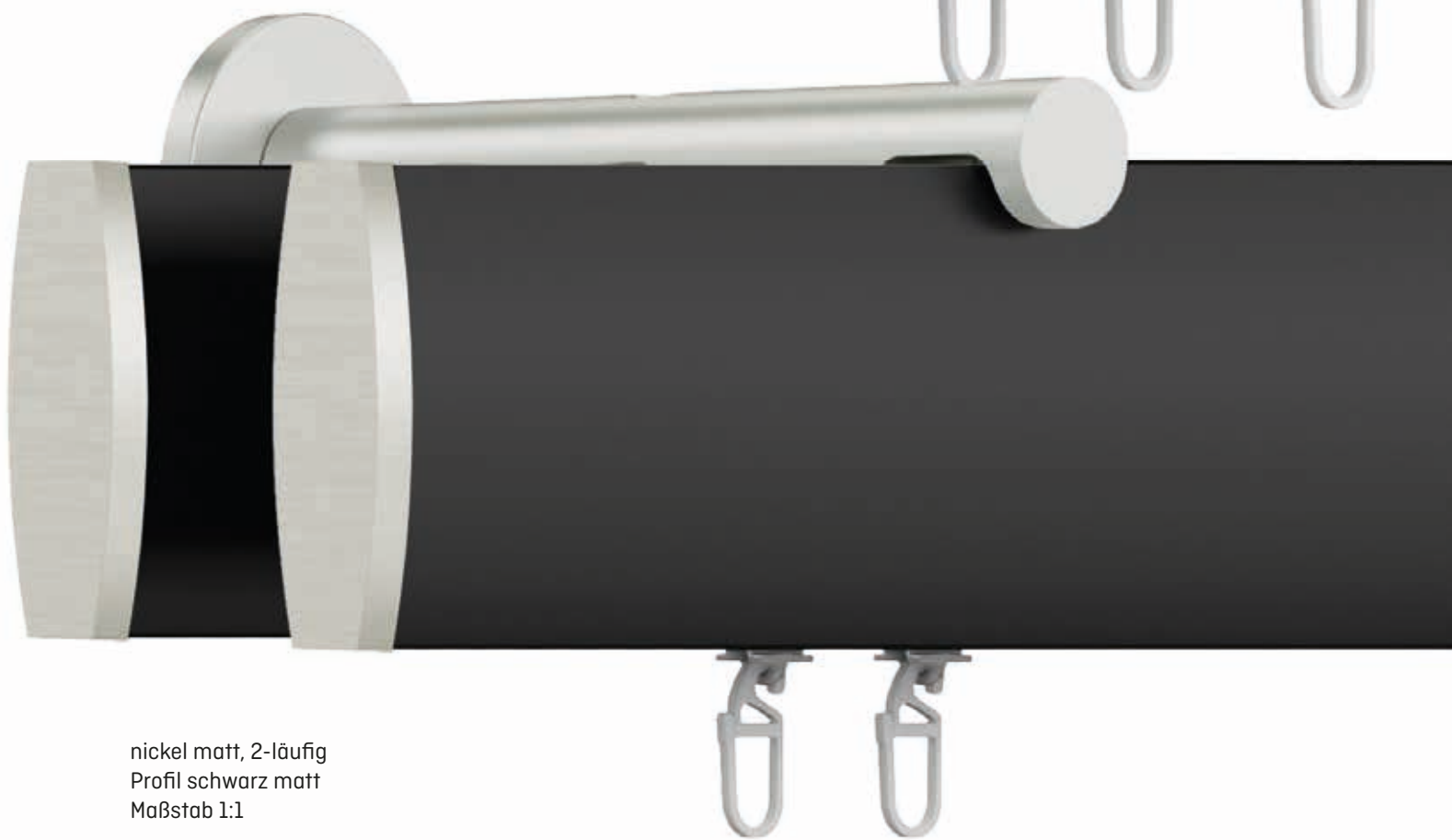

nickel matt, 1-läufig
Maßstab 1:1



nickel matt, 2-läufig
Profil schwarz matt
Maßstab 1:1

Lieferumfang

- ▶ **1 lfg:** 1 Alu Innenlauf-Profil 70x22mm oberflächenbehandelt, je nach Länge Wandträger und -Drehgleiter lt. Liste, 2 Endkappen
- ▶ **2 lfg:** 2 Alu Innenlauf-Profile 70x22mm oberflächenbehandelt, je nach Länge Wandträger und -Drehgleiter lt. Liste, 4 Endkappen

- ▶ mit Montagematerial
- ▶ Bestellmaß = Profilmaß
- ▶ Trägermitte bis Innenlauf-Profilunterkante: 69mm
- ▶ bei geänderter Ausführung Aufpreis bzw. Preisänderung
- ▶ **Aus produktionstechnischen Gründen bestehen geringfügige Farbabweichungen zwischen den Karniesenkomponenten.**

Trägermaße



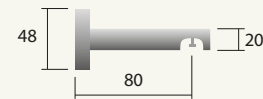

Träger 1-läufig Art. 871 201:

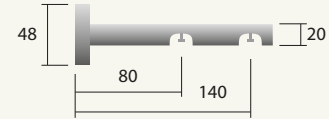

Träger 2-läufig Art. 871 202:

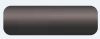

Maße in mm

			 nickel matt		 schwarz matt	
Bestellcode:			t70-103	t70-104	t70-107	t70-108
Länge (cm)	Wand-träger	Gleiter 1l./2l.	1lfg 	2lfg 	1lfg 	2lfg 
100	2	16/32	280	478	246	414
120	2	18/36	296	509	258	439
140	2	22/44	312	540	270	464
160	2	26/52	328	571	282	489
180	2	28/54	344	602	294	514
200	2	32/64	360	633	306	539
220	2	34/68	376	664	318	564
240	2	38/76	392	695	330	589
260	2	42/84	408	726	342	614
280	3	44/88	475	828	410	703
300	3	48/96	491	859	422	728
320	3	50/100	507	890	434	753
340	3	54/108	523	921	446	778
360	3	58/116	539	952	458	803
380	3	60/120	555	983	470	828
400	3	64/128	571	1.014	482	853
+ 20cm	▲	3/6	16	31	12	25

▲ ab einer Länge von ca. 520 cm bzw. bei schwereren Vorhängen wird ein weiterer Träger empfohlen (Aufpreis)

Träger kürzen: 19,-/Stück

Träger 1-läufig:

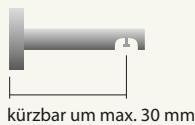

Träger 2-läufig:

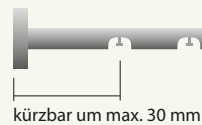

Komplettgarnituren mit Multi-Wandträgern
inkl. Endkappen

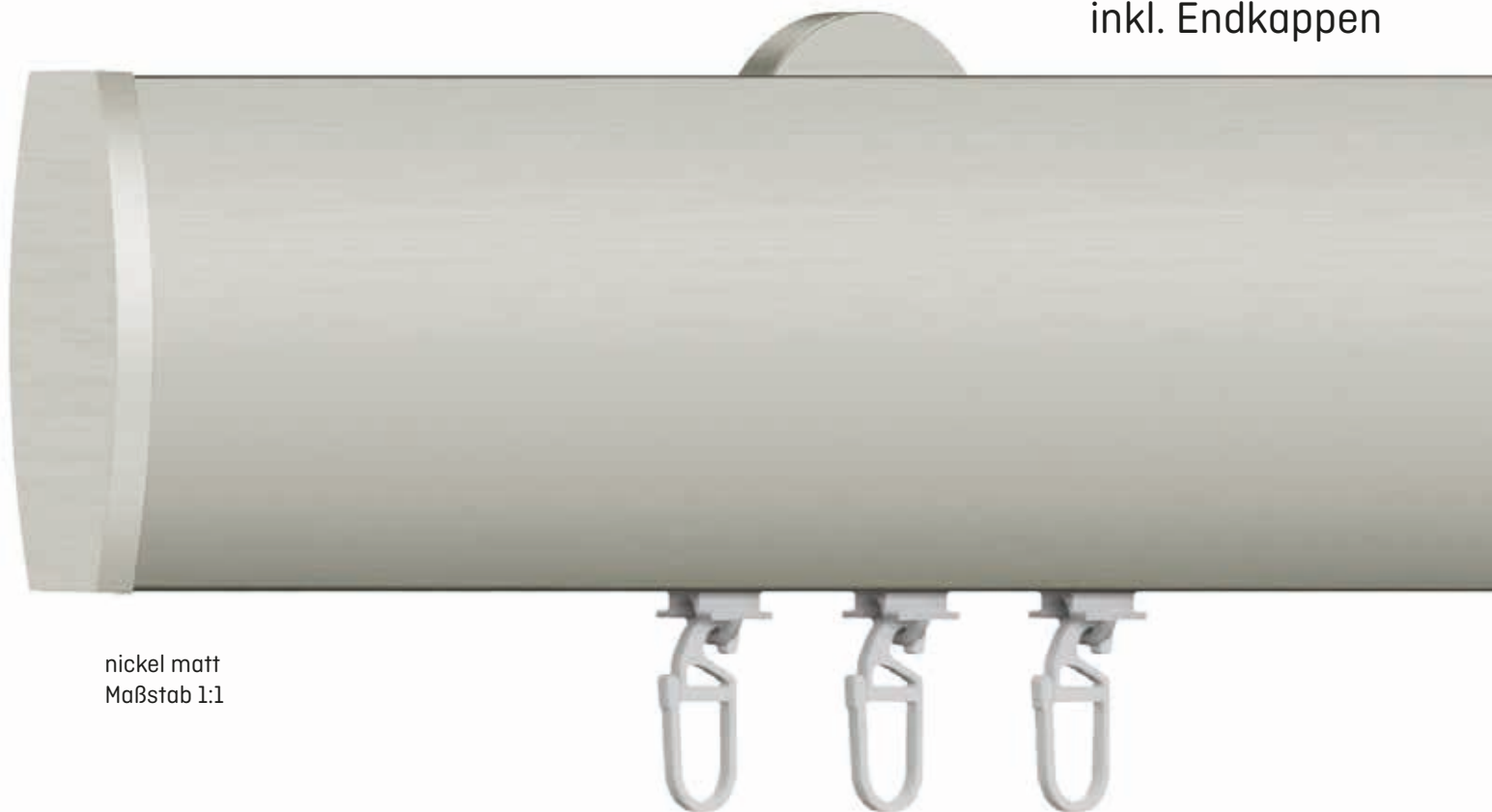



nickel matt
Maßstab 1:1









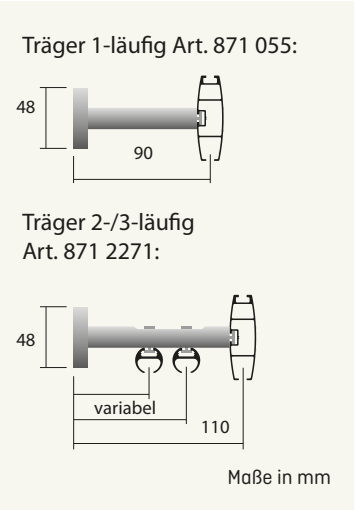

nickel matt
Profil schwarz matt
Maßstab 1:1

Lieferumfang

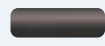
- ▶ **1 lfg:** 1 Alu Innenlauf-Profil 70x22mm oberflächenbehandelt, inkl. 2 Endkappen, je nach Länge Wandträger und -Drehgleiter lt. Liste
 - ▶ **2-/3-lfg:** 1 Alu Innenlauf-Profil 70x22mm oberflächenbehandelt, inkl. 2 Endkappen, 1 bzw. 2 Alu Innenlauf-Profile Ø20mm oberflächenbehandelt, je nach Länge Wandträger und -Drehgleiter lt. Liste, 2 Endkappen je Schienenlauf
- ▶ mit Montagematerial
 - ▶ Bestellmaß = Profilmaß
 - ▶ Trägermitte bis Innenlauf-Profilunterkante 70x22: 35mm
 - ▶ Trägermitte bis Innenlauf-Profilunterkante Ø20mm: 26mm
 - ▶ bei geänderter Ausführung Aufpreis bzw. Preisänderung
 - ▶ **Aus produktionstechnischen Gründen bestehen geringfügige Farbabweichungen zwischen den Karniesenkomponenten.**

Trägermaße



				 nickel matt			 schwarz matt		
Bestellcode:				t70-134	t70-135	t70-136	t70-140	t70-141	t70-142
Länge (cm)	Wand-träger		Gleiter pro Lauf	1lfg 	2lfg 	3lfg 	1lfg 	2lfg 	3lfg 
	871 055	871 2271							
100	2	2	16	273	417	518	232	346	427
120	2	2	18	289	442	553	244	366	454
140	2	2	22	305	467	588	256	386	481
160	2	2	26	321	492	623	268	406	508
180	2	2	28	337	517	658	280	426	535
200	2	2	32	353	542	693	292	446	562
220	2	3	34	369	642	803	304	526	650
240	2	3	38	385	667	838	316	546	677
260	2	3	42	401	692	873	328	566	704
280	3	3	44	465	717	908	388	586	731
300	3	3	48	481	742	943	400	606	758
320	3	3	50	497	767	978	412	626	785
340	3	3	54	513	792	1.013	424	646	812
360	3	3	58	529	817	1.048	436	666	839
380	3	3	60	545	842	1.083	448	686	866
400	3	4	64	561	945	1.195	460	764	955
+ 20cm ▲			3	16	25	35	12	20	27

- ▲ Träger 871055: ab einer Länge von 520 cm bzw. bei schwereren Vorhängen wird ein weiterer Träger empfohlen
- ▲ Träger 8712271: ab einer Länge von 580 cm bzw. bei schwereren Vorhängen wird ein weiterer Träger empfohlen

Komplettgarnituren mit Deckenträgern
inkl. Endkappen

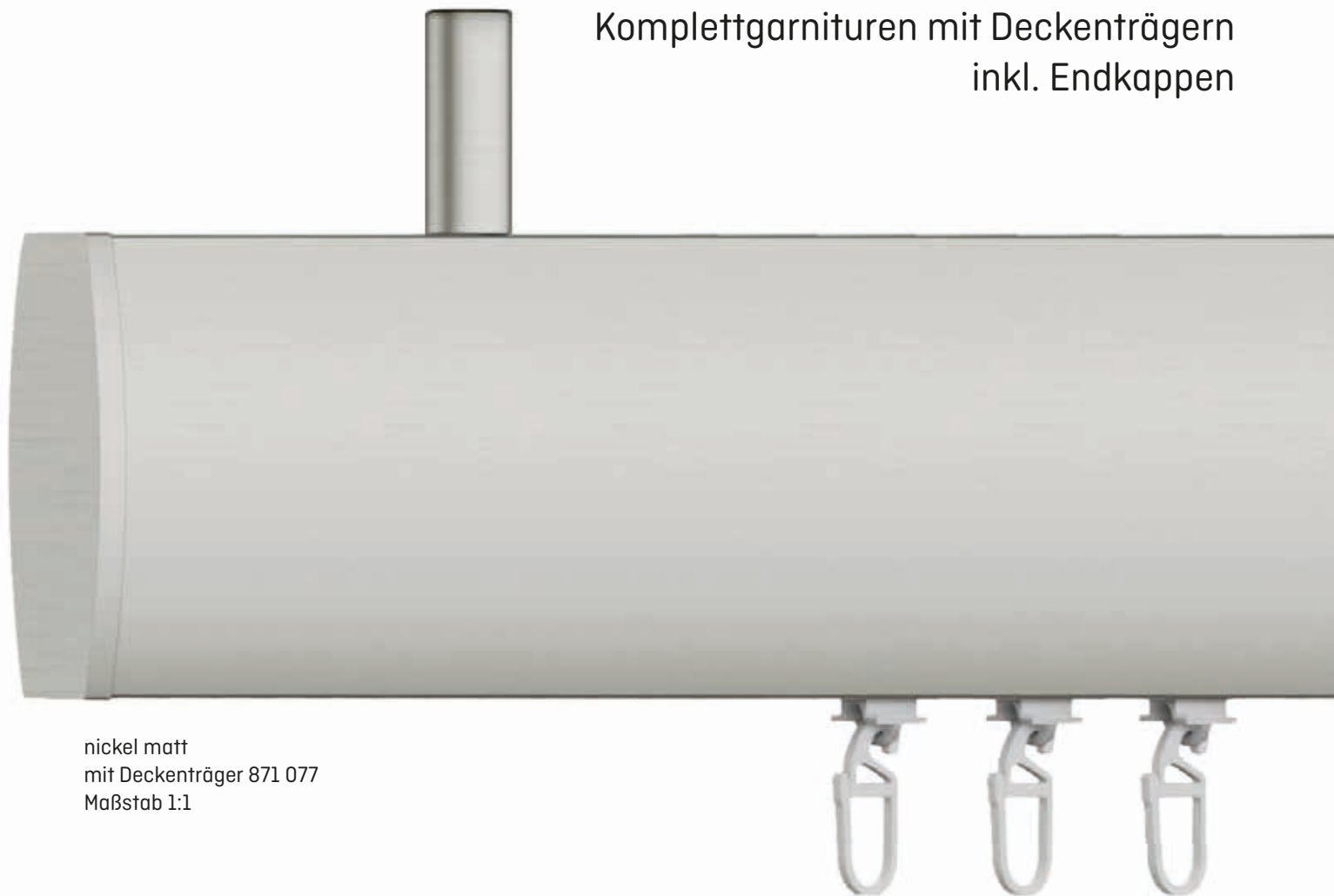

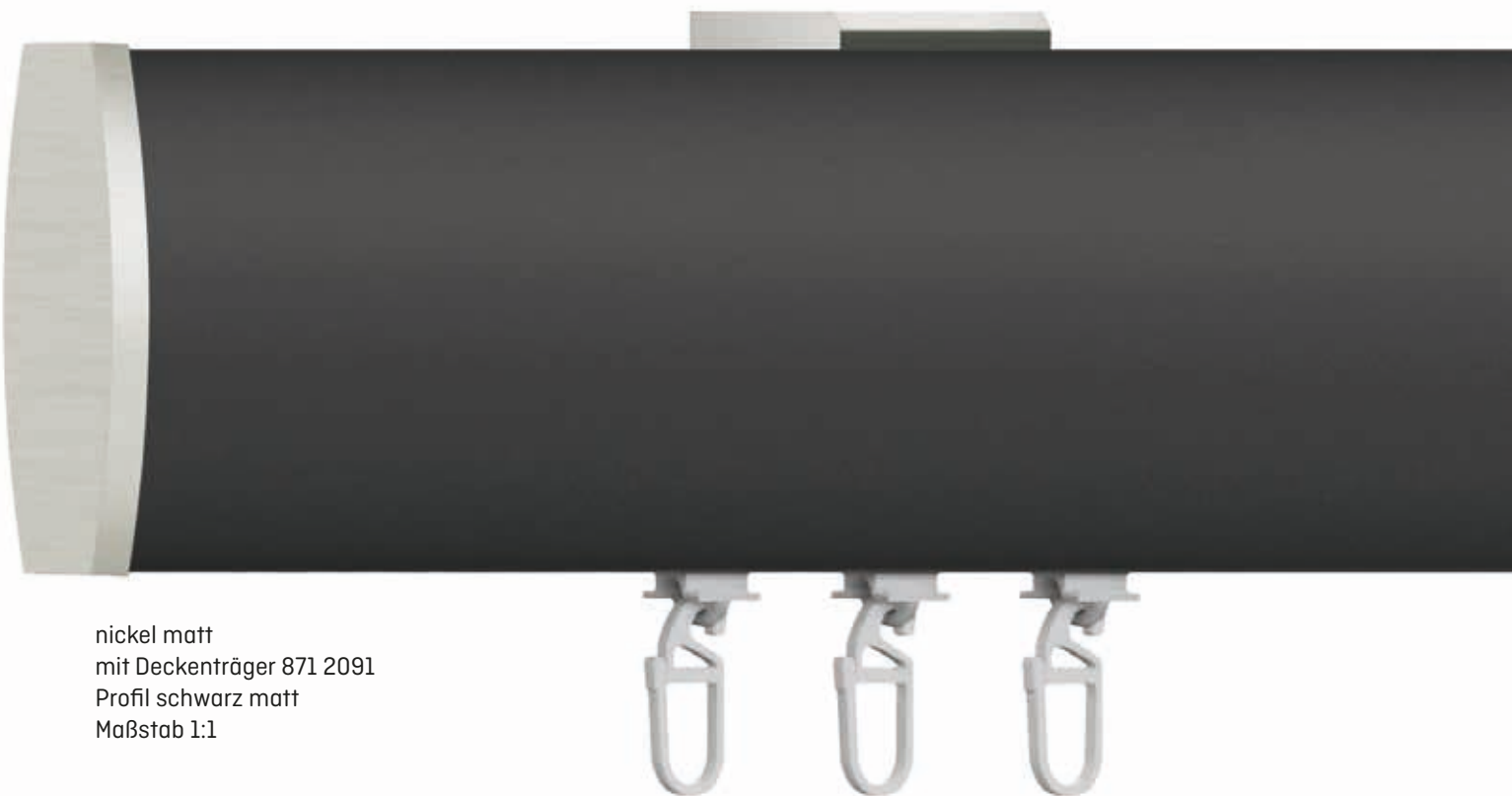

nickel matt
mit Deckenträger 871 077
Maßstab 1:1



nickel matt
mit Deckenträger 871 2091
Profil schwarz matt
Maßstab 1:1

Lieferumfang

- ▶ **1 lfg mit Deckenträger 6mm Deckenabstand:**
1 Alu Innenlauf-Profil 70x22mm oberflächenbehandelt, je nach Länge Deckenträger und -Drehgleiter lt. Liste, 2 Endkappen
 - ▶ **1 lfg mit Deckenträger 35mm Deckenabstand:**
1 Alu Innenlauf-Profil 70x22mm oberflächenbehandelt, je nach Länge Deckenträger und -Drehgleiter lt. Liste, 2 Endkappen
 - ▶ **2 lfg mit Deckenträger 53mm Deckenabstand:**
2 Alu Innenlauf-Profile 70x22mm oberflächenbehandelt, je nach Länge Deckenträger und -Drehgleiter lt. Liste, 4 Endkappen
- ▶ mit Montagematerial
 - ▶ Bestellmaß = Profilmaß
 - ▶ Decke bis Innenlauf-Profilunterkante: siehe Maßskizzen rechts
 - ▶ bei geänderter Ausführung Aufpreis bzw. Preisänderung
 - ▶ **Aus produktionstechnischen Gründen bestehen geringfügige Farbabweichungen zwischen den Karniesenkomponenten.**

Trägermaße

Träger 1-läufig Art. 871 2091
Deckenabstand 6mm:

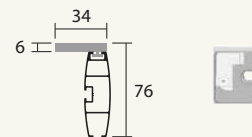



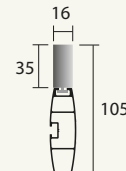

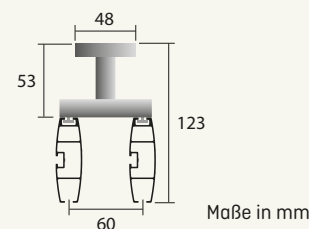

Träger 1-läufig Art. 871 077
Deckenabstand 35mm:





Träger 2-läufig Art. 871 153
Deckenabstand 53mm:





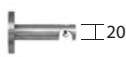

Maße in mm

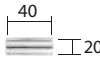
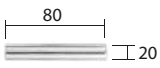

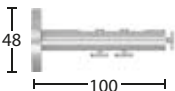
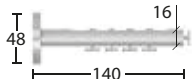

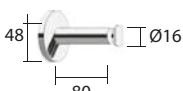
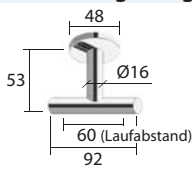
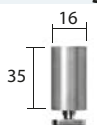
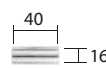
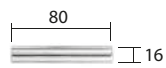
			 nickel matt			 schwarz matt	
Bestellcode:			t70-164	t70-165	t70-166	t70-170	t70-171
Länge (cm)	Wand-träger	Gleiter 1l./2l.	1lfg 	1lfg 	2lfg 	1lfg 	1lfg 
100	2	16/32	235	231	499	199	189
120	2	18/36	251	247	530	211	201
140	2	22/44	267	263	561	223	213
160	2	26/52	283	279	592	235	225
180	2	28/54	299	295	623	247	237
200	2	32/64	315	311	654	259	249
220	2	34/68	331	327	685	271	261
240	2	38/76	347	343	716	283	273
260	2	42/84	363	359	747	295	285
280	3	44/88	408	401	859	339	325
300	3	48/96	424	417	890	351	337
320	3	50/100	440	433	921	363	349
340	3	54/108	456	449	952	375	361
360	3	58/116	472	465	983	387	373
380	3	60/120	488	481	1.014	399	385
400	3	64/128	504	497	1.045	411	397
+ 20cm	▲	3/6	16	16	31	12	12

▲ ab einer Länge von ca. 520 cm bzw. bei schwereren Vorhängen wird ein weiterer Träger empfohlen (Aufpreis)

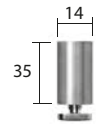
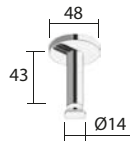
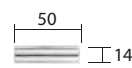
Träger und passende Verlängerungen			
Wandträger 1lfg., Wandabstand 80mm			
	nickel matt	871 201 n	56,40
	verchromt	871 201 v	56,40
	schwarz matt	871 201 sm	52,80
Wandträger 2lfg., Wandabstand 80/140mm			
	nickel matt	871 202 n	70,80
	verchromt	871 202 v	70,80
	schwarz matt	871 202 sm	66,-
Trägerverlängerung 40mm			
	nickel matt	871 040 n	25,20
	verchromt	871 040 v	25,20
	schwarz matt	871 040 sm	24,-
Trägerverlängerung 80mm			
	nickel matt	871 060 n	30,-
	verchromt	871 060 v	30,-
	schwarz matt	871 060 sm	28,80

Träger und passende Verlängerungen			
Multi-Wandträger 1-3lfg., Wandabstand 100mm			
	nickel matt	871 2271 n	74,40
	verchromt	871 2271 v	74,40
	schwarz matt	871 2271 sm	62,40
Multi-Wandträger 1-5lfg., Wandabstand 140mm			
	nickel matt	871 2272 n	81,60
	verchromt	871 2272 v	81,60
	schwarz matt	871 2272 sm	69,60
Wand-/Deckenträger 1lfg., Wandabstand 43mm			
	nickel matt	871 053 n	50,40
	verchromt	871 053 v	50,40
Wand-/Deckenträger 1lfg., Wandabstand 80mm			
	nickel matt	871 055 n	52,80
	verchromt	871 055 v	52,80
	schwarz matt	871 055 sm	45,60
Deckenträger 2lfg., Deckenabstand 53mm/Ø16mm			
	nickel matt	871 153 n	81,60
	verchromt	871 153 v	81,60
Deckenträger, Deckenabstand 35mm/Ø16mm			
	nickel matt	871 077 n	31,20
	verchromt	871 077 v	31,20
Trägerverlängerung für Wand-/Deckenträger, 40mm			
	nickel matt	871 044 n	21,60
	verchromt	871 044 v	21,60
	schwarz matt	871 044 sm	21,60
Trägerverlängerung für Wand-/Deckenträger, 80mm			
	nickel matt	871 066 n	24,-
	verchromt	871 066 v	24,-
	schwarz matt	871 066 sm	24,-

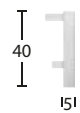
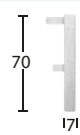
Träger und passende Verlängerungen			
Deckenträger, Deckenabstand 15mm			
	nickel matt	871 076 n	25,20
	verchromt	871 076 v	25,20
	schwarz matt	871 076 sm	25,50
Deckenträger, Deckenabstand 35mm/Ø14mm			
	schwarz matt	871 077 sm	24,-
Deckenträger 1lfg., Deckenabstand 43mm/Ø14mm			
	schwarz matt	871 053 sm	34,80
Trägerverlängerung 50mm			
	schwarz matt	810 735 sm	16,80

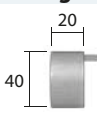
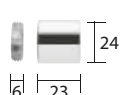
Deckenträger kürzbar - Deckenabstand 42-500mm			
	schwarz matt	871 084 sm	57,60
Deckenträger 1lfg., Deckenabstand 6mm			
	nickel matt	871 2091 n	33,60
	verchromt	871 2091 v	33,60
	schwarz matt	871 2091 sm	28,80
Endkappe flächenbündig für Oval 40x22mm			
	nickel matt	830 119-4 n	36,-
	verchromt	830 119-4 v	36,-
	schwarz matt	830 119-4 sm	30,-
Endkappe flächenbündig für Oval 70x22mm			
	nickel matt	830 119-7 n	46,80
	schwarz matt	830 119-7 sm	40,80
Endkappe flächenbündig Ø20mm			
	nickel matt	831 420 n	28,80
	verchromt	831 420 v	28,80
	schwarz matt	831 420 sm	22,80
Wandlager Oval für 40x22mm			
	nickel matt	82 340 n	52,80
	verchromt	82 340 v	52,80
	schwarz matt	82 340 sm	46,80
Wandlager Ø20mm			
	nickel matt	82 320 n	38,40
	verchromt	82 320 v	38,40
	schwarz matt	82 320 sm	33,60

Oval-Innenlauf-Profil 40x22mm, Stange 6m			Meter
	nickel matt	n90 640 n	69,-
	verchromt	n90 640 v	113,20
	schwarz matt	n90 640 sm	55,20

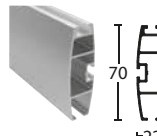
Oval-Innenlauf-Profil 70x22mm, Stange 6m			Meter
	nickel matt	n90 650 n	82,80
	schwarz matt	n90 650 sm	66,20

Alu Innenlauf-Profil Ø20mm, Stange 6m			Meter
	nickel matt	n90 620 n	63,50
	verchromt	n90 620 v	63,50
	schwarz matt	n90 620 sm	38,60

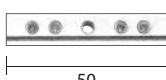
Profilverbinder Messing			Stück
	vernickelt	904 071	12,-

Profilverbinder Messing, beliebiger Winkel			Stück
	vernickelt	904 072 - bw	28,80

Gehrungsschnitt (ohne Profilverbinder)			Gehrung
	90°	1bg-1gs-90	20,-
	beliebiger Winkel	1bg-1gs-bw	49,-

KLIXI-Drehgleiter 100 Stück			Beutel
	Kunststoff grau	2400 100 g	12,-
	Kunststoff weiß	2400 100 w	12,-

Gleiter 100 Stück			Beutel
	Kunststoff weiß	3942 100	5,40

Ösengleiter 100 Stück			Beutel
	Kunststoff weiß	3910 100	9,90

Gardinen-Einfachhaken 100 Stück			Beutel
	Kunststoff weiß	601 100	6,50

Gardinen-Doppelhaken 100 Stück			Beutel
	Kunststoff weiß	605 100	11,-

Roller mit Faltenleghaken			Stück
	Kunststoff weiß	2420	0,20

Roller mit Kugellager nur für Profil n90640/n90650			Stück
	Kunststoff	904 074	1,10

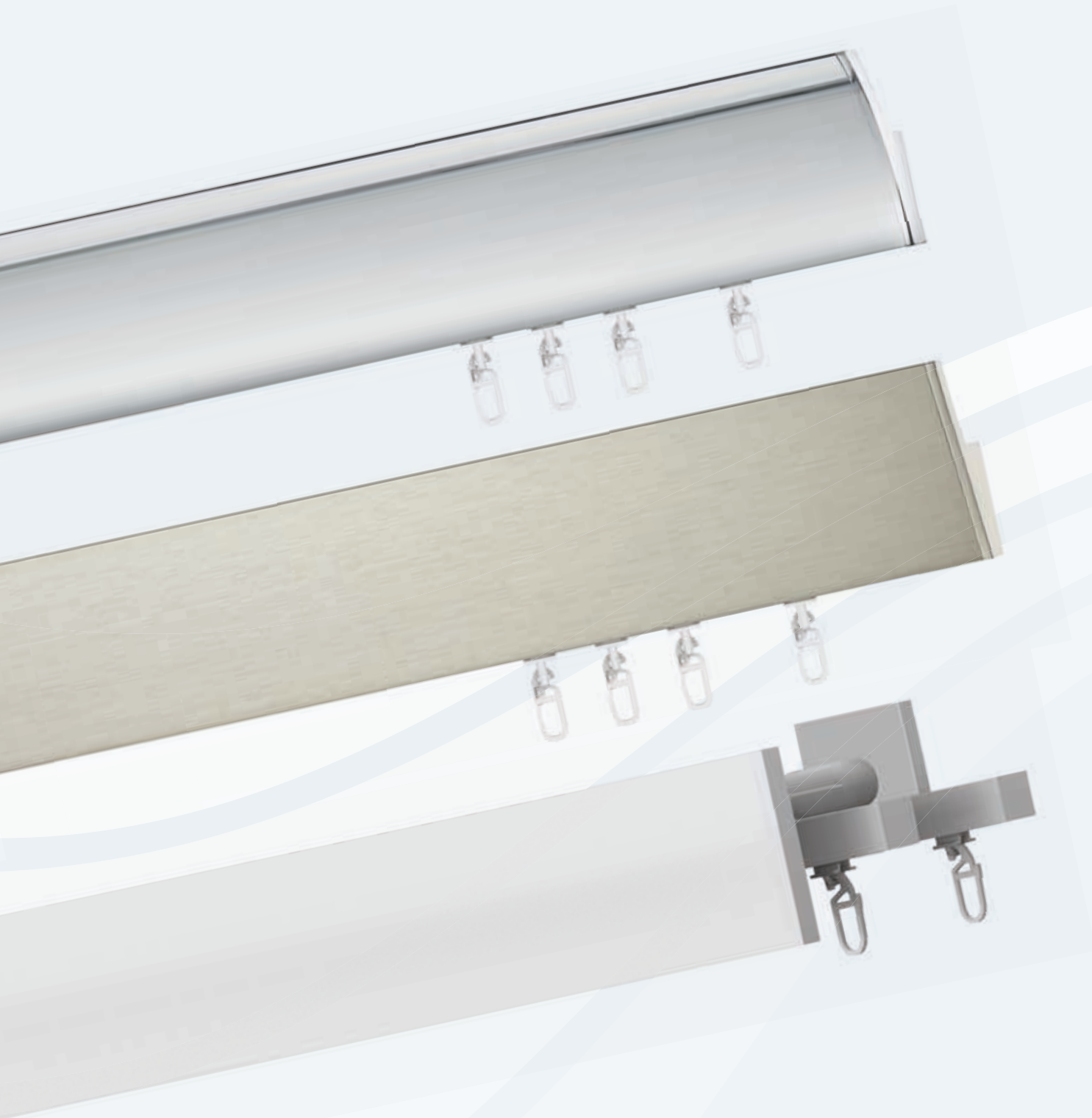

C-Profil/V-Profil/Blendsystem

C-Profil/V-Profil 70mm



C-Profil 70x57mm

Seite 263

Farben Stangen & Zubehör



V-Profil 70x57mm

Seite 267

Farben Stangen & Zubehör



Blendsystem Flach 60 mm

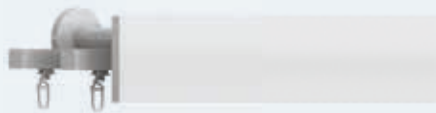

Multi-Wandträger

Seite 272

Farben Stangen & Zubehör

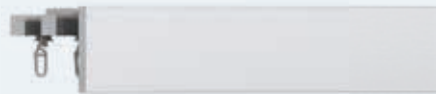

Deckenträger

Seite 274

Farben Stangen & Zubehör





PROFIL 40-70

C-Profil
70x57mm

Profil
40-70

 mit KLIXI
Drehgleiter

Erkerausführung nicht möglich!



Biegung



Gehrung



Gelenk

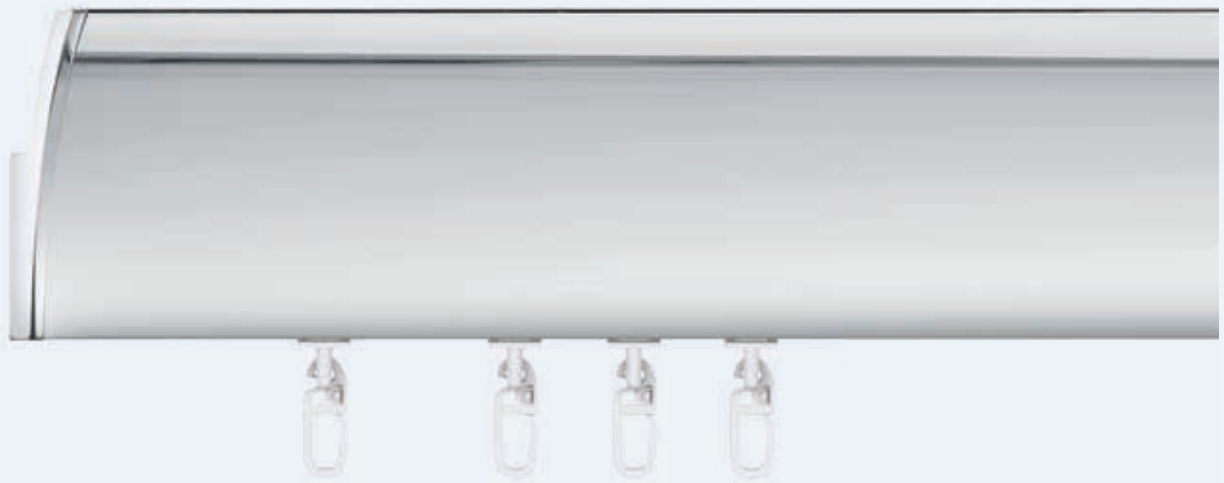

Farben Zubehör & Stangen



aluminium matt



nickel matt



verchromt



schwarz matt

C-Profil 70x57mm

Garnituren mit Multi-Wandträgern mit Endkappen

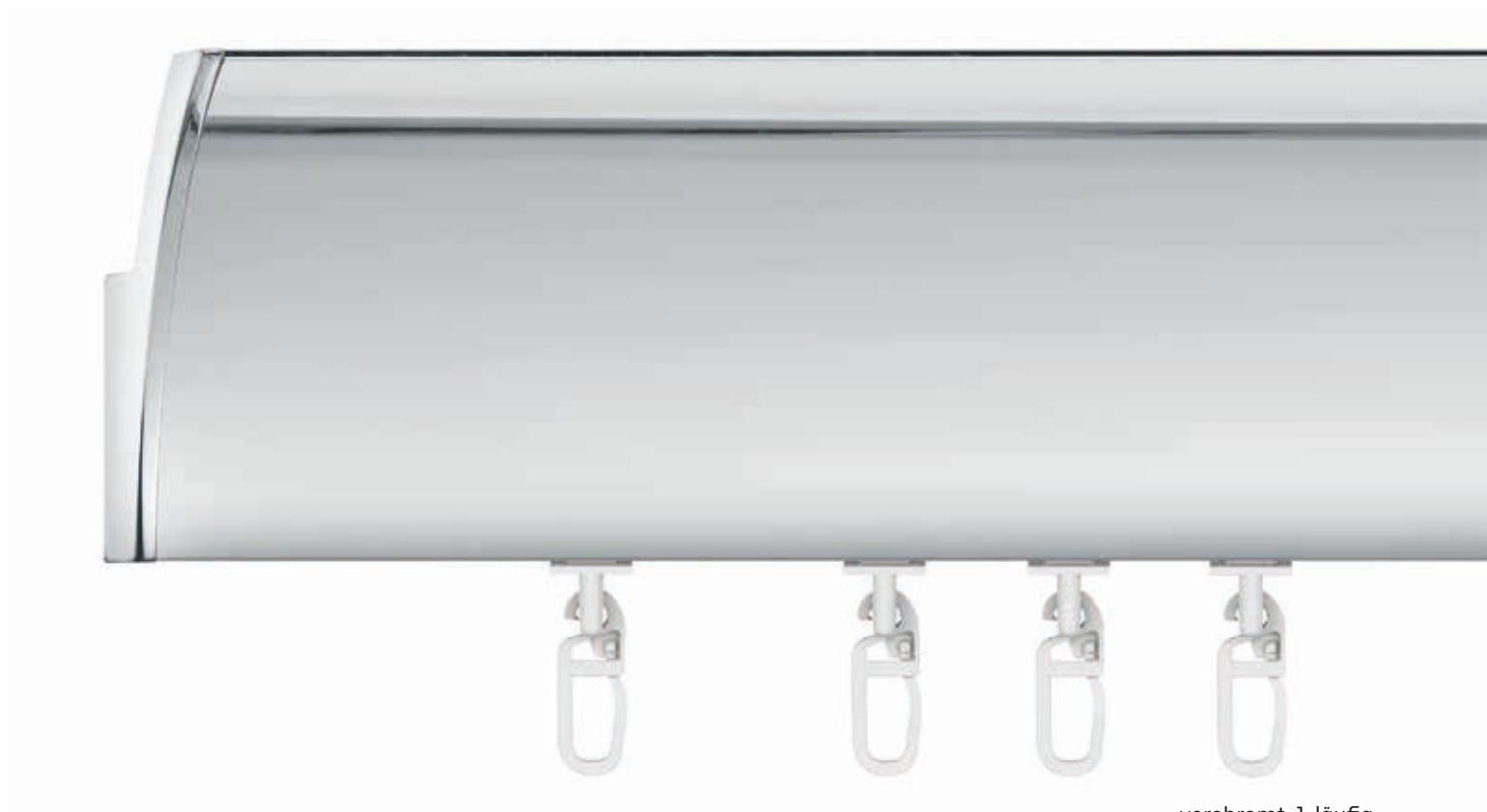



verchromt, 1-läufig
Maßstab 1:1



schwarz matt, 1-läufig
Maßstab 1:1

Lieferumfang

- ▶ **1 lfg:** 1 Alu Innenlauf-Profil 70x57mm oberflächenbehandelt, je nach Länge Wandträger und -Drehgleiter lt. Liste
- ▶ **2-/3-/4-lfg:** 1 Alu Innenlauf-Profil 70x57mm oberflächenbehandelt + 1, 2 oder 3 Alu Innenlauf-Profile Ø20mm oberflächenbehandelt, je nach Länge Wandträger und -Drehgleiter lt. Liste, 2 Endkappen je Lauf

- ▶ mit Montagematerial
- ▶ Bestellmaß = Profilmaß
- ▶ Trägermitte bis Innenlauf-Profilunterkante 70x57: 31mm
- ▶ Trägermitte bis Innenlauf-Profilunterkante Ø20mm: 28mm
- ▶ bei geänderter Ausführung Aufpreis bzw. Preisänderung
- ▶ **Aus produktionstechnischen Gründen bestehen geringfügige Farbabweichungen zwischen den Karniesenkomponenten.**

Trägermaße

Träger 1-läufig Art. 871 055:

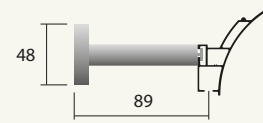

Träger 2-/3-läufig Art. 871 2271:

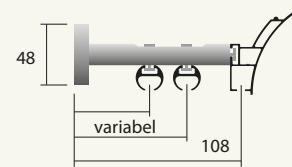

Träger 4-läufig Art. 871 2272:

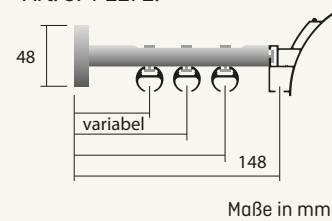





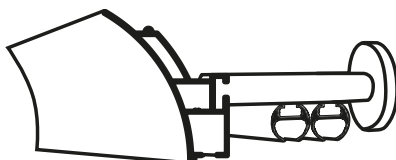



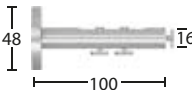
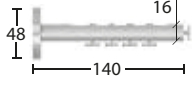
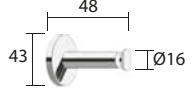
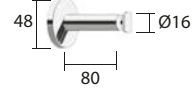
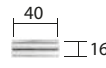
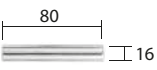
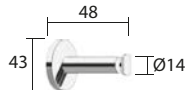
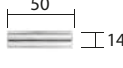



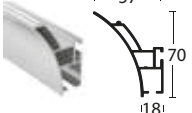

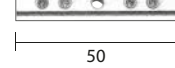
		aluminium matt				schwarz matt				nickel matt				verchromt					
Bestellcode:		t70-201	t70-202	t70-203	t70-204	t70-205	t70-206	t70-207	t70-208	t70-209	t70-210	t70-211	t70-212	t70-213	t70-214	t70-215	t70-216		
Länge (cm)	Wandträger		Gleiter pro Lauf	1lfg	2lfg	3lfg	4lfg	1lfg	2lfg	3lfg	4lfg	1lfg	2lfg	3lfg	4lfg	1lfg	2lfg	3lfg	4lfg
	1lfg.	2-4lfg.																	
100	2	2	16	235	357	452	563	252	395	496	611	303	446	548	663				
120	2	2	18	250	380	483	601	267	420	531	656	328	481	593	718				
140	2	2	22	265	403	514	639	282	445	566	701	353	516	638	773				
160	2	2	26	280	426	545	677	297	470	601	746	378	551	683	828				
180	2	2	28	295	449	576	715	312	495	636	791	403	586	728	883				
200	2	2	32	310	472	607	753	327	520	671	836	428	621	773	938				
220	2	3	34	325	554	697	862	342	618	779	961	453	731	892	1.074				
240	2	3	38	340	577	728	900	357	643	814	1.006	478	766	937	1.129				
260	2	3	42	355	600	759	938	372	668	849	1.051	503	801	982	1.184				
280	3	3	44	418	623	790	976	438	693	884	1.096	582	836	1.027	1.239				
300	3	3	48	433	646	821	1.014	453	718	919	1.141	607	871	1.072	1.294				
320	3	3	50	448	669	852	1.052	468	743	954	1.186	632	906	1.117	1.349				
340	3	3	54	463	692	883	1.090	483	768	989	1.231	657	941	1.162	1.404				
360	3	3	58	478	715	914	1.128	498	793	1.024	1.276	682	976	1.207	1.459				
380	3	3	60	493	738	945	1.166	513	818	1.059	1.321	707	1.011	1.252	1.514				
400	3	4	64	508	821	1.033	1.277	528	915	1.166	1.444	732	1.121	1.371	1.650				
+ 20cm ▲			3	15	23	31	38	15	25	35	45	25	35	45	55				

- ▲ Träger 1-läufig: ab einer Länge von 520 cm bzw. bei schwereren Vorhängen wird ein weiterer Träger empfohlen
- ▲ Träger 2-4-läufig: ab einer Länge von 580 cm bzw. bei schwereren Vorhängen wird ein weiterer Träger empfohlen



Wandträger mit **runder** Sockelplatte

Träger und passende Verlängerungen			
Multi-Wandträger 1-3lfg., Wandabstand 100mm Stück			
	aluminium matt	871 2271 am	62,40
	nickel matt	871 2271 n	74,40
	verchromt	871 2271 v	74,40
	schwarz matt	871 2271 sm	62,40
Multi-Wandträger 1-5lfg., Wandabstand 140mm Stück			
	aluminium matt	871 2272 am	69,60
	nickel matt	871 2272 n	81,60
	verchromt	871 2272 v	81,60
	schwarz matt	871 2272 sm	69,60
Wandträger 1lfg., Wandabstand 43mm Stück			
	aluminium matt	871 053 am	43,20
	nickel matt	871 053 n	50,40
	verchromt	871 053 v	50,40
	schwarz matt	871 053 sm	43,20
Wandträger 1lfg., Wandabstand 80mm Stück			
	aluminium matt	871 055 am	45,60
	nickel matt	871 055 n	52,80
	verchromt	871 055 v	52,80
	schwarz matt	871 055 sm	45,60
Trägerverlängerung für Wandträger, 40mm Stück			
	aluminium matt	871 044 am	21,60
	nickel matt	871 044 n	21,60
	verchromt	871 044 v	21,60
	schwarz matt	871 044 sm	21,60
Trägerverlängerung für Wandträger, 80mm Stück			
	aluminium matt	871 066 am	24,-
	nickel matt	871 066 n	24,-
	verchromt	871 066 v	24,-
	schwarz matt	871 066 sm	24,-
Wandträger 1lfg., Wandabstand 43mm/Ø14mm Stück			
	schwarz matt	871 053 sm	34,80
Trägerverlängerung 50mm Stück			
	schwarz matt	810 735 sm	16,80
Endkappe flächenbündig Rechts Stück			
	aluminium matt	830 064 am	36,-
	nickel matt	830 064 n	36,-
	verchromt	830 064 v	40,80
	schwarz matt	830 064 sm	36,-
Endkappe flächenbündig Links Stück			
	aluminium matt	830 063 am	36,-
	nickel matt	830 063 n	36,-
	verchromt	830 063 v	40,80
	schwarz matt	830 063 sm	36,-
Endkappe flächenbündig Ø20mm Stück			
	aluminium matt	831 420 am	28,80
	nickel matt	831 420 n	28,80
	verchromt	831 420 v	28,80
	schwarz matt	831 420 sm	22,80
Wandlager Ø20mm Stück			
	aluminium matt	82 320 am	34,80
	nickel matt	82 320 n	38,40
	verchromt	82 320 v	38,40
	schwarz matt	82 320 sm	33,60
Innenlauf C-Profil 70x57mm, Stange 6m Meter			
	aluminium matt	n90 780 am	75,40
	nickel matt	n90 780 n	75,40
	verchromt	n90 780 v	127,40
	schwarz matt	n90 780 sm	75,40
Alu Innenlauf-Profil Ø20mm, Stange 6m Meter			
	aluminium matt	n90 620 am	41,40
	nickel matt	n90 620 n	63,50
	verchromt	n90 620 v	63,50
	schwarz matt	n90 620 sm	38,60
Profilverbinder Messing Stück			
	vernickelt	904 071	12,-
KLIXI-Drehgleiter 100 Stück Beutel			
	Kunststoff grau	2400 100 g	12,-
	Kunststoff weiß	2400 100 w	12,-
Gleiter 100 Stück Beutel			
	Kunststoff weiß	3942 100	5,40
Ösengleiter 100 Stück Beutel			
	Kunststoff weiß	3910 100	9,90
Gardinen-Einfachhaken 100 Stück Beutel			
	Kunststoff weiß	601 100	6,50
Gardinen-Doppelhaken 100 Stück Beutel			
	Kunststoff weiß	605 100	11,-
Roller mit Faltenleghaken Stück			
	Kunststoff weiß	2420	0,20
Roller mit Kugellager nur für Profil n90780 Stück			
	Kunststoff	904 074	1,10



PROFIL 40-70

V-Profil
70x42mm

Profil
40-70



mit KLIXI
Drehgleiter

Erker Ausführung nicht möglich!



Biegung



Gehrung



Gelenk



Farben Zubehör & Stangen



aluminium matt



nickel matt



verchromt

V-Profil 70x42mm

Garnituren mit Multi-Wandträgern mit Endkappen





aluminium matt, 1-läufig
Maßstab 1:1



nickel matt, 1-läufig
Maßstab 1:1

Lieferumfang

- ▶ **1 lfg:** 1 Alu Innenlauf-Profil 70x42mm oberflächenbehandelt, je nach Länge Wandträger und -Drehgleiter lt. Liste
 - ▶ **2-/3-/4-lfg:** 1 Alu Innenlauf-Profil 70x42mm oberflächenbehandelt + 1, 2 oder 3 Alu Innenlauf-Profile 20x20mm oberflächenbehandelt, je nach Länge Wandträger und -Drehgleiter lt. Liste, 2 Endkappen je Lauf
- ▶ mit Montagematerial
 - ▶ Bestellmaß = Profilmaß
 - ▶ Trägermitte bis Innenlauf-Profilunterkante 70x42: 31mm
 - ▶ Trägermitte bis Innenlauf-Profilunterkante 20x20mm: 28mm
 - ▶ bei geänderter Ausführung Aufpreis bzw. Preisänderung
 - ▶ **Aus produktionstechnischen Gründen bestehen geringfügige Farbabweichungen zwischen den Karniesenkomponenten.**

Trägermaße

Träger 1-läufig Art. 871 207:

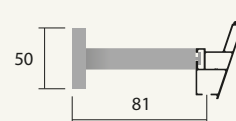

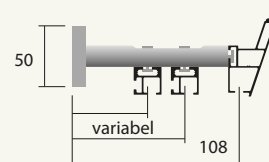

Träger 2-/3-läufig Art. 871 2281:

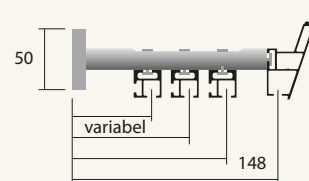

Träger 4-läufig Art. 871 2282:



Maße in mm

				 aluminium matt				 nickel matt				 verchromt			
Bestellcode:				t70-217	t70-218	t70-219	t70-220	t70-221	t70-222	t70-223	t70-224	t70-225	t70-226	t70-227	t70-228
Länge (cm)	Wandträger		Gleiter pro Lauf	1lfg	2lfg	3lfg	4lfg	1lfg	2lfg	3lfg	4lfg	1lfg	2lfg	3lfg	4lfg
	1lfg.	2-4lfg.													
100	2	2	16	255	355	444	544	294	407	515	636	345	481	613	756
120	2	2	18	270	378	476	584	309	432	551	682	370	521	668	826
140	2	2	22	285	401	508	624	324	457	587	728	395	561	723	896
160	2	2	26	300	424	540	664	339	482	623	774	420	601	778	966
180	2	2	28	315	447	572	704	354	507	659	820	445	641	833	1.036
200	2	2	32	330	470	604	744	369	532	695	866	470	681	888	1.106
220	2	3	34	345	558	697	854	384	634	805	994	495	798	1.020	1.259
240	2	3	38	360	581	729	894	399	659	841	1.040	520	838	1.075	1.329
260	2	3	42	375	604	761	934	414	684	877	1.086	545	878	1.130	1.399
280	3	3	44	447	627	793	974	502	709	913	1.132	646	918	1.185	1.469
300	3	3	48	462	650	825	1.014	517	734	949	1.178	671	958	1.240	1.539
320	3	3	50	477	673	857	1.054	532	759	985	1.224	696	998	1.295	1.609
340	3	3	54	492	696	889	1.094	547	784	1.021	1.270	721	1.038	1.350	1.679
360	3	3	58	507	719	921	1.134	562	809	1.057	1.316	746	1.078	1.405	1.749
380	3	3	60	522	742	953	1.174	577	834	1.093	1.362	771	1.118	1.460	1.819
400	3	4	64	537	830	1.046	1.283	592	937	1.203	1.490	796	1.235	1.593	1.973
+ 20cm ▲			3	15	23	32	40	15	25	36	46	25	40	55	70

▲ Träger 1-läufig: ab einer Länge von 520 cm bzw. bei schwereren Vorhängen wird ein weiterer Träger empfohlen

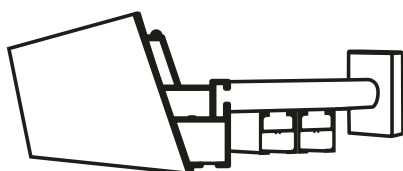

▲ Träger 2-4-läufig: ab einer Länge von 580 cm bzw. bei schwereren Vorhängen wird ein weiterer Träger empfohlen

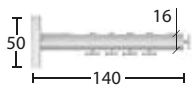
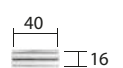
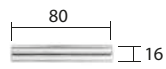

Wandträger mit quadratischer Sockelplatte

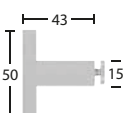
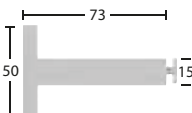
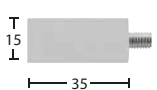
Träger und passende Verlängerungen			
Multi-Wandträger 1-3lfg., Wandabstand 100mm			
	aluminium matt	871 2281 am	64,80
	nickel matt	871 2281 n	76,80
	verchromt	871 2281 v	76,80
Multi-Wandträger 1-5lfg., Wandabstand 140mm			
	aluminium matt	871 2282 am	70,80
	nickel matt	871 2282 n	82,80
	verchromt	871 2282 v	82,80
Trägerverlängerung für Wandträger, 40mm			
	aluminium matt	871 044 am	21,60
	nickel matt	871 044 n	21,60
	verchromt	871 044 v	21,60
Trägerverlängerung für Wandträger, 80mm			
	aluminium matt	871 066 am	24,-
	nickel matt	871 066 n	24,-
	verchromt	871 066 v	24,-

Träger und passende Verlängerungen			
Wandträger 1lfg., Wandabstand 43mm			
	aluminium matt	871 206 am	51,60
	nickel matt	871 206 n	68,40
	verchromt	871 206 v	68,40
Wandträger 1lfg., Wandabstand 80mm			
	aluminium matt	871 207 am	58,80
	nickel matt	871 207 n	74,40
	verchromt	871 207 v	74,40
Trägerverlängerung 35mm			
	aluminium matt	871 208 am	27,60
	nickel matt	871 208 n	33,60
	verchromt	871 208 v	33,60

Endkappe flächenbündig Rechts			
	aluminium matt	830 066 am	36,-
	nickel matt	830 066 n	40,80
	verchromt	830 066 v	40,80
Endkappe flächenbündig Links			
	aluminium matt	830 065 am	36,-
	nickel matt	830 065 n	40,80
	verchromt	830 065 v	40,80
Endkappe flächenbündig 20x20mm			
	aluminium matt	830 127 am	24,-
	nickel matt	830 127 n	28,80
	verchromt	830 127 v	28,80

Innenlauf V-Profil 70x42mm, Stange 6m			Meter
	aluminium matt	n90 781 am	75,40
	nickel matt	n90 781 n	75,40
	verchromt	n90 781 v	127,40

Quadrat-Profil 20x20mm, Stange 6m			Meter
	aluminium matt	n90 670 am	44,20
	nickel matt	n90 670 n	55,20
	verchromt	n90 670 v	80,-

Profilverbinder Messing			Stück
	vernickelt	904 071	12,-

KLIXI-Drehgleiter 100 Stück			Beutel
	Kunststoff grau	2400 100 g	12,-
	Kunststoff weiß	2400 100 w	12,-

Gleiter 100 Stück			Beutel
	Kunststoff weiß	3942 100	5,40

Ösengleiter 100 Stück			Beutel
	Kunststoff weiß	3910 100	9,90

Gardinen-Einfachhaken 100 Stück			Beutel
	Kunststoff weiß	601 100	6,50

Gardinen-Doppelhaken 100 Stück			Beutel
	Kunststoff weiß	605 100	11,-

Roller mit Faltenleghaken			Stück
	Kunststoff weiß	2420	0,20

Roller mit Kugellager nur für Profil n90781			Stück
	Kunststoff	904 074	1,10

mit KLIXI
Drehgleiter

Erkerausführung



Biegung



Gehrung 90°



Gelenk

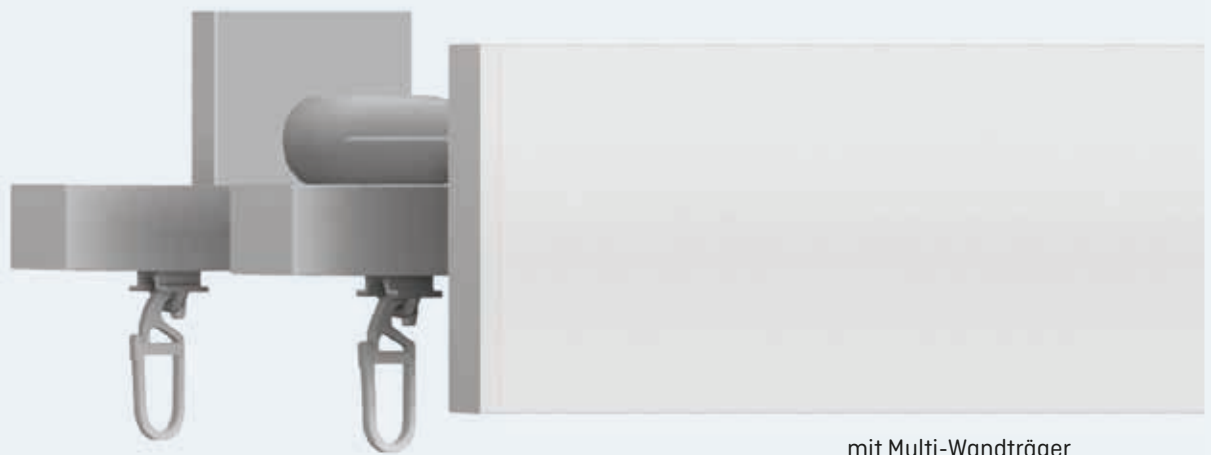

mit Multi-Wandträger



mit Deckenträger

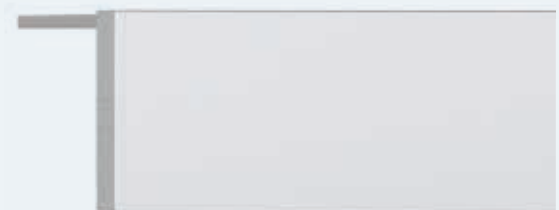

Blende ohne Karniesensystem
mit Winkel-Deckenträger

Farben Zubehör & Stangen



aluminium matt



nickel matt



verchromt



weiß



schwarz matt

Blendsystem Flach 60mm

Komplettgarnituren mit Multi-Wandträgern inkl. Endkappen

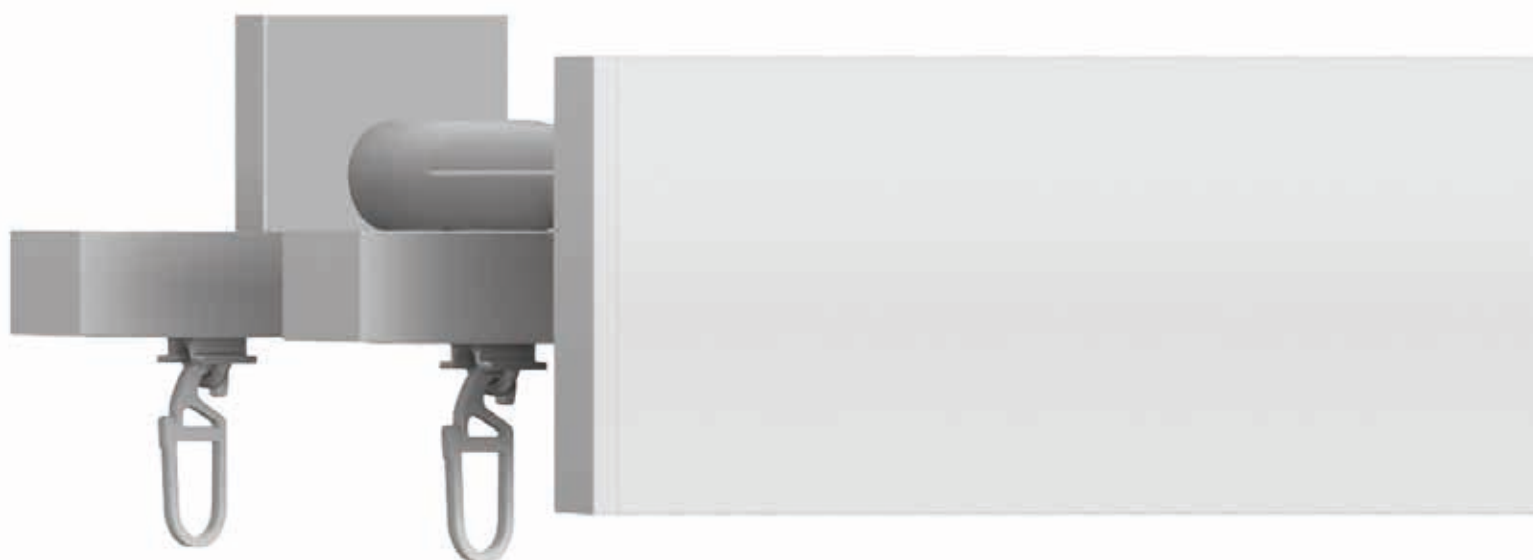

aluminium matt
mit 2-läufigem Multi-Wandträger
Maßstab 1:1

Lieferumfang

- ▶ **1 lfg:** 1 Alu Innenlauf-Profil 20x20mm oberflächenbehandelt
 - ▶ **2 lfg:** 2 Alu Innenlauf-Profile 20x20mm oberflächenbehandelt
 - ▶ **3 lfg:** 3 Alu Innenlauf-Profile 20x20mm oberflächenbehandelt
 - ▶ 1 flache Aluminium-Blende 60x7mm oberflächenbehandelt inkl. 2 Endkappen pro Blende, je nach Länge Wandträger und -Drehgleiter lt. Liste, 2 Endkappen 20x20mm pro Lauf
- ▶ mit Montagematerial
 - ▶ Bestellmaß = Blendenmaß
 - ▶ Trägermitte bis Innenlauf-Profilunterkante 20x20mm: 28mm
 - ▶ bei geänderter Ausführung Aufpreis bzw. Preisänderung
 - ▶ **Aus produktionstechnischen Gründen bestehen geringfügige Farbabweichungen zwischen den Karniesenkomponenten.**

Trägermaße

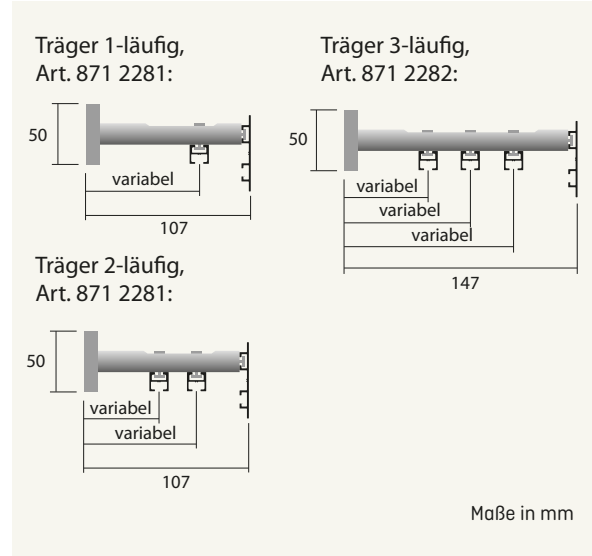

			aluminium matt			nickel matt			verchromt		
Bestellcode:			t60-001	t60-002	t60-003	t60-004	t60-005	t60-006	t60-007	t60-008	t60-009
			weiß								
Bestellcode:			t60-013	t60-014	t60-015						
			schwarz matt								
Bestellcode:			t60-010	t60-011	t60-012	t60-004	t60-005	t60-006	t60-007	t60-008	t60-009
Länge (cm)	Wand-träger	Gleiter 1l./2l.	1lfg [-]	2lfg [-][-]	3lfg [-][-][-]	1lfg [-]	2lfg [-][-]	3lfg [-][-][-]	1lfg [-]	2lfg [-][-]	3lfg [-][-][-]
100	2	16/32	318	406	507	367	470	585	432	557	694
120	2	18/36	335	432	541	388	501	626	466	605	756
140	2	22/44	352	458	575	409	532	667	500	653	818
160	2	26/52	369	484	609	430	563	708	534	701	880
180	2	28/54	386	510	643	451	594	749	568	749	942
200	2	32/64	403	536	677	472	625	790	602	797	1.004
220	3	34/68	485	624	780	564	727	906	707	918	1.146
240	3	38/76	502	650	814	585	758	947	741	966	1.208
260	3	42/84	519	676	848	606	789	988	775	1.014	1.270
280	3	44/88	536	702	882	627	820	1.029	809	1.062	1.332
300	3	48/96	553	728	916	648	851	1.070	843	1.110	1.394
320	3	50/100	570	754	950	669	882	1.111	877	1.158	1.456
340	3	54/108	587	780	984	690	913	1.152	911	1.206	1.518
360	3	58/116	604	806	1.018	711	944	1.193	945	1.254	1.580
380	3	60/120	621	832	1.052	732	975	1.234	979	1.302	1.642
400	4	64/128	705	918	1.155	824	1.076	1.349	1.084	1.423	1.785
+ 20cm	▲	3/6	17	26	34	21	31	41	34	48	62

▲ ab einer Länge von ca. 580 cm bzw. bei schwereren Vorhängen wird ein weiterer Träger empfohlen (Aufpreis)

Komplettgarnituren mit Deckenträgern inkl. Endkappen

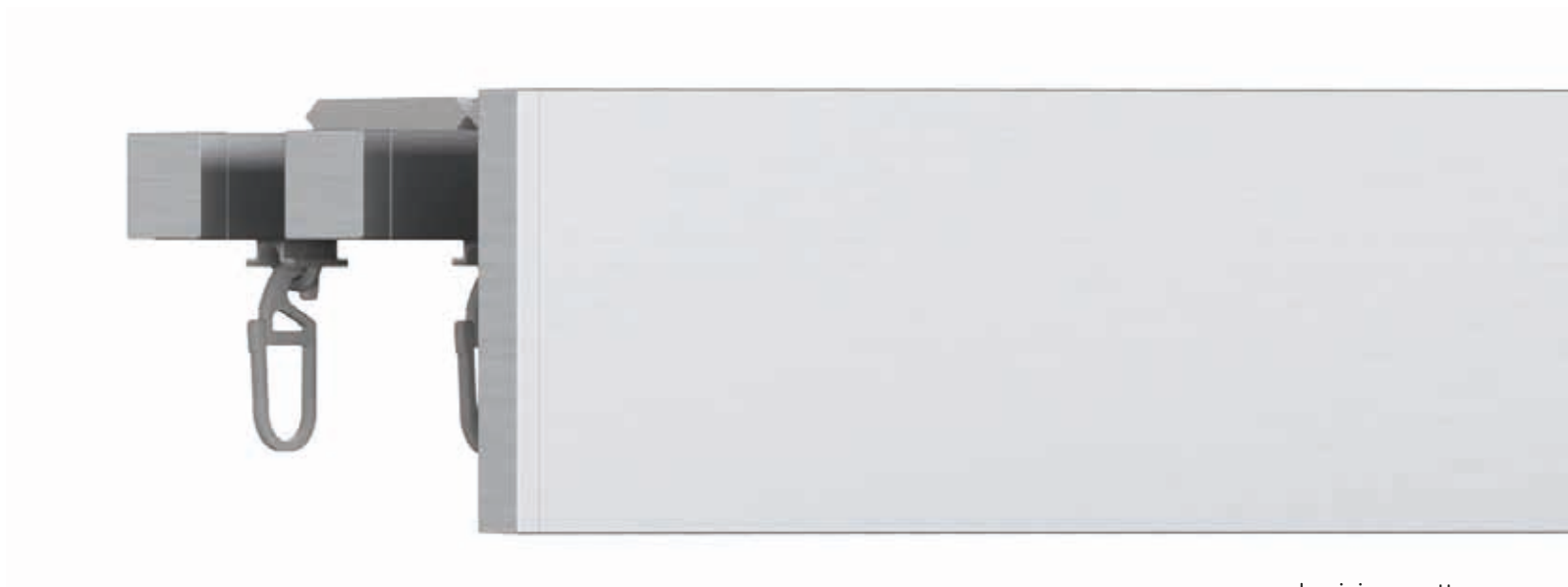

aluminium matt
mit Deckenträger 871 247
Maßstab 1:1



Blende ohne Karniesensystem
mit Winkel-Deckenträger Art. 871 237
Preise siehe Einzelteile Seite 276

Lieferumfang

- ▶ **1 lfg:** 1 Alu Innenlauf-Profil 20x20mm oberflächenbehandelt
 - ▶ **2 lfg:** 2 Alu Innenlauf-Profile 20x20mm oberflächenbehandelt
 - ▶ **3 lfg:** 3 Alu Innenlauf-Profile 20x20mm oberflächenbehandelt
 - ▶ 1 flache Aluminium-Blende 60x7mm oberflächenbehandelt inkl. 2 Endkappen pro Blende, je nach Länge Deckenträger und -Drehgleiter lt. Liste, 2 Endkappen 20x20mm pro Lauf
- ▶ bis zu 5-läufig möglich
 - ▶ mit Montagematerial
 - ▶ Bestellmaß = Blendenmaß
 - ▶ Decke bis Innenlauf-Profilunterkante 20x20mm: 26mm
 - ▶ bei geänderter Ausführung Aufpreis bzw. Preisänderung
 - ▶ **Aus produktionstechnischen Gründen bestehen geringfügige Farbabweichungen zwischen den Karniesenkomponenten.**

Trägermaße

Träger 1-läufig, Art. 871 247:

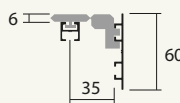



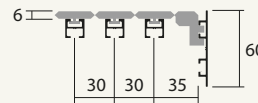

Träger 3-läufig, Art. 871 247:

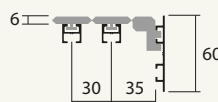

Träger 2-läufig, Art. 871 247:



Maße in mm

			 aluminium matt			 nickel matt			 verchromt		
Bestellcode:			t60-021	t60-022	t60-023						
			 weiß								
Bestellcode:			t60-033	t60-034	t60-035						
			 schwarz matt								
Bestellcode:			t60-030	t60-031	t60-032	t60-024	t60-025	t60-026	t60-027	t60-028	t60-029
Länge (cm)	Wand-träger	Gleiter 1l./2l.	1lfg [-]	2lfg [-][-]	3lfg [-][-][-]	1lfg [-]	2lfg [-][-]	3lfg [-][-][-]	1lfg [-]	2lfg [-][-]	3lfg [-][-][-]
100	2	16/32	213	303	393	245	349	454	310	436	563
120	2	18/36	230	329	427	266	380	495	344	484	625
140	2	22/44	247	355	461	287	411	536	378	532	687
160	2	26/52	264	381	495	308	442	577	412	580	749
180	2	28/54	281	407	529	329	473	618	446	628	811
200	2	32/64	298	433	563	350	504	659	480	676	873
220	3	34/68	328	469	609	381	545	710	524	737	949
240	3	38/76	345	495	643	402	576	751	558	785	1.011
260	3	42/84	362	521	677	423	607	792	592	833	1.073
280	3	44/88	379	547	711	444	638	833	626	881	1.135
300	3	48/96	396	573	745	465	669	874	660	929	1.197
320	3	50/100	413	599	779	486	700	915	694	977	1.259
340	3	54/108	430	625	813	507	731	956	728	1.025	1.321
360	3	58/116	447	651	847	528	762	997	762	1.073	1.383
380	3	60/120	464	677	881	549	793	1.038	796	1.121	1.445
400	4	64/128	495	711	927	580	834	1.088	840	1.181	1.523
+ 20cm	▲	3/6	17	26	34	21	31	41	34	48	62

▲ ab einer Länge von ca. 580 cm bzw. bei schwereren Vorhängen wird ein weiterer Träger empfohlen (Aufpreis)

Träger und passende Verlängerungen				
Multi-Wandträger 1-3lfg., Wandabstand 100mm Stück				
	aluminium matt	871 2281 am	64,80	
	verchromt	871 2281 v	76,80	
	nickel matt	871 2281 n	76,80	
	weiß	871 2281 w	64,80	
	schwarz matt	871 2281 sm	64,80	
Multi-Wandträger 1-5lfg., Wandabstand 140mm Stück				
	aluminium matt	871 2282 am	70,80	
	verchromt	871 2282 v	82,80	
	nickel matt	871 2282 n	82,80	
	weiß	871 2282 w	70,80	
	schwarz matt	871 2282 sm	70,80	
Trägerverlängerung für Wand-/Deckenträger, 40mm Stück				
	aluminium matt	871 044 am	21,60	
	verchromt	871 044 v	21,60	
	nickel matt	871 044 n	21,60	
	weiß	871 044 w	21,60	
	schwarz matt	871 044 sm	21,60	
Trägerverlängerung für Wand-/Deckenträger, 80mm Stück				
	aluminium matt	871 066 am	24,-	
	verchromt	871 066 v	24,-	
	nickel matt	871 066 n	24,-	
	weiß	871 066 w	24,-	
	schwarz matt	871 066 sm	24,-	

Deckenträger 1 bis 5-läufig				Stück
	weiß	871 247	10,80	

Deckenträger 1lfg., Deckenabstand 6mm				Stück
	aluminium matt	871 2091 am	28,80	
	verchromt	871 2091 v	33,60	
	nickel matt	871 2091 n	33,60	
	weiß	871 2091 w	28,80	
	schwarz matt	871 2091 sm	28,80	

Winkel-Deckenträger für Blende				Stück
	aluminium blank	871 237	16,80	

Endkappe flächenbündig für Blende flach				Stück
	aluminium matt	830 061 am	28,80	
	nickel matt	830 061 n	34,80	
	verchromt	830 061 v	34,80	
	weiß	830 061 w	28,80	
	schwarz matt	830 061 sm	28,80	

Endkappe flächenbündig Quadrat 20x20mm				Stück
	aluminium matt	830 127 am	24,-	
	verchromt	830 127 v	28,80	
	nickel matt	830 127 n	28,80	
	weiß	830 127 w	24,-	
	schwarz matt	830 127 sm	24,-	

Blende flach 60x7mm, Stange 6m			Meter
	aluminium matt	n90 760 am	48,30
	verchromt	n90 760 v	115,20
	nickel matt	n90 760 n	62,40
	weiß	n90 760 w	48,30
	schwarz matt	n90 760 sm	48,30

Eckverbinder 90° für Blende flach 60x7mm			Stück
	aluminium matt	89 105 am	34,80
	verchromt	89 105 v	40,80
	nickel matt	89 105 n	40,80
	weiß	89 105 w	34,80
	schwarz matt	89 105 sm	34,80

Quadrat-Innenlauf-Profil 20x20mm, Stange 6m			Meter
	aluminium matt	n90 670 am	44,20
	verchromt	n90 670 v	80,-
	nickel matt	n90 670 n	55,20
	weiß	n90 670 w	44,20
	schwarz matt	n90 670 sm	44,20

Gehungsschnitt (ohne Profilverbinder)			Gehrung
	90°	1bg-1gs-90	20,-

Profilverbinder Messing, beliebiger Winkel			Stück
	vernickelt	904 072 - bw	28,80

Profilverbinder Messing			Stück
	vernickelt	904 071	12,-

Gleiter 100 Stück			Beutel
	Kunststoff weiß	3942 100	5,40

KLIXI-Drehgleiter 100 Stück			Beutel
	Kunststoff grau	2400 100 g	12,-
	Kunststoff weiß	2400 100 w	12,-

Ösengleiter 100 Stück			Beutel
	Kunststoff weiß	3910 100	9,90

Gardinen-Einfachhaken 100 Stück			Beutel
	Kunststoff weiß	601 100	6,50

Gardinen-Doppelhaken 100 Stück			Beutel
	Kunststoff weiß	605 100	11,-

Roller mit Faltenleghaken			Stück
	Kunststoff weiß	2420	0,20



Iron

Iron Design Ø20mm

Übersicht	Seite 280
Endknöpfe	Seite 281
Innenlauf-Wandträger	Seite 287
Innenlauf-Deckenträger	Seite 287
Offene Wandträger Rund	Seite 291

Iron Style Ø20mm

Übersicht	Seite 296
Endknöpfe	Seite 297
Geschlossene Wandträger	Seite 305
Offene Wandträger	Seite 309

Iron Design Ø28 mm

Übersicht	Seite 314
Endknöpfe	Seite 315
Innenlauf-Wandträger	Seite 319
Innenlauf-Deckenträger	Seite 319
Offene Wandträger Glatt	Seite 323

OOOOO
fLIX

Ø20

Iron Design
Ø20



Iron Design Ø20mm

Iron Design Ø20 mm - Trägersysteme



Iron Design Ø20 mm - Endknöpfe





Apollon
FLÄCHENBÜNDIG

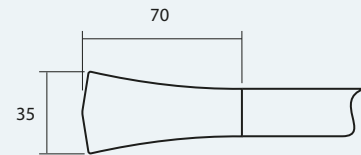

Olymp
FLÄCHENBÜNDIG

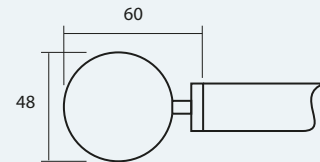

Termoli
FLÄCHENBÜNDIG

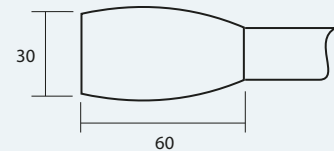

Endknöpfe Iron Design Ø20mm

Apollon

FLÄCHENBÜNDIG



Endknopf Apollon

		Stück
rost	834 420 ro	58,80
anthrazit	834 420 at	58,80
schwarz matt	834 420 sm	58,80

Olymp

FLÄCHENBÜNDIG



Endknopf Olymp

		Stück
rost	834 720 ro	76,80
anthrazit	834 720 at	76,80
schwarz matt	834 720 sm	76,80

Termoli

FLÄCHENBÜNDIG



Endknopf Termoli

		Stück
rost	836 120 ro	58,80
anthrazit	836 120 at	58,80
schwarz matt	836 120 sm	58,80

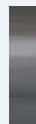

Anna
FLÄCHENBÜNDIG

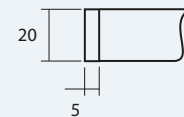

Sabine

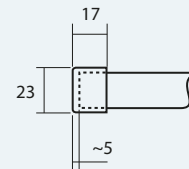

Endknöpfe Iron Design Ø20mm

Anna

FLÄCHENBÜNDIG



rost





schwarz matt



anthrazit
Maßstab 1:1

Endknopf Anna

Stück

rost	 831 420 ro	28,80
anthrazit	 831 420 at	28,80
schwarz matt	 831 420 sm	22,80

Sabine



anthrazit





schwarz matt



rost
Maßstab 1:1

Endknopf Sabine

Stück

rost	 830 020 ro	19,20
anthrazit	 830 020 at	19,20
schwarz matt	 830 020 sm	14,40

○○○○○○
FLIX

Ø20

Iron Design
Ø20

Träger-
systeme



Iron Design Ø20mm Trägersysteme

Iron Design Ø20 mm - Trägersysteme

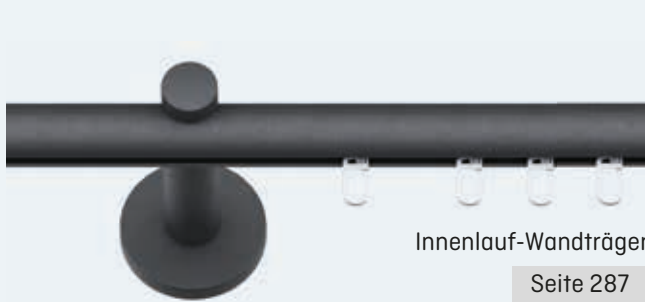

Farben Zubehör

Farben Stangen



Farben Zubehör

Farben Stangen



Farben Zubehör & Stangen



mit KLIXI
Drehgleiter

Erkerausführung

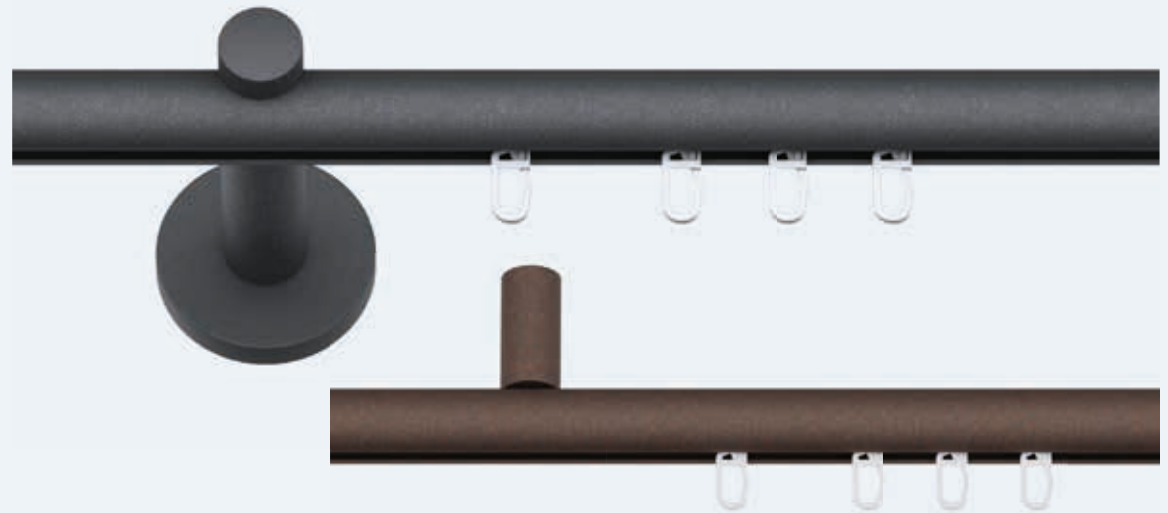

Farben Zubehör



rost

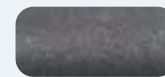

anthrazit

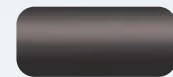

schwarz matt

Farben Innenlauf-Profile



rost*

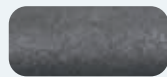

anthrazit*

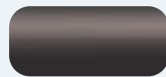

schwarz matt



buche*



wildeiche*



zwetschke*

* IL-Profile in rost, anthrazit, buche, wildeiche, zwetschke: Laufroller Art. 2420

Innenlauf-Wandträger Innenlauf-Deckenträger

Garnituren mit Innenlaufwand-/deckenträger ohne Endknöpfe



anthrazit
1-läufig
Maßstab 1:1





rost
mit Deckenträger 871 077
Maßstab 1:1



schwarz matt
2-läufig
Maßstab 1:1

Lieferumfang

- ▶ **1 lfg:** 1 Alu Innenlauf-Profil Ø20mm oberflächenbehandelt, je nach Länge Wandträger und -Drehgleiter lt. Liste
- ▶ **2 lfg:** 2 Alu Innenlauf-Profile Ø20mm oberflächenbehandelt, je nach Länge Wandträger und -Drehgleiter lt. Liste, 2 Endkappen
- ▶ **1 lfg mit Deckenträger 15mm Deckenabstand**
- ▶ **1 lfg mit Deckenträger 35mm Deckenabstand**
- ▶ **1 lfg mit Deckenträger 43mm Deckenabstand**
- ▶ **Deckenträger:** 1 Alu Innenlauf-Profil Ø20mm oberflächenbehandelt, je nach Länge Deckenträger und -Drehgleiter lt. Liste

- ▶ mit Montagematerial
- ▶ Bestellmaß = Profilmaß
- ▶ Wandträger: Trägermitte bis Innenlaufprofil-Unterkante: 20mm
- ▶ bei geänderter Ausführung Aufpreis bzw. Preisänderung
- ▶ **IL-Profil in rost, anthrazit, buche, wildeiche, zwetschke: nur Laufroller Art. 2420 ohne Aufpreis**



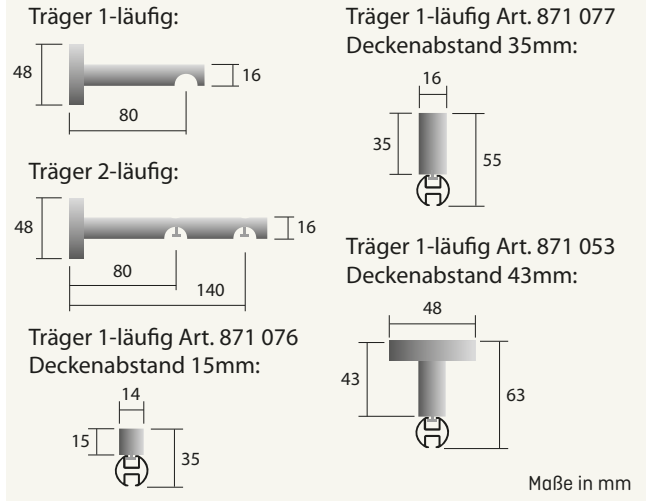











Trägermaße







▶ **Aus produktionstechnischen Grunden bestehen geringfugige Farbabweichungen zwischen den Karniesenkomponenten.**

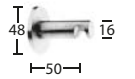

Iron Design
Ø20

Trager-
systeme

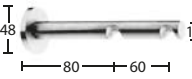
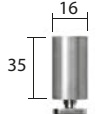
		rost				rost							Preisnderung fur IL-Profil in:				
Bestellcode:		t20-201	t20-202			t20-376	t20-377	t20-378									
		anthrazit		schwarz matt		anthrazit			schwarz matt								
Bestellcode:		Wandtrager				Deckentrager											
		t20-203	t20-204	t20-213	t20-214	t20-373	t20-374	t20-375	t20-370	t20-371	t20-372						
Lange (cm)	Wand-trager	Gleiter 1l./2l.	1lfg	2lfg	1lfg	2lfg	1lfg	1lfg	1lfg	1lfg	1lfg	1lfg	1lfg	1lfg	1lfg	2lfg	
																	
100	2	16/32	150	264	139	234	93	105	133	79	84	105	-8	-16			
120	2	18/36	160	283	147	249	103	115	143	86	91	112	-9	-18			
140	2	22/44	170	302	155	264	113	125	153	93	98	119	-10	-20			
160	2	26/52	180	321	163	279	123	135	163	100	105	126	-11	-22			
180	2	28/54	190	340	171	294	133	145	173	107	112	133	-12	-24			
200	2	32/64	200	359	179	309	143	155	183	114	119	140	-13	-26			
220	3	34/68	258	444	235	389	173	191	233	144	151	183	-14	-28			
240	3	38/76	268	463	243	404	183	201	243	151	158	190	-15	-30			
260	3	42/84	278	482	251	419	193	211	253	158	165	197	-16	-32			
280	3	44/88	288	501	259	434	203	221	263	165	172	204	-17	-34			
300	3	48/96	298	520	267	449	213	231	273	172	179	211	-18	-36			
320	3	50/100	308	539	275	464	223	241	283	179	186	218	-19	-38			
340	3	54/108	318	558	283	479	233	251	293	186	193	225	-20	-40			
360	3	58/116	328	577	291	494	243	261	303	193	200	232	-21	-42			
380	3	60/120	338	596	299	509	253	271	313	200	207	239	-22	-44			
400	4	64/128	395	682	354	591	282	306	362	231	240	282	-23	-46			
+ 20cm	▲	3/6	10	19	8	15	10	10	10	7	7	7	-1	-2			
Preisnderung 1-seitig			-16,50	-15,30	-18,00	-13,00											
bei Wandlager 2-seitig			-33,00	-30,60	-35,00	-26,00											

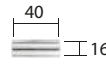
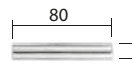
▲ ab einer Lange von ca. 580 cm bzw. bei schwereren Vorhangen wird ein weiterer Trager empfohlen (Aufpreis)

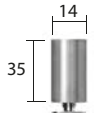
Träger und passende Verlängerungen			
Wandträger 1fg - Wandabstand 50mm Stück			
	rost	871 049 ro	48,-
	anthrazit	871 049 at	48,-
	schwarz matt	871 049 sm	48,-
Wandträger 1fg - Wandabstand 80mm Stück			
	rost	871 045 ro	51,60
	anthrazit	871 045 at	51,60
	schwarz matt	871 045 sm	51,60
Wandträger 2fg - Wandabstand 80/140mm Stück			
	rost	871 046 ro	66,-
	anthrazit	871 046 at	66,-
	schwarz matt	871 046 sm	66,-
Deckenträger, Deckenabstand 35mm/Ø16mm Stück			
	rost	871 077 ro	28,80
	anthrazit	871 077 at	28,80
Deckenträger 1fg., Deckenabstand 43mm/Ø16mm Stück			
	rost	871 053 ro	43,20
	anthrazit	871 053 at	43,20
Trägerverlängerung für Wand-/Deckenträger, 40mm Stück			
	rost	871 044 ro	21,60
	anthrazit	871 044 at	21,60
	schwarz matt	871 044 sm	21,60
Trägerverlängerung für Wand-/Deckenträger, 80mm Stück			
	rost	871 066 ro	24,-
	anthrazit	871 066 at	24,-
	schwarz matt	871 066 sm	24,-

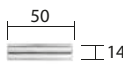
Träger und passende Verlängerungen			
Deckenträger, Deckenabstand 15mm Stück			
	rost	871 076 ro	22,80
	anthrazit	871 076 at	22,80
	schwarz matt	871 076 sm	21,60
Deckenträger, Deckenabstand 35mm/Ø14mm Stück			
	schwarz matt	871 077 sm	24,-
Deckenträger 1fg., Deckenabstand 43mm/Ø14mm Stück			
	schwarz matt	871 053 sm	34,80
Trägerverlängerung 50mm Stück			
	schwarz matt	810 735 sm	16,80

Endkappe Ø20mm			
	rost	830 020 ro	19,20
	anthrazit	830 020 at	19,20
	schwarz matt	830 020 sm	14,40

Endkappe flächenbündig Anna Ø20mm			
	rost	831 420 ro	28,80
	anthrazit	831 420 at	28,80
	schwarz matt	831 420 sm	22,80

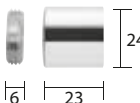
Wandlager Ø20mm			
	rost	82 320 ro	34,80
	anthrazit	82 320 at	34,80
	schwarz matt	82 320 sm	33,60

Alu Innenlauf-Profil Ø20mm, Stange 6mm			
	rost	n90 620 ro	49,70
	anthrazit	n90 620 at	49,70
	schwarz matt	n90 620 sm	38,60
	buche	n90 620 bu	41,40
	wildeiche	n90 620 wi	41,40
	zweitschke	n90 620 zw	41,40

Profilverbinder Messing			
	vernickelt	904 071	12,-

Profilverbinder Messing, beliebiger Winkel			
	vernickelt	904 072 - bw	28,80

Gehungsschnitt (ohne Profilverbinder)			
	90°	1bg-1gs-90	20,-
	beliebiger Winkel	1bg-1gs-bw	49,-

KLIXI-Drehgleiter 100 Stück			
	Kunststoff grau	2400 100 - g	12,-
	Kunststoff weiß	2400 100 - w	12,-

Gleiter 100 Stück			
	Kunststoff weiß	3942 100	5,40

Ösengleiter 100 Stück			
	Kunststoff weiß	3910 100	9,90

Gardinen-Einfachhaken 100 Stück			
	Kunststoff weiß	601 100	6,50

Gardinen-Doppelhaken 100 Stück			
	Kunststoff weiß	605 100	11,-

Roller mit Faltenleghaken			
	Kunststoff weiß	2420	0,20

 Biegungen siehe Gruppe 10

Erkerausführung



Biegung



Gehrung



Gelenk

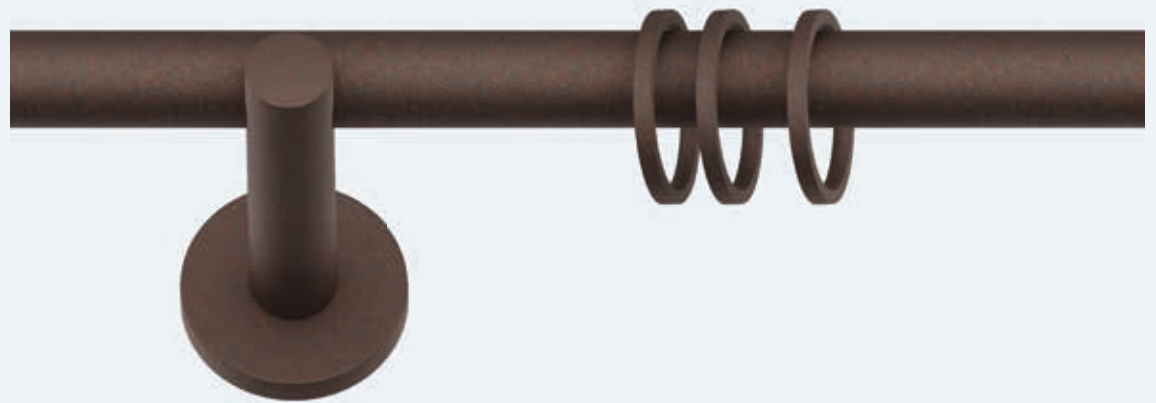

Farben Zubehör & Stangen



rost



anthrazit



schwarz matt

Offene Wandträger Rund

Garnituren mit Offenen Wandträgern Rund ohne Endknöpfe

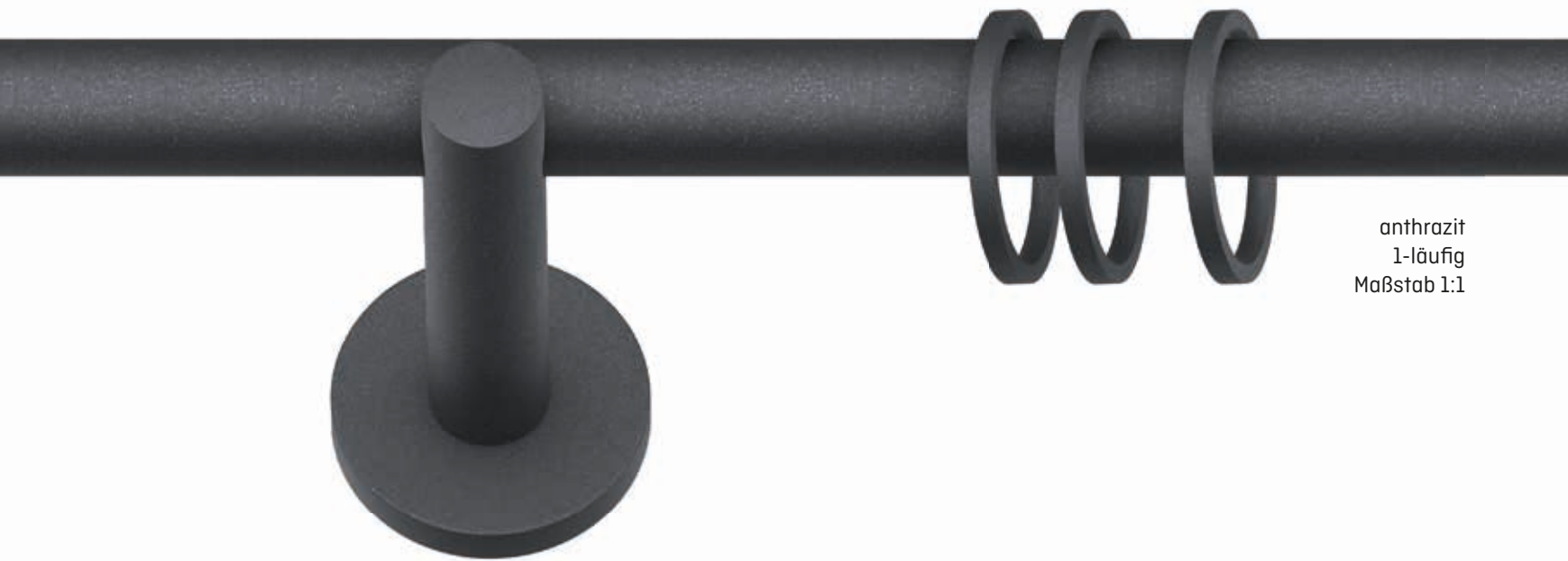

anthrazit
1-läufig
Maßstab 1:1

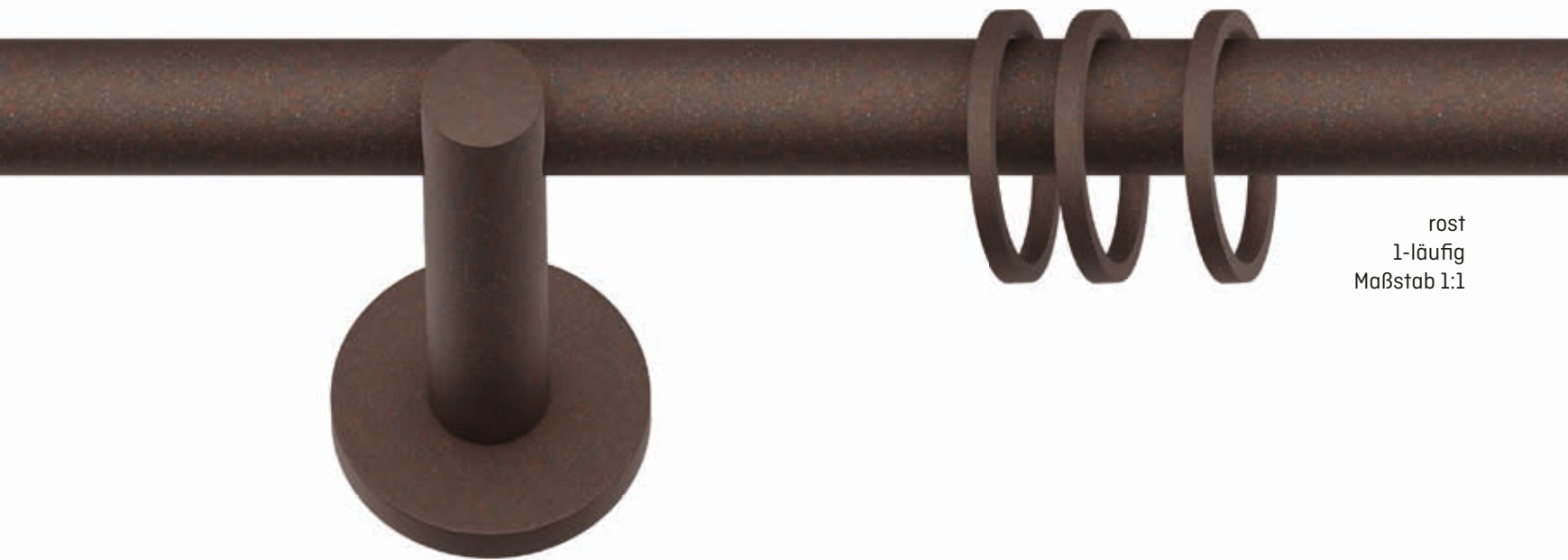

rost
1-läufig
Maßstab 1:1



schwarz matt, 2-läufig
Maßstab 1:1

Lieferumfang

- ▶ **1 lfg:** 1 Aluminium-Rohr Ø20mm oberflächenbehandelt, je nach Länge Wandträger und Flachringe mit Kunstoffeinlage und mit Faltenleghaken lt. Liste
- ▶ **2 lfg:** 2 Aluminium-Rohre Ø20mm oberflächenbehandelt, je nach Länge Wandträger und Flachringe mit Kunstoffeinlage und mit Faltenleghaken lt. Liste, 2 Endkappen

- ▶ mit Montagematerial
- ▶ Bestellmaß = Rohrmaß
- ▶ Trägermitte bis Ringunterkante: 22mm
- ▶ bei geänderter Ausführung Aufpreis bzw. Preisabschlag
- ▶ **Aus produktionstechnischen Gründen bestehen geringfügige Farbabweichungen zwischen den Karniesenkomponenten.**

Trägermaße

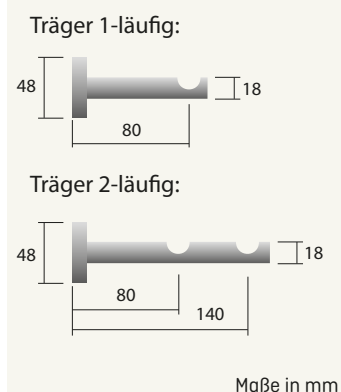





Iron Design
Ø20
Träger-
systeme

			rost		anthrazit		schwarz matt	
Bestellcode:			t20-205	t20-206	t20-207	t20-208	t20-211	t20-212
Länge (cm)	Wand-träger	Ringe 1l./2l.	1lfg	2lfg	1lfg	2lfg	1lfg	2lfg
100	2	14/28	202	370	198	360	176	308
120	2	16/32	222	410	217	399	191	338
140	2	20/40	242	450	236	438	206	368
160	2	22/44	262	490	255	477	221	398
180	2	24/48	282	530	274	516	236	428
200	2	28/56	302	570	293	555	251	458
220	3	30/60	371	670	361	650	314	546
240	3	34/68	391	710	380	689	329	576
260	3	36/72	411	750	399	728	344	606
280	3	38/76	431	790	418	767	359	636
300	3	42/84	451	830	437	806	374	666
320	3	44/88	471	870	456	845	389	696
340	3	48/96	491	910	475	884	404	726
360	3	50/100	511	950	494	923	419	756
380	3	52/104	531	990	513	962	434	786
400	4	56/112	607	1.106	588	1.067	502	886
+ 20 cm ▲		3/6	20	40	19	39	15	30
Preisänderung bei Wandlager	1-seitig		-16,50	-15,30	-16,50	-15,30	-18,00	-13,00
	2-seitig		-33,00	-30,60	-33,00	-30,60	-35,00	-26,00

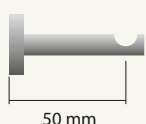
▲ ab einer Länge von ca. 580 cm bzw. bei schwereren Vorhängen wird ein weiterer Träger empfohlen (Aufpreis)

Träger 1-läufig 50mm Art. 815 119



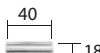
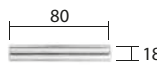

Träger und passende Verlängerungen				
Wandträger 1lfg - Wandabstand 50mm				
	rost	815 119 ro	48,-	Stück
	anthrazit	815 119 at	48,-	
	schwarz matt	815 119 sm	48,-	
Wandträger 1lfg - Wandabstand 80mm				
	rost	815 120 ro	51,60	Stück
	anthrazit	815 120 at	51,60	
	schwarz matt	815 120 sm	51,60	
Wandträger 2lfg - Wandabstand 80/140mm				
	rost	815 520 ro	66,-	Stück
	anthrazit	815 520 at	66,-	
	schwarz matt	815 520 sm	66,-	
Trägerverlängerung 40mm				
	rost	871 043 ro	21,60	Stück
	anthrazit	871 043 at	21,60	
	schwarz matt	871 043 sm	15,60	
Trägerverlängerung 80mm				
	rost	871 065 ro	24,-	Stück
	anthrazit	871 065 at	24,-	
	schwarz matt	871 065 sm	24,-	

Endkappe Ø20mm				
	rost	830 020 ro	19,20	Stück
	anthrazit	830 020 at	19,20	
	schwarz matt	830 020 sm	14,40	

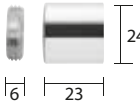
Endkappe flächenbündig Anna Ø20mm				
	rost	831 420 ro	28,80	Stück
	anthrazit	831 420 at	28,80	
	schwarz matt	831 420 sm	22,80	

Wandlager Ø20mm				
	rost	82 320 ro	34,80	Stück
	anthrazit	82 320 at	34,80	
	schwarz matt	82 320 sm	33,60	

Aluminium-Rohr, Ø20mm, Stange 6m				Meter
	rost	al 20 ro	45,50	
	anthrazit	al 20 at	45,50	
	schwarz matt	al 20 sm	27,60	

Flachring Ø20mm mit Kunststoffeinlage + FH				Stück
	rost	848 201 ro	3,60	
	anthrazit	848 201 at	3,60	
	schwarz matt	848 201 sm	3,60	

Faltenleghaken für Flachring				Stück
	Kunststoff glasklar	36003 gk	0,10	

Rohrverbinder Ø20mm				Stück
	Metall/Kunststoff	1720	14,40	

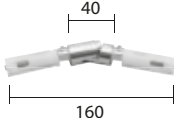
Gelenkverbinder Ø20mm				Stück
	rost	8920 ro	66,-	
	anthrazit	8920 at	66,-	
	schwarz matt	8920 sm	66,-	

OOOO
fLIX

Ø20



Iron Style
Ø20

Iron Style Ø20mm

Iron Style Ø20 mm - Trägersysteme



Iron Style Ø20 mm - Endknöpfe

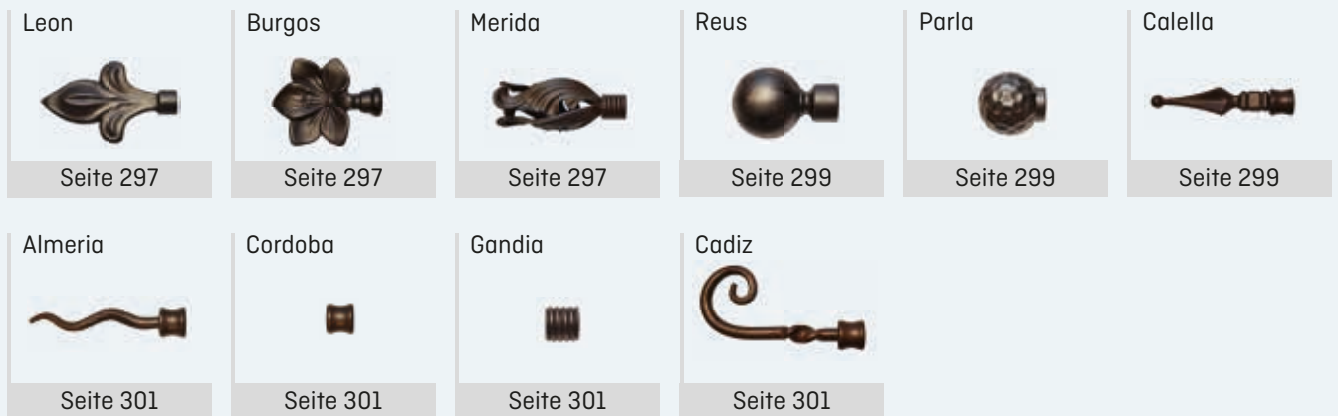



Leon

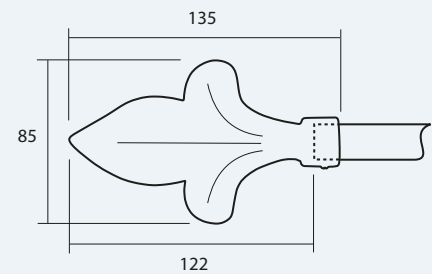

Burgos

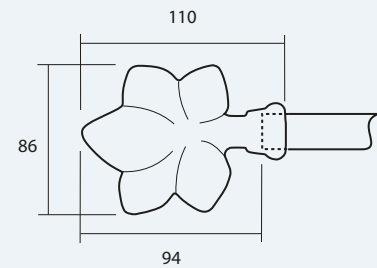

Merida

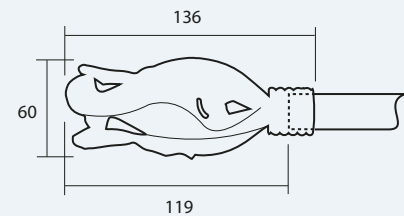

Endknöpfe Iron Style Ø20mm

Leon



rostbraun
Maßstab 1:1



weiß/gold



schwarz

Endknopf Leon

		Stück
rostbraun	736 120 rb	19,90
weiß/gold	736 120 wg	19,90
schwarz	736 120 sw	19,90

Burgos

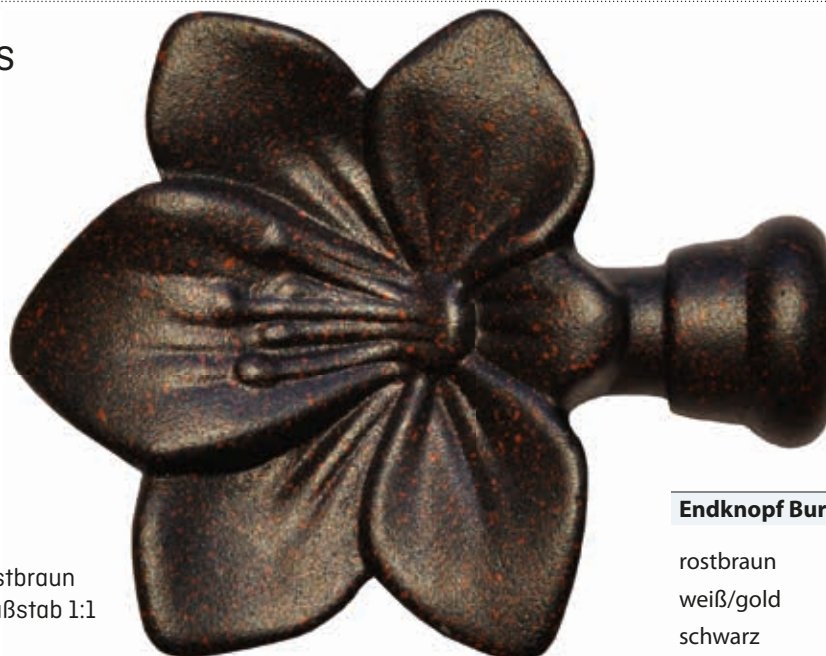

rostbraun
Maßstab 1:1



weiß/gold



schwarz

Endknopf Burgos

		Stück
rostbraun	736 320 rb	19,90
weiß/gold	736 320 wg	19,90
schwarz	736 320 sw	19,90

Merida



rostbraun
Maßstab 1:1



weiß/gold



schwarz

Endknopf Merida

		Stück
rostbraun	735 320 rb	28,50
weiß/gold	735 320 wg	28,50
schwarz	735 320 sw	28,50



Reus

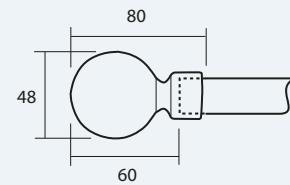

Parla

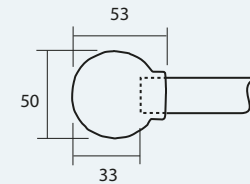

Calella

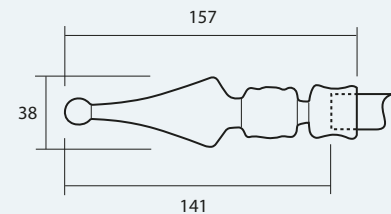

Endknöpfe Iron Style Ø20mm

Reus



Endknopf Reus

		Stück
rostbraun	736 220 rb	24,50
weiß/gold	736 220 wg	24,50
schwarz	736 220 sw	24,50

Parla



Endknopf Parla

		Stück
rostbraun	735 920 rb	24,-
weiß/gold	735 920 wg	24,-
schwarz	735 920 sw	24,-

Calella



Endknopf Calella

		Stück
rostbraun	735 720 rb	42,40
weiß/gold	735 720 wg	42,40
schwarz	735 720 sw	42,40



Almeria

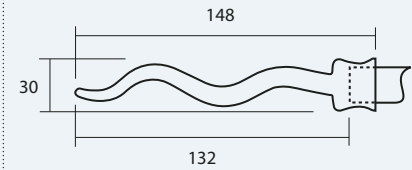

Gandia

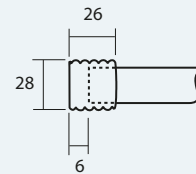

Cordoba

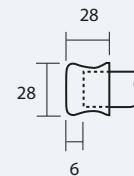

Cadiz

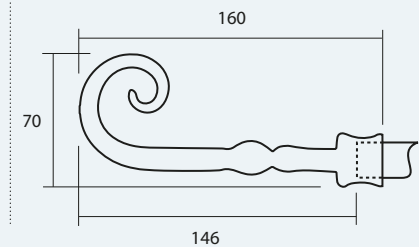

Endknöpfe Iron Style Ø20mm

Almeria



rostbraun
Maßstab 1:1



weiß/gold

schwarz

Endknopf Almeria		Stück
rostbraun	735 620 rb	36,-
weiß/gold	735 620 wg	36,-
schwarz	735 620 sw	36,-

Gandia



rostbraun
Maßstab 1:1



weiß/gold

weiß/gold

schwarz

schwarz

Cordoba



rostbraun
Maßstab 1:1

Endknopf Gandia		Stück
rostbraun	711 925 rb	10,50
weiß/gold	711 925 wg	10,50
schwarz	711 925 sw	10,50

Endknopf Cordoba		Stück
rostbraun	711 924 rb	13,90
weiß/gold	711 924 wg	13,90
schwarz	711 924 sw	13,90

Cadiz



rostbraun
Maßstab 1:1



weiß/gold

schwarz

Endknopf Cadiz		Stück
rostbraun	735 120 rb	41,20
weiß/gold	735 120 wg	41,20
schwarz	735 120 sw	41,20

flüX

Ø20

Iron Style
Ø20

Träger-
systeme

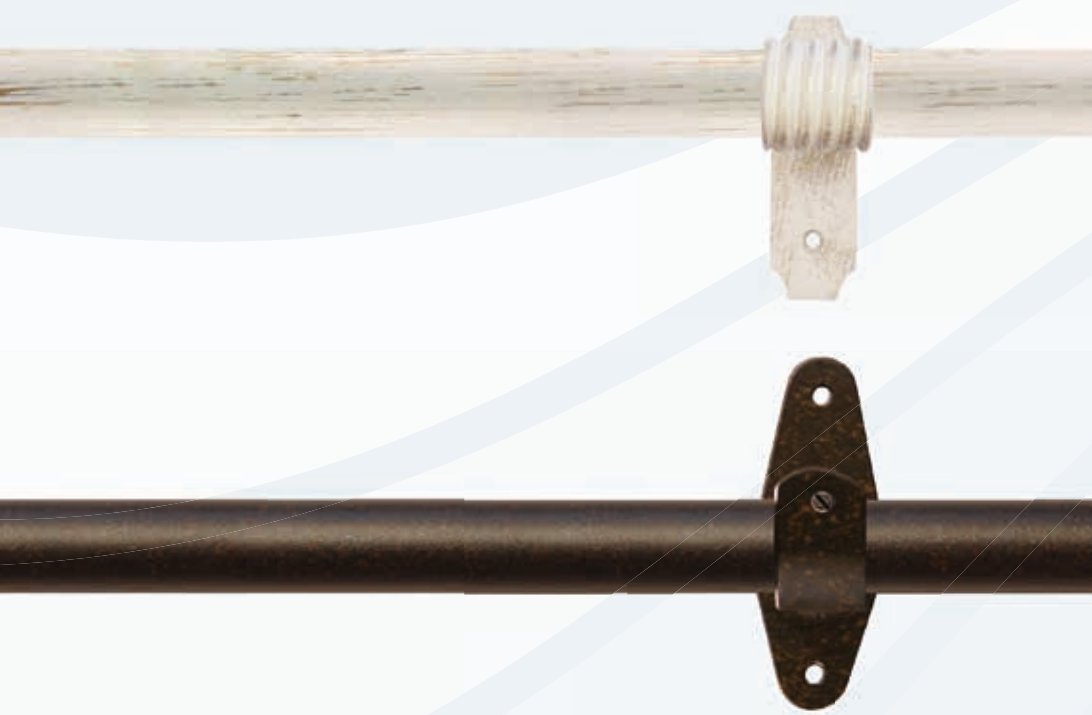

Iron Style Ø20mm Trägersysteme

Iron Style Ø20 mm - Trägersysteme



Farben Zubehör & Stangen



Farben Zubehör & Stangen





IRON

IRON STYLE
Ø20

Iron Style
Ø20

Träger-
systeme

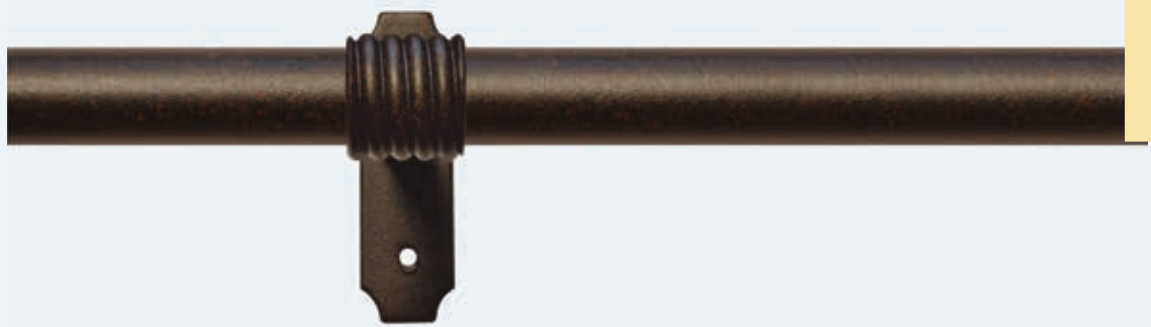

Farben Zubehör & Stangen



rostbraun



weiß/gold



schwarz

Geschlossene Wandträger

Garnituren mit Geschlossenen Wandträgern ohne Endknöpfe



rostbraun
Maßstab 1:1



weiß/gold
Maßstab 1:1



schwarz
Maßstab 1:1

Lieferumfang

- ▶ **1 ffg:** 1 Stahl-Rohr Ø20mm oberflächenbehandelt, je nach Länge Wandträger und Ringe mit Faltenleghaken lt. Liste
 - ▶ **2 ffg:** 2 Stahl-Rohre Ø20mm oberflächenbehandelt, je nach Länge Wandträger und Ringe mit Faltenleghaken lt. Liste, 2 Endkappen
- ▶ mit Montagematerial
 - ▶ Bestellmaß = Rohrmaß
 - ▶ Trägermitte bis Ringunterkante: 22mm
 - ▶ bei geänderter Ausführung Aufpreis bzw. Preisabschlag
 - ▶ **Aus produktionstechnischen Gründen bestehen geringfügige Farbabweichungen zwischen den Karniesenkomponenten.**

Trägermaße

Träger 1-läufig:

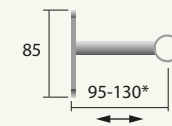

Träger 2-läufig:

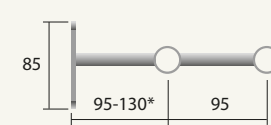

*ausziehbar von-bis Maße in mm

			rostbraun		weiß/gold		schwarz	
Bestellcode:			t20-260	t20-265	t20-270	t20-275	t20-280	t20-285
Länge (cm)	Wand-träger	Ringe 1l./2l.	1fg ○	2fg ○○	1fg ○	2fg ○○	1fg ○	2fg ○○
100	2	14/28	103	204	99	198	95	189
120	2	16/32	113	224	109	218	104	207
140	2	20/40	123	244	119	238	113	225
160	2	22/44	133	264	129	258	122	243
180	2	24/48	143	284	139	278	131	261
200	2	28/56	153	304	149	298	140	279
220	3	30/60	189	364	181	354	174	336
240	3	34/68	199	384	191	374	183	354
260	3	36/72	209	404	201	394	192	372
280	3	38/76	219	424	211	414	201	390
300	3	42/84	229	444	221	434	210	408
320	3	44/88	239	464	231	454	219	426
340	3	48/96	249	484	241	474	228	444
360	3	50/100	259	504	251	494	237	462
380	3	52/104	269	524	261	514	246	480
400	4	56/112	323	622	312	607	282	543
+ 20cm ▲		3/6	10	20	10	20	9	18
Preisänderung bei Wandlager	1-seitig		-18,50	-37,70	-18,50	-37,70	-16,90	-35,30
	2-seitig		-37,00	-75,40	-37,00	-75,40	-33,80	-70,50

▲ ab einer Länge von ca. 580 cm bzw. bei schwereren Vorhängen wird ein weiterer Träger empfohlen (Aufpreis)

— — — — — Rohre über 300cm Länge werden geteilt geliefert, Rohrverbinder im Preis enthalten!

Iron Style
Ø20

Träger-systeme

Wandträger 1lfg - Wandabstand 95-130mm Stück



rostbraun	711 720 rb	26,-
weiß/gold	711 720 wg	26,-
schwarz	711 720 sw	24,-

Wandträger 2lfg - Wandabstand 95-130 + 95mm Stück



rostbraun	711 9221 rb	43,70
weiß/gold	711 9221 wg	43,70
schwarz	711 9221 sw	41,20

Endkappe Ø20mm Stück



rostbraun	711 925 rb	10,50
weiß/gold	711 925 wg	10,50
schwarz	711 925 sw	10,50

Wandlager Ø20mm Stück



rostbraun	711 923 rb	6,20
weiß/gold	711 923 wg	6,20
schwarz	711 923 sw	6,-

Stahl-Rohr, Ø20mm, Stange ca. 3m Meter



rostbraun	sr 20 rb	48,50
weiß/gold	sr 20 wg	48,50
schwarz	sr 20 sw	48,50

Rohrverbinder Ø20mm Stück



Metall/Kunststoff	1720	14,40
-------------------	------	-------

Ring + FH Stück

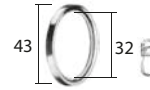

rostbraun	7411 rb	2,40
weiß/gold	7411 wg	2,40
schwarz	7411 sw	2,20

Faltenleghaken Stück



Kunststoff glasklar	36006 gk	0,10
---------------------	----------	------



Farben Zubehör & Stangen

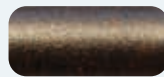

rostbraun



weiß/gold



schwarz

Offene Wandträger

Garnituren mit Offenen Wandträgern ohne Endknöpfe



rostbraun
mit Wandträger 711 920
Maßstab 1:1



weiß/gold
mit Wandträger 711 920
Maßstab 1:1



schwarz
mit Wandträger 711 920
Maßstab 1:1

Lieferumfang

- ▶ **1 lfg:** 1 Stahl-Rohr Ø20mm oberflächenbehandelt, je nach Länge Wandträger und Ringe mit Faltenleghaken lt. Liste
- ▶ **2 lfg:** 2 Stahl-Rohre Ø20mm oberflächenbehandelt, je nach Länge Wandträger und Ringe mit Faltenleghaken lt. Liste, 2 Endkappen

- ▶ mit Montagematerial
- ▶ Bestellmaß = Rohrmaß
- ▶ Trägermitte bis Ringunterkante: ~26mm
- ▶ bei geänderter Ausführung Aufpreis bzw. Preisabschlag
- ▶ **Aus produktionstechnischen Gründen bestehen geringfügige Farbabweichungen zwischen den Karniesenkomponenten.**

Trägermaße

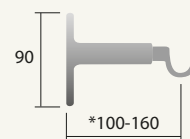

Träger 1-läufig, ausziehbar:
Art. 711 920

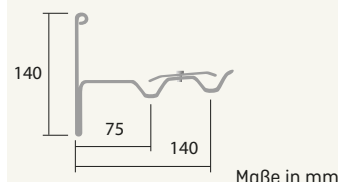

*ausziehbar von-bis

Träger 2-läufig Art. 711 922:



			 rostrauben		 weiß/gold		 schwarz	
Bestellcode:			t20-210	t20-220	t20-225	t20-235	t20-240	t20-250
Länge (cm)	Wand-träger	Ringe 1l./2l.	1lfg ○	2lfg ○○	1lfg ○	2lfg ○○	1lfg ○	2lfg ○○
100	2	14/28	101	183	96	181	94	175
120	2	16/32	111	203	106	201	103	193
140	2	20/40	121	223	116	221	112	211
160	2	22/44	131	243	126	241	121	229
180	2	24/48	141	263	136	261	130	247
200	2	28/56	151	283	146	281	139	265
220	3	30/60	186	331	176	328	172	315
240	3	34/68	196	351	186	348	181	333
260	3	36/72	206	371	196	368	190	351
280	3	38/76	216	391	206	388	199	369
300	3	42/84	226	411	216	408	208	387
320	3	44/88	236	431	226	428	217	405
340	3	48/96	246	451	236	448	226	423
360	3	50/100	256	471	246	468	235	441
380	3	52/104	266	491	256	488	244	459
400	4	56/112	319	577	306	571	280	515
+ 20cm ▲	3/6		10	20	10	20	9	18
Preisänderung 1-seitig			-15,60	-29,10	-17,00	-29,10	-16,50	-28,40
bei Wandlager 2-seitig			-31,20	-58,30	-34,00	-58,30	-32,90	-56,90

▲ ab einer Länge von ca. 580 cm bzw. bei schwereren Vorhängen wird ein weiterer Träger empfohlen (Aufpreis)

— — — Rohre über 300cm Länge werden geteilt geliefert, Rohrverbinder im Preis enthalten!

Iron Style
Ø20

Träger-
systeme

Wandträger 1lfg ausziehbar - WA 100-160mm Stück

	rostbraun	711 920 rb	25,20
	weiß/gold	711 920 wg	25,20
	schwarz	711 920 sw	24,40

Wandträger 2lfg - Wandabstand 75/145mm Stück

	rostbraun	711 922 rb	43,20
	weiß/gold	711 922 wg	43,20
	schwarz	711 922 sw	42,50

Endkappe Ø20mm Stück

	rostbraun	711 924 rb	13,90
	weiß/gold	711 924 wg	13,90
	schwarz	711 924 sw	13,90

Wandlager Ø20mm Stück

	rostbraun	711 923 rb	6,20
	weiß/gold	711 923 wg	6,20
	schwarz	711 923 sw	6,-

Stahlrohr, Ø20mm, Stange ca. 3m Meter

	rostbraun	sr 20 rb	48,50
	weiß/gold	sr 20 wg	48,50
	schwarz	sr 20 sw	48,50

Rohrverbinder Ø20mm Stück

	Metall/Kunststoff	1720	14,40
---	-------------------	------	-------

Ring + FH Stück

	rostbraun	7411 rb	2,40
	weiß/gold	7411 wg	2,40
	schwarz	7411 sw	2,20

Faltenleghaken Stück

	Kunststoff glasklar	36006 gk	0,10
---	---------------------	----------	------

flIX

Ø28



Iron Design
Ø28

Iron Design Ø28mm

Iron Design Ø28 mm - Trägersysteme



Innenlauf-Wandträger

Seite 319

Farben Zubehör

Farben Stangen



Innenlauf-Deckenträger

Seite 319

Farben Zubehör

Farben Stangen

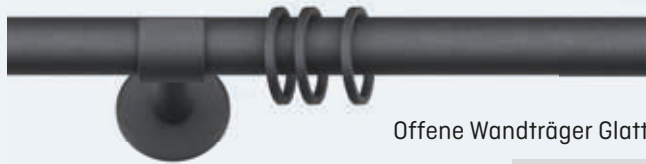

Offene Wandträger Glatt

Seite 323

Farben Zubehör & Stangen



Iron Design Ø28 mm - Endknöpfe

Lava flächenbündig



Seite 315

Olymp flächenbündig



Seite 315

Sabine



Seite 315

Anna flächenbündig



Seite 315



Lava
FLÄCHENBÜNDIG

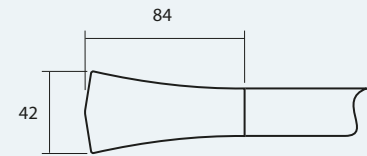

Olymp
FLÄCHENBÜNDIG

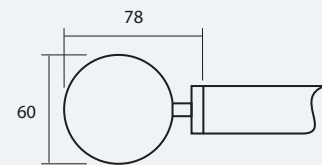

Sabine

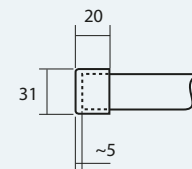

Anna
FLÄCHENBÜNDIG

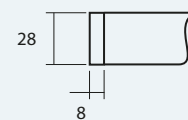

Endknöpfe Iron Design Ø28mm

Lava

FLÄCHENBÜNDIG



anthrazit
Maßstab 1:1

Endknopf Lava		Stück
anthrazit	● 831 029 at	86,40

Olymp

FLÄCHENBÜNDIG

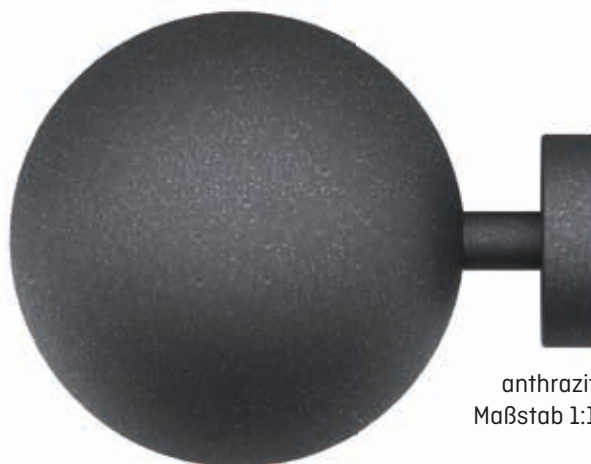

anthrazit
Maßstab 1:1

Endknopf Olymp		Stück
anthrazit	● 834 728 at	86,40

Anna

FLÄCHENBÜNDIG



anthrazit
Maßstab 1:1

Sabine



anthrazit
Maßstab 1:1

Endknopf Anna		Stück
anthrazit	● 831 428 at	34,80

Endknopf Sabine		Stück
anthrazit	● 830 028 at	22,80

flIX

Ø28

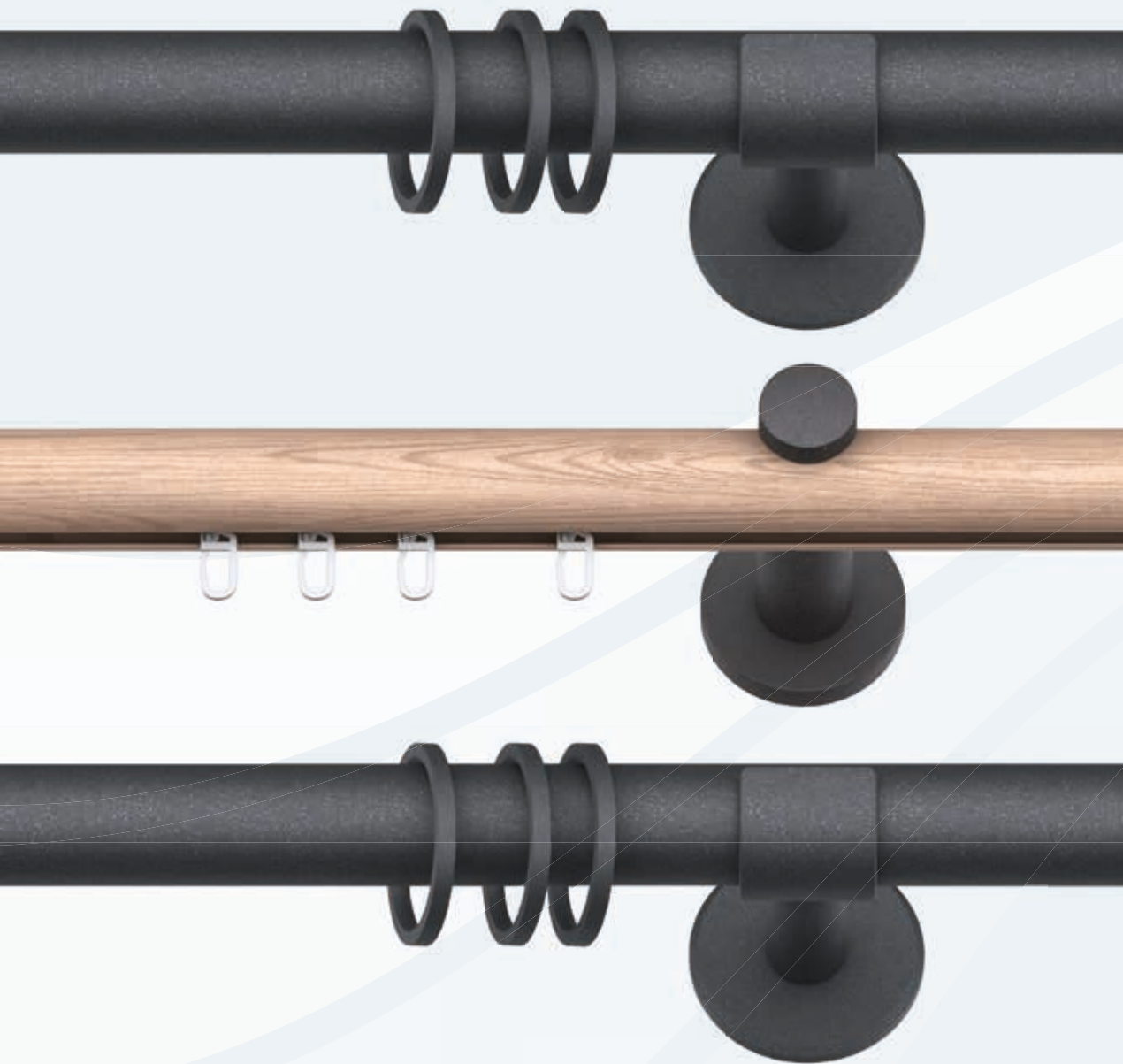

Iron Design
Ø28

Träger-
systeme

Iron Design Ø28mm Trägersysteme

Iron Design Ø28 mm - Trägersysteme



Innenlauf-Wandträger

Seite 319

Farben Zubehör

Farben Stangen



Innenlauf-Deckenträger

Seite 319

Farben Zubehör

Farben Stangen

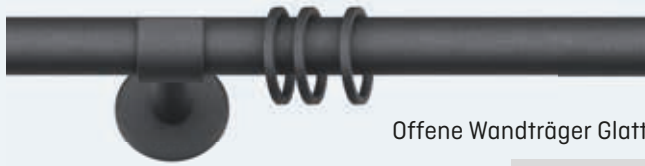

Offene Wandträger Glatt

Seite 323

Farben Zubehör & Stangen



Erkerausführung

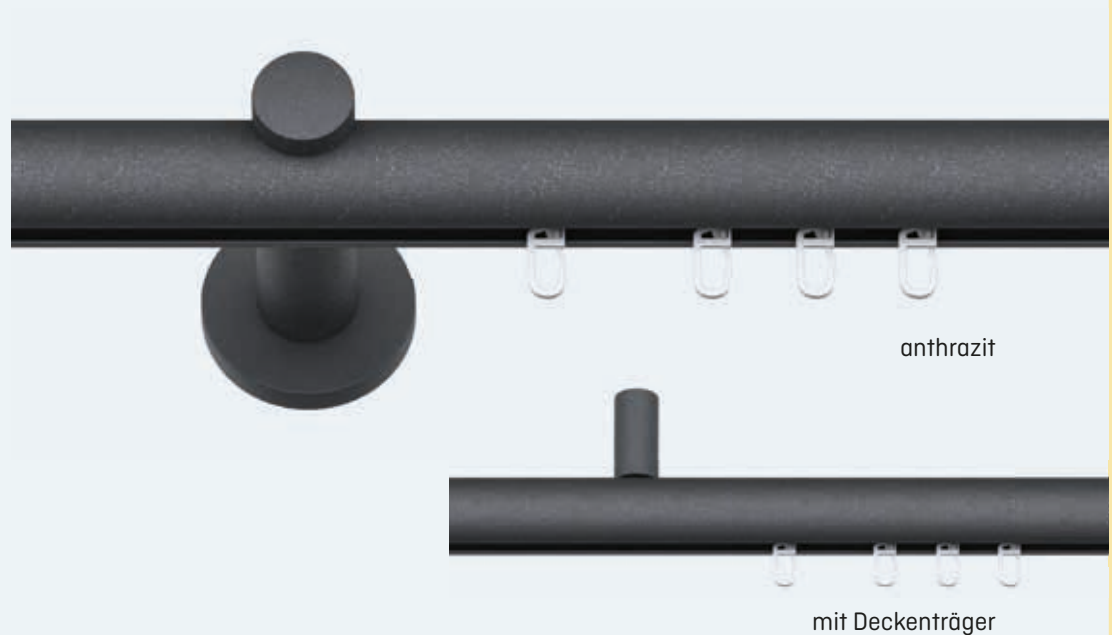

Iron Design
Ø28

Träger-
systeme

Farben Zubehör



anthrazit

Farben Innenlauf-Profile



anthrazit



wildeiche



zwetschke

Innenlauf-Wandträger Innenlauf-Deckenträger

Garnituren mit Innenlaufwand-/deckenträger ohne Endknöpfe



anthrazit
Maßstab 1:1



anthrazit
mit Deckenträger 871 077
Maßstab 1:1

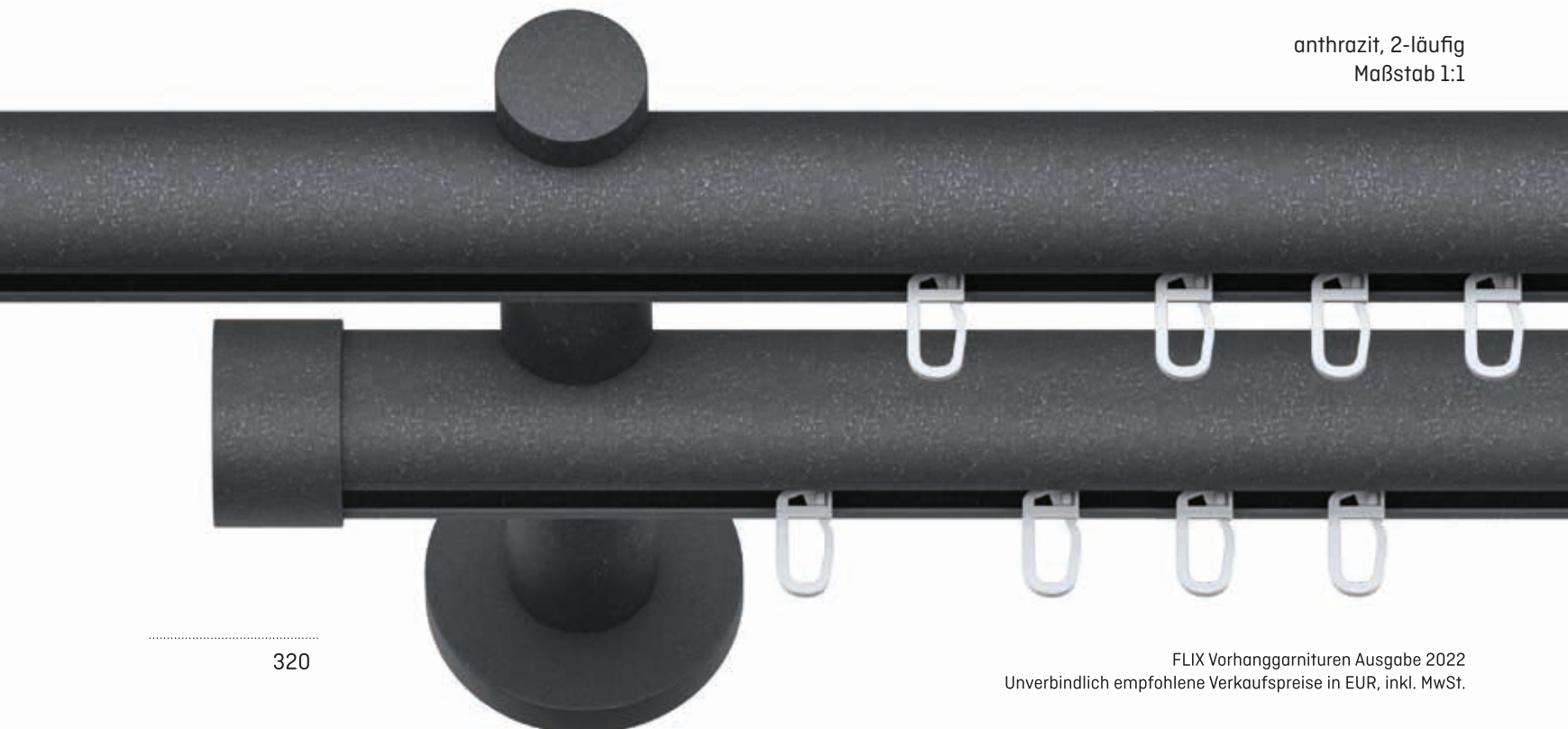

anthrazit, 2-läufig
Maßstab 1:1

Lieferumfang

- ▶ **1 lfg:** 1 Alu Innenlauf-Profil Ø28mm oberflächenbehandelt, je nach Länge Wandträger und Laufroller 2420 lt. Liste
- ▶ **2 lfg:** 2 Alu Innenlauf-Profile Ø28mm oberflächenbehandelt, je nach Länge Wandträger und Laufroller 2420 lt. Liste, 2 Endkappen
- ▶ **1 lfg mit Deckenträger 15mm Deckenabstand**
- ▶ **1 lfg mit Deckenträger 35mm Deckenabstand**
- ▶ **1 lfg mit Deckenträger 43mm Deckenabstand**
- ▶ **Deckenträger:** 1 Alu Innenlauf-Profil Ø28mm oberflächenbehandelt, je nach Länge Deckenträger und Laufroller 2420 lt. Liste

- ▶ mit Montagematerial
- ▶ Bestellmaß = Profilmaß
- ▶ Wandträger: Trägermitte bis Innenlaufprofil-Unterkante: 28mm
- ▶ bei geänderter Ausführung Aufpreis bzw. Preisänderung

Trägermaße

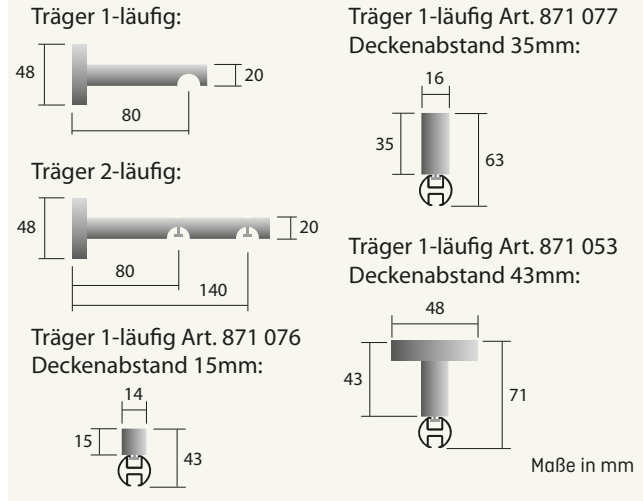



▶ **Aus produktionstechnischen Gründen bestehen geringfügige Farbabweichungen zwischen den Karniesenkomponenten.**

			anthrazit					Preisänderung für IL-Profil in:
			Wandträger		Deckenträger			
Bestellcode:			t28-201	t28-202	t28-301	t28-302	t28-303	
Länge (cm)	Wand-träger	Gleiter 1l./2l.	1lfg	2lfg	1lfg	1lfg	1lfg	1lfg
100	2	16/32	170	300	99	111	139	0
120	2	18/36	181	322	110	122	150	0
140	2	22/44	192	344	121	133	161	0
160	2	26/52	203	366	132	144	172	0
180	2	28/54	214	388	143	155	183	0
200	2	32/64	225	410	154	166	194	0
220	2	34/68	236	432	165	177	205	0
240	3	38/76	304	525	198	215	258	0
260	3	42/84	315	547	209	226	269	0
280	3	44/88	326	569	220	237	280	0
300	3	48/96	337	591	231	248	291	0
320	3	50/100	348	613	242	259	302	0
340	3	54/108	359	635	253	270	313	0
360	3	58/116	370	657	264	281	324	0
380	3	60/120	381	679	275	292	335	0
400	3	64/128	392	701	286	303	346	0
+ 20 cm ▲		3/6	11	22	11	11	11	0
Preisänderung bei Wandlager	1-seitig		-13,00	-6,00				
	2-seitig		-26,00	-12,00				

▲ ab einer Länge von ca. 420 cm bzw. bei schwereren Vorhängen wird ein weiterer Träger empfohlen (Aufpreis)

Iron Design
Ø28

Träger-systeme

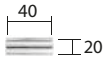
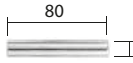
Träger und passende Verlängerungen			
Wandträger 1lfg - Wandabstand 80mm Stück			
	anthrazit	871 058 at	58,80
Wandträger 2lfg - Wandabstand 80/140mm Stück			
	anthrazit	871 143 at	74,40
Trägerverlängerung 40mm Stück			
	anthrazit	871 040 at	25,20
Trägerverlängerung 80mm Stück			
	anthrazit	871 060 at	30,-

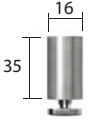
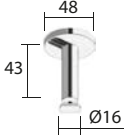
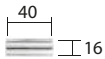
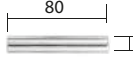
Träger und passende Verlängerungen			
Deckenträger, Deckenabstand 35mm Stück			
	anthrazit	871 077 at	28,80
Deckenträger 1lfg., Deckenabstand 43mm/Ø16mm Stück			
	anthrazit	871 053 at	43,20
Trägerverlängerung für Deckenträger, 40mm Stück			
	anthrazit	871 044 at	21,60
Trägerverlängerung für Deckenträger, 80mm Stück			
	anthrazit	871 066 at	24,-

Deckenträger, Deckenabstand 15mm Stück			
	anthrazit	871 076 at	22,80
Endkappe Ø28mm Stück			
	anthrazit	830 028 at	22,80
Endkappe flächenbündig Anna Ø28mm Stück			
	anthrazit	831 428 at	34,80

Wandlager Ø28mm Stück			
	anthrazit	823 28 at	45,60
Alu Innenlauf-Profil Ø28mm, Stange 6m Meter			
	anthrazit	n90 628 at	58,-
	wildeiche	n90 628 wi	55,20
	zwetschke	n90 628 zw	55,20
Profilverbinder Messing Stück			
	vernickelt	904 071	12,-
Profilverbinder Messing, beliebiger Winkel Stück			
	vernickelt	904 072 - bw	28,80
Gehungsschnitt (ohne Profilverbinder) Gehung			
	90°	1bg-1gs-90	20,-
	beliebiger Winkel	1bg-1gs-bw	49,-
Roller mit Faltenleghaken Stück			
	Kunststoff weiß	2420	0,20
Gleiter 100 Stück Beutel			
	Kunststoff weiß	3942 100	5,40
Roller mit Kugellager Stück			
	Kunststoff	904 074	1,10

 Biegungen siehe Gruppe 10



IRON

Ø28

Erkerausführung



Biegung



Gehrung



Gelenk

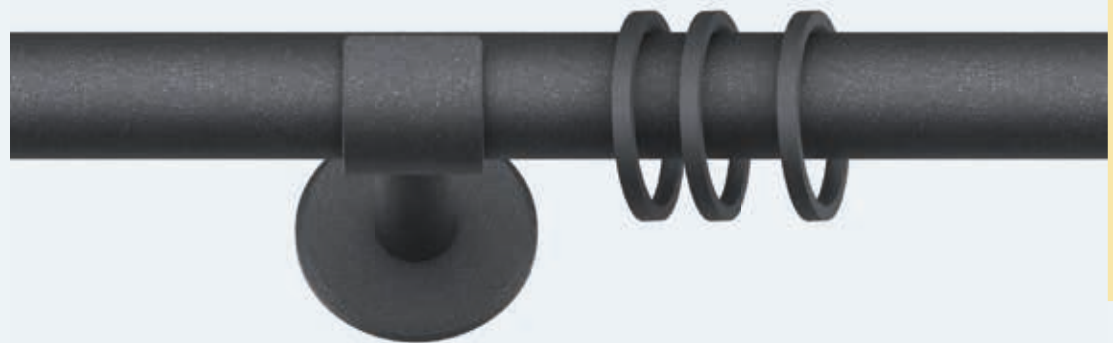

Iron Design
Ø28

Träger-
systeme

Farben Zubehör & Stangen



anthrazit

Offene Wandträger Glatt

Garnituren mit Offenen Wandträgern Glatt ohne Endknöpfe

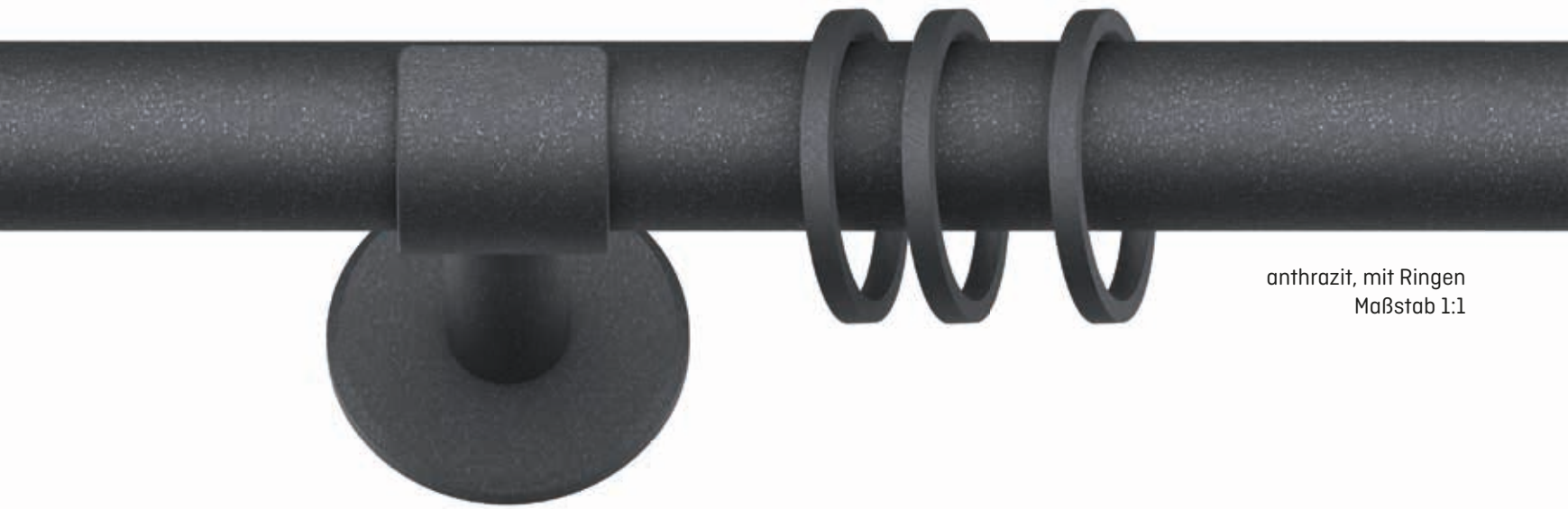

anthrazit, mit Ringen
Maßstab 1:1

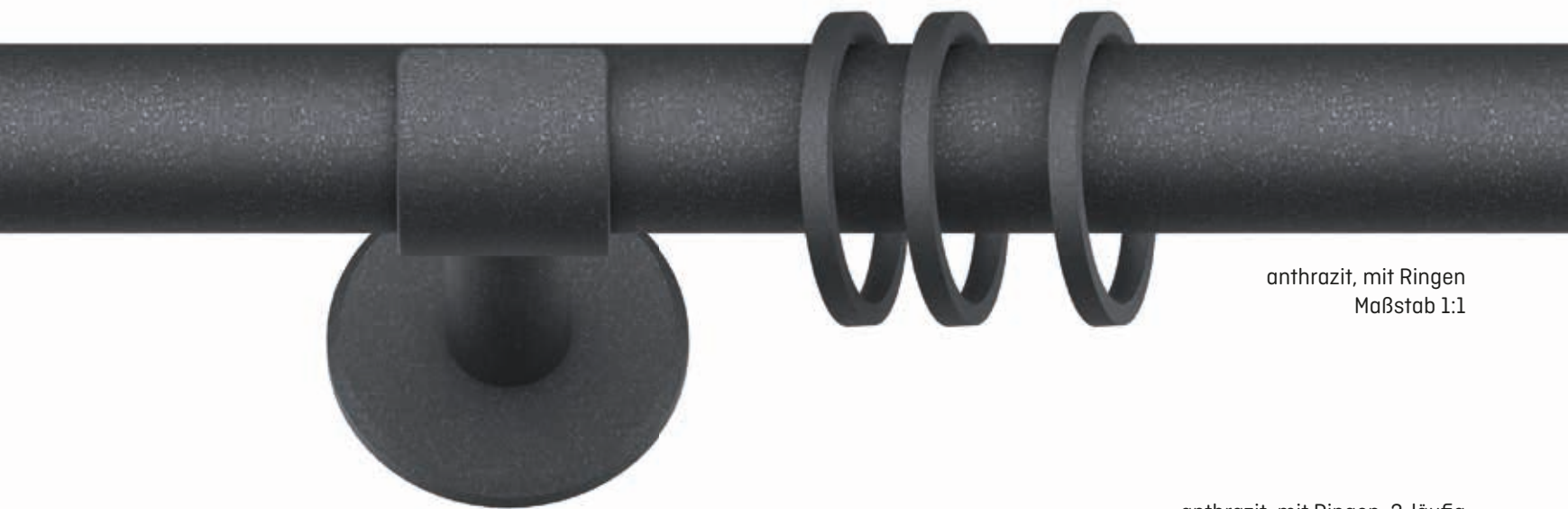

anthrazit, mit Ringen
Maßstab 1:1

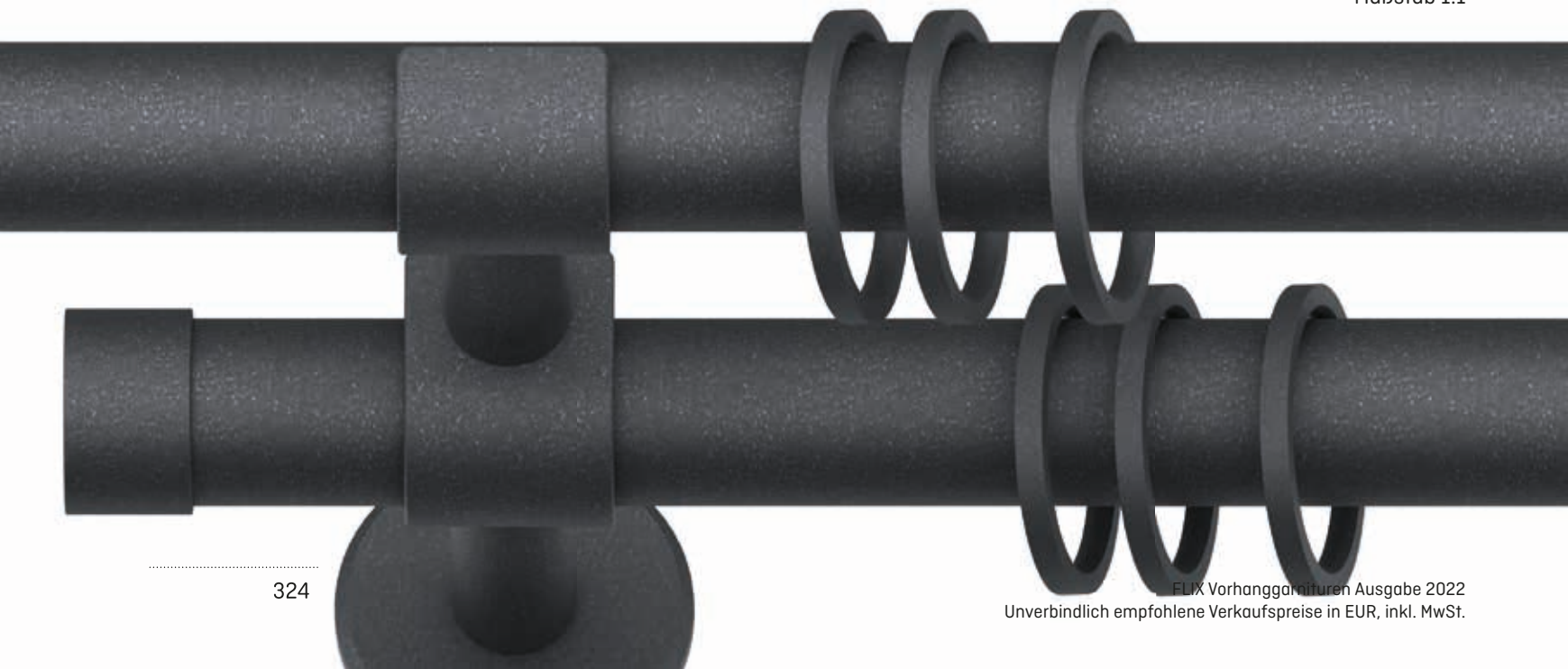

anthrazit, mit Ringen, 2-läufig
Maßstab 1:1

Lieferumfang

- ▶ **1 lfg:** 1 Aluminium-Rohr Ø28mm oberflächenbehandelt, je nach Länge Wandträger und Flachringe mit Kunststoffeinlage mit Faltenleghaken lt. Liste
 - ▶ **2 lfg:** 2 Aluminiumrohre Ø28mm oberflächenbehandelt, je nach Länge Wandträger, Flachringe mit Kunststoffeinlage mit Faltenleghaken lt. Liste, 2 Endkappen
- ▶ mit Montagematerial
 - ▶ Bestellmaß = Rohrmaß
 - ▶ Trägermitte bis Ringunterkante: 35mm
 - ▶ bei geänderter Ausführung Aufpreis bzw. Preisänderung
 - ▶ **Aus produktionstechnischen Gründen bestehen geringfügige Farbabweichungen zwischen den Karniesenkomponenten.**

Trägermaße

Träger 1-läufig:

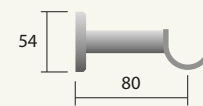

Träger 2-läufig:

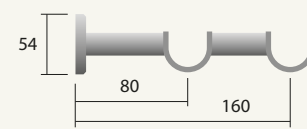

Träger 2-läufig:

Maße in mm

			anthrazit	
Bestellcode:			t28-203	t28-204
Länge (cm)	Wand-träger	Ringe/Gleiter	1lfg ○	2lfg ○○
100	2	14/16	298	549
120	2	16/18	319	592
140	2	20/22	340	635
160	2	22/26	361	678
180	2	24/28	382	721
200	2	28/32	403	764
220	2	30/34	424	807
240	3	34/38	545	986
260	3	36/42	566	1.029
280	3	38/44	587	1.072
300	3	42/48	608	1.115
320	3	44/50	629	1.158
340	3	48/54	650	1.201
360	3	50/58	671	1.244
380	3	52/60	692	1.287
400	3	56/64	713	1.330
+ 20cm ▲		3/6	21	43
Preisänderung bei Wandlager	1-seitig		-53,00	-61,00
	2-seitig		-105,00	-121,00

▲ ab einer Länge von ca. 420 cm bzw. bei schwereren Vorhängen wird ein weiterer Träger empfohlen (Aufpreis)

Iron Design
Ø28

Träger-systeme

Wandträger 1lfg - Wandabstand 80mm		Stück
	anthrazit	871 079 at 102,-
Wandträger 2lfg - Wandabstand 80/160mm		Stück
	anthrazit	871 080 at 156,-
Endkappe Ø28mm		Stück
	anthrazit	830 028 at 22,80
Endkappe flächenbündig Anna Ø28mm		Stück
	anthrazit	831 428 at 34,80
Wandlager Ø28mm		Stück
	anthrazit	82 328 at 45,60
Aluminiumrohr, Ø28mm, Stange 6m		Meter
	anthrazit	al 28 at 52,40
Rohrverbinder Ø28mm		Stück
	Metall/Kunststoff	1728 15,60
Gelenkverbinder Ø28mm		Stück
	anthrazit	8928 at 90,-
Flachring Ø28mm mit Kunststoffeinlage + FH		Stück
	anthrazit	848 281 at 4,60
Faltenleghaken		Stück
	Kunststoff glasklar	36003 gk 0,10



Holz

Holzgarnituren Ø20mm

Übersicht	Seite 330
Konische Wandträger	Seite 331
Geschlossene Wandträger.....	Seite 335

Holzgarnituren Ø28mm

Übersicht	Seite 340
Geschlossene Wandträger.....	Seite 341
Offene Wandträger.....	Seite 345

flIX

Ø20

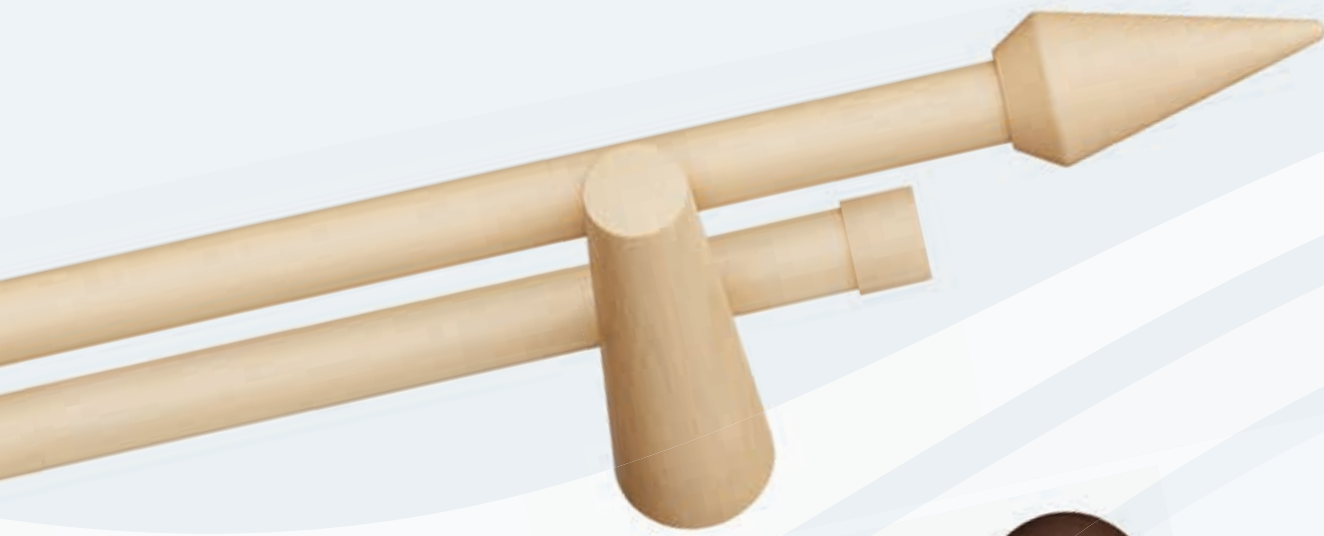

Holz
Ø20

Holzgarnituren Ø20mm

Holzgarnituren Ø20 mm



Konische Wandträger

Seite 331

Farben Zubehör & Stangen



Kim



Lena



Sarah



Irene



Geschlossene Wandträger

Seite 335

Farben Zubehör & Stangen



Andrea



Claudia



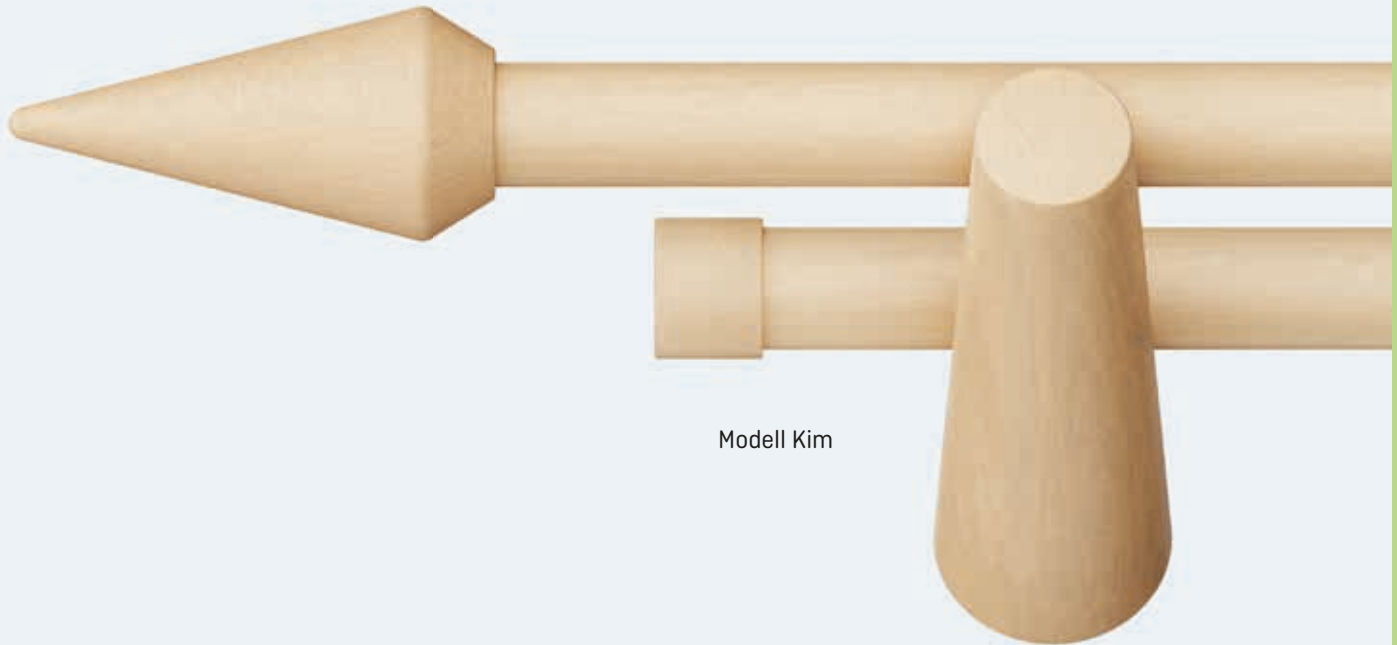

Modell Kim



Modell Lena



Modell Sarah



Modell Irene

Farben Zubehör & Stangen



natur



buche hell



kirschbaum

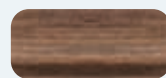

nussbaum

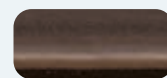

schwarz



weiß

Konische Wandträger

Komplettgarnituren mit Konische Wandträger inkl. Endknöpfe

Kim



Abb. mit Endknopf Kim
buche hell
2-läufig
Maßstab 1:1

Lena

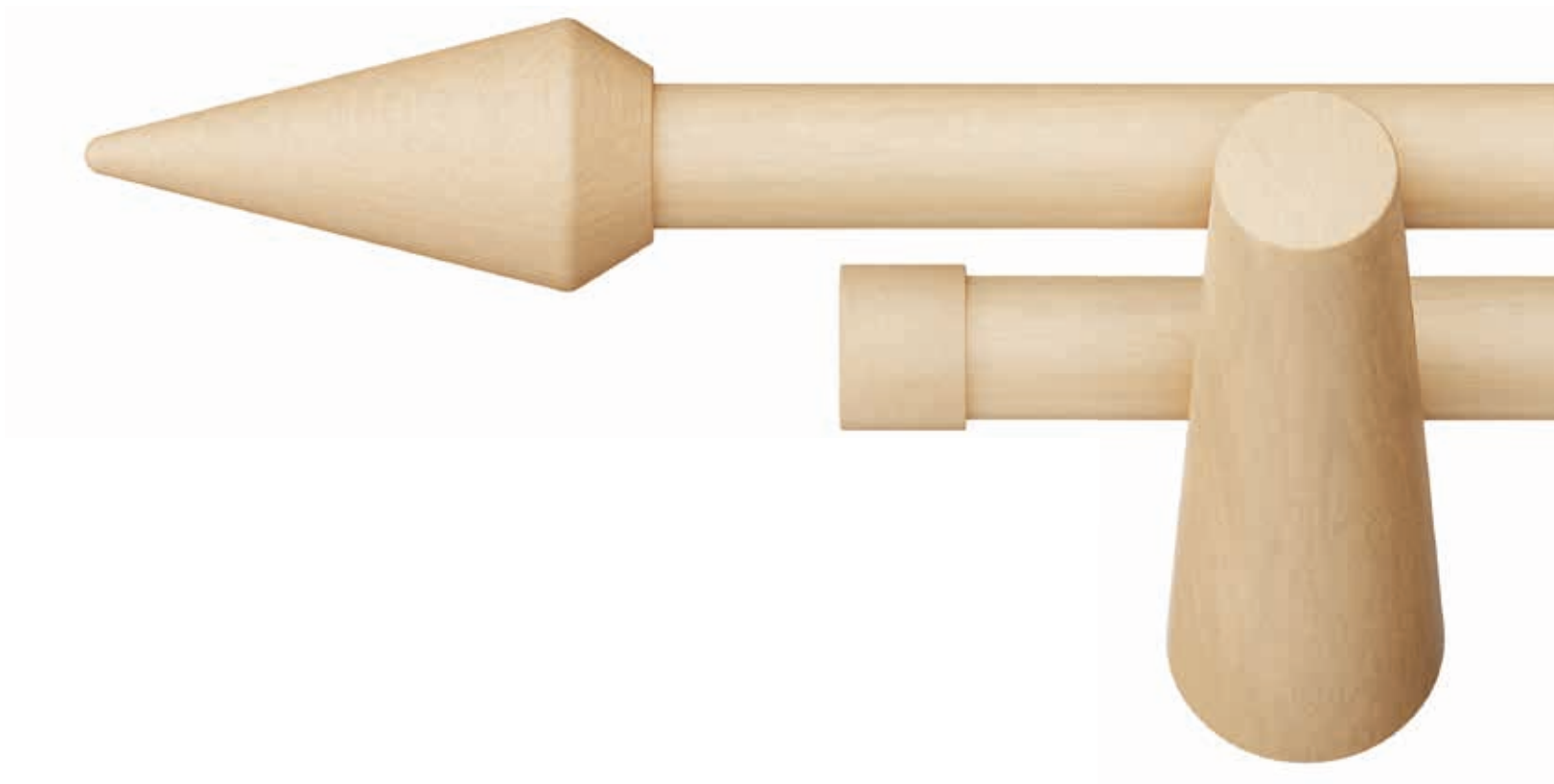

schwarz

Sarah



kirschbaum

Irene



weiß

Lieferumfang

- ▶ **1 lfg:** 1 Holzstange ● gebeizt lackiert, je nach Länge Wandträger und Ringe mit Faltenleghaken, 2 Endknöpfe
 - ▶ **2 lfg:** 2 Holzstangen ●● gebeizt lackiert, je nach Länge Wandträger und Ringe mit Faltenleghaken, 2 Endknöpfe, 2 Endkappen
- ▶ mit Montagematerial
 - ▶ Bestellmaß = Stangelänge
 - ▶ Trägermitte bis Ringunterkante: 23mm
 - ▶ bei geänderter Ausführung Aufpreis bzw. Preisabschlag
 - ▶ **Aus produktionstechnischen Gründen bestehen geringfügige Farbabweichungen zwischen den Karniesenkomponenten.**

Trägermaße

Träger 1-läufig:

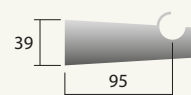

Träger 2-läufig:

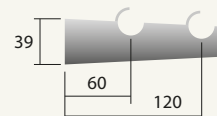

Maße in mm

			natur		buche hell		kirschbaum		nussbaum		schwarz		weiß	
Bestellcode:	Kim	kim-01	kim-02	kim-03	kim-04	kim-05	kim-06	kim-15	kim-16	kim-07	kim-08	kim-09	kim-10	
	Lena	len-01	len-02	len-03	len-04	len-05	len-06	len-15	len-16	len-07	len-08	len-09	len-10	
	Sarah	sar-01	sar-02	sar-03	sar-04	sar-05	sar-06	sar-15	sar-16	sar-07	sar-08	sar-09	sar-10	
	Irene	ire-01	ire-02	ire-03	ire-04	ire-05	ire-06	ire-15	ire-16	ire-07	ire-08	ire-09	ire-10	
Länge (cm)	Wand-träger	Ringe 1l./2l.	1lfg ●	2lfg ●●	1lfg ●	2lfg ●●	1lfg ●	2lfg ●●	1lfg ●	2lfg ●●	1lfg ●	2lfg ●●	1lfg ●	2lfg ●●
100	2	14/28	79	124	79	124	79	124	79	124	79	124	79	124
120	2	16/32	84	135	84	135	84	135	84	135	84	135	84	135
140	2	20/40	89	146	89	146	89	146	89	146	89	146	89	146
160	2	22/44	94	157	94	157	94	157	94	157	94	157	94	157
180	2	24/48	99	168	99	168	99	168	99	168	99	168	99	168
200	2	28/56	104	179	104	179	104	179	104	179	104	179	104	179
220	3	30/60	124	203	124	203	124	203	124	203	124	203	124	203
240	3	34/68	129	214	129	214	129	214	129	214	129	214	129	214
260	3	36/72	134	225	134	225	134	225	134	225	134	225	134	225
280	3	38/76	139	236	139	236	139	236	139	236	139	236	139	236
300	3	42/84	144	247	144	247	144	247	144	247	144	247	144	247
320	3	44/88	149	258	149	258	149	258	149	258	149	258	149	258
340	3	48/96	154	269	154	269	154	269	154	269	154	269	154	269
360	3	50/100	159	280	159	280	159	280	159	280	159	280	159	280
380	3	52/104	164	291	164	291	164	291	164	291	164	291	164	291
400	4	56/112	186	315	186	315	186	315	186	315	186	315	186	315
+20cm ▲		3/6	5	11	5	11	5	11	5	11	5	11	5	11
Preisabschlag bei Wandlager	1-seitig		-12,10	-7,30	-12,10	-7,30	-12,10	-7,30	-12,10	-7,30	-12,10	-7,30	-12,10	-7,30
	2-seitig		-24,10	-14,50	-24,10	-14,50	-24,10	-14,50	-24,10	-14,50	-24,10	-14,50	-24,10	-14,50

▲ ab einer Länge von ca. 580 cm bzw. bei schwereren Vorhängen wird ein weiterer Träger empfohlen (Aufpreis)

Wandträger Holz 1lfg - Wandabstand 95mm			Stück
	natur	710 230 na	14,10
	buche hell	710 230 bu	14,10
	kirschbaum	710 230 kr	14,10
	nussbaum	710 230 nu	14,10
	schwarz	710 230 sw	14,10
	weiß	710 230 we	14,10

Endknopf Kim Holz Ø20mm			Stück
	natur	730 421 na	8,20
	buche hell	730 421 bu	8,20
	kirschbaum	730 421 kr	8,20
	nussbaum	730 421 nu	8,20
	schwarz	730 421 sw	8,20
	weiß	730 421 we	8,20

Wandträger Holz 2lfg - Wandabstand 60/120mm			Stück
	natur	710 231 na	16,70
	buche hell	710 231 bu	16,70
	kirschbaum	710 231 kr	16,70
	nussbaum	710 231 nu	16,70
	schwarz	710 231 sw	16,70
	weiß	710 231 we	16,70

Endknopf Lena Holz Ø20mm			Stück
	natur	730 320 na	8,20
	buche hell	730 320 bu	8,20
	kirschbaum	730 320 kr	8,20
	nussbaum	730 320 nu	8,20
	schwarz	730 320 sw	8,20
	weiß	730 320 we	8,20

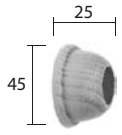
Wandlager Holz Ø20mm			Stück
	natur	720 20 na	9,60
	buche hell	720 20 bu	9,60
	kirschbaum	720 20 kr	9,60
	nussbaum	720 20 nu	9,60
	schwarz	720 20 sw	9,60
	weiß	720 20 we	9,60

Endknopf Sarah Holz Ø20mm			Stück
	natur	730 520 na	8,20
	buche hell	730 520 bu	8,20
	kirschbaum	730 520 kr	8,20
	nussbaum	730 520 nu	8,20
	schwarz	730 520 sw	8,20
	weiß	730 520 we	8,20

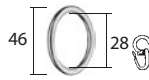
Holz-Ring Ø20mm + FH			Stück
	natur	740 201 na	0,65
	buche hell	740 201 bu	0,65
	kirschbaum	740 201 kr	0,65
	nussbaum	740 201 nu	0,65
	schwarz	740 201 sw	1,-
	weiß	740 201 we	1,-

Endkappe/Endknopf Irene Holz Ø20mm			Stück
	natur	731 220 na	8,20
	buche hell	731 220 bu	8,20
	kirschbaum	731 220 kr	8,20
	nussbaum	731 220 nu	8,20
	schwarz	731 220 sw	8,20
	weiß	731 220 we	8,20

Holzstange Ø20mm, Stange ca. 4,2m			Meter
	natur	sk201 na	17,90
	buche hell	sk201 bu	17,90
	kirschbaum	sk201 kr	17,90
	nussbaum	sk201 nu	17,90
	schwarz	sk201 sw	17,90
	weiß	sk201 we	17,90

Faltenleghaken für Holz-Ring			Stück
	Kunststoff glasklar	36008 gk	0,10

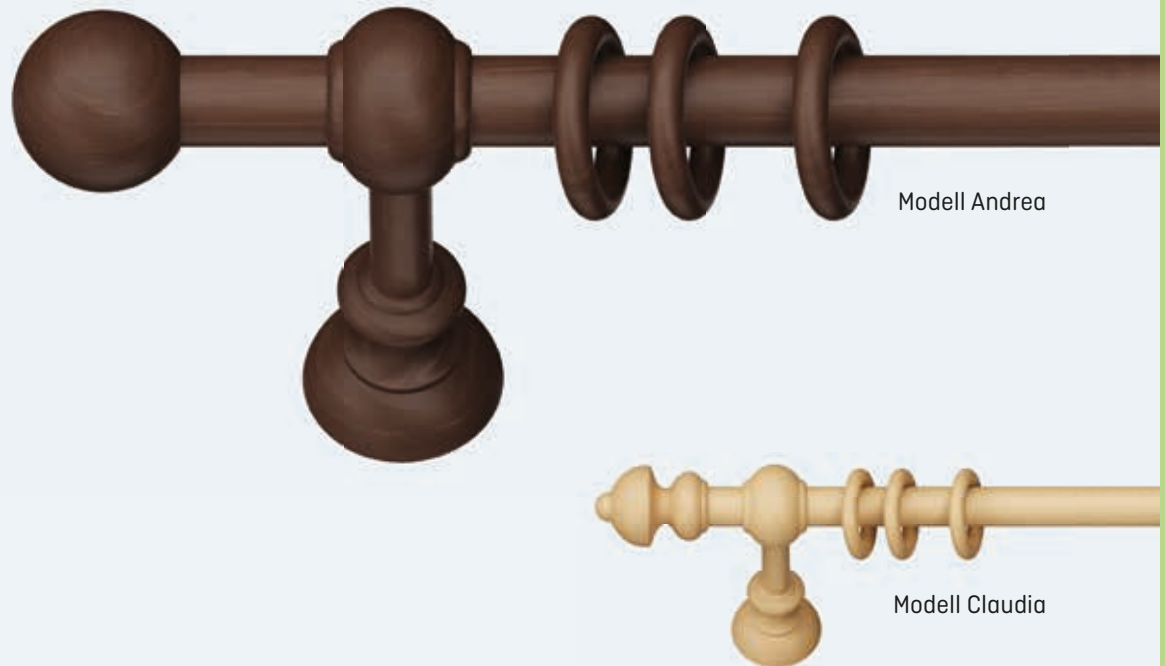

Modell Andrea

Modell Claudia

Farben Zubehör & Stangen

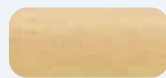

natur



nussbaum



schwarz



weiß

Geschlossene Wandträger

Komplettgarnituren mit Geschlossene Wandträger inkl. Endknöpfe



Abb. Andrea nussbaum
Maßstab 1:1



Abb. Claudia natur
Maßstab 1:1

Lieferumfang

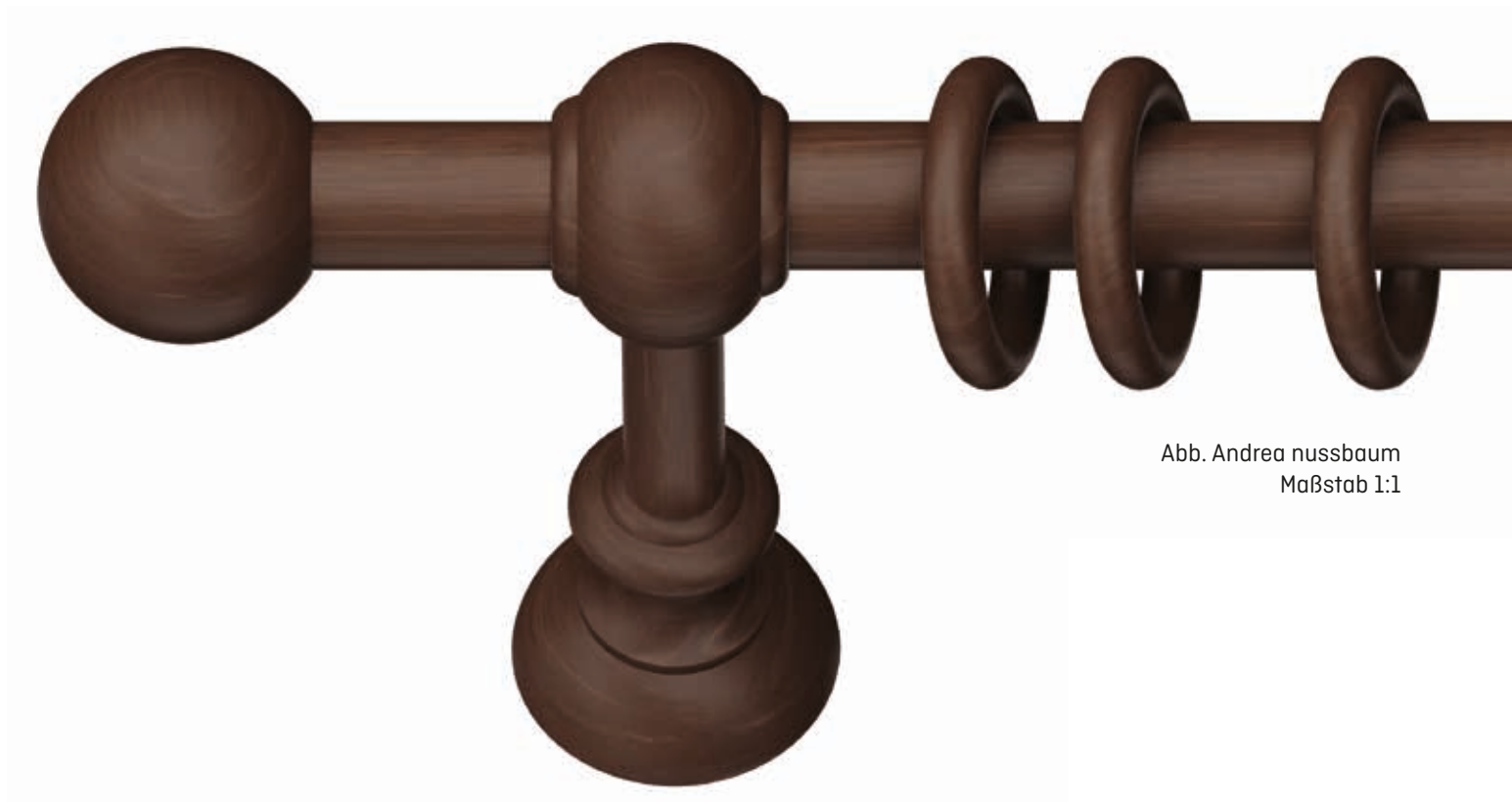
▶ **1 lfg:** 1 Holzstange ● gebeizt lackiert Ø20mm, je nach Länge Wandträger und Ringe mit Faltenleghaken, 2 Endknöpfe



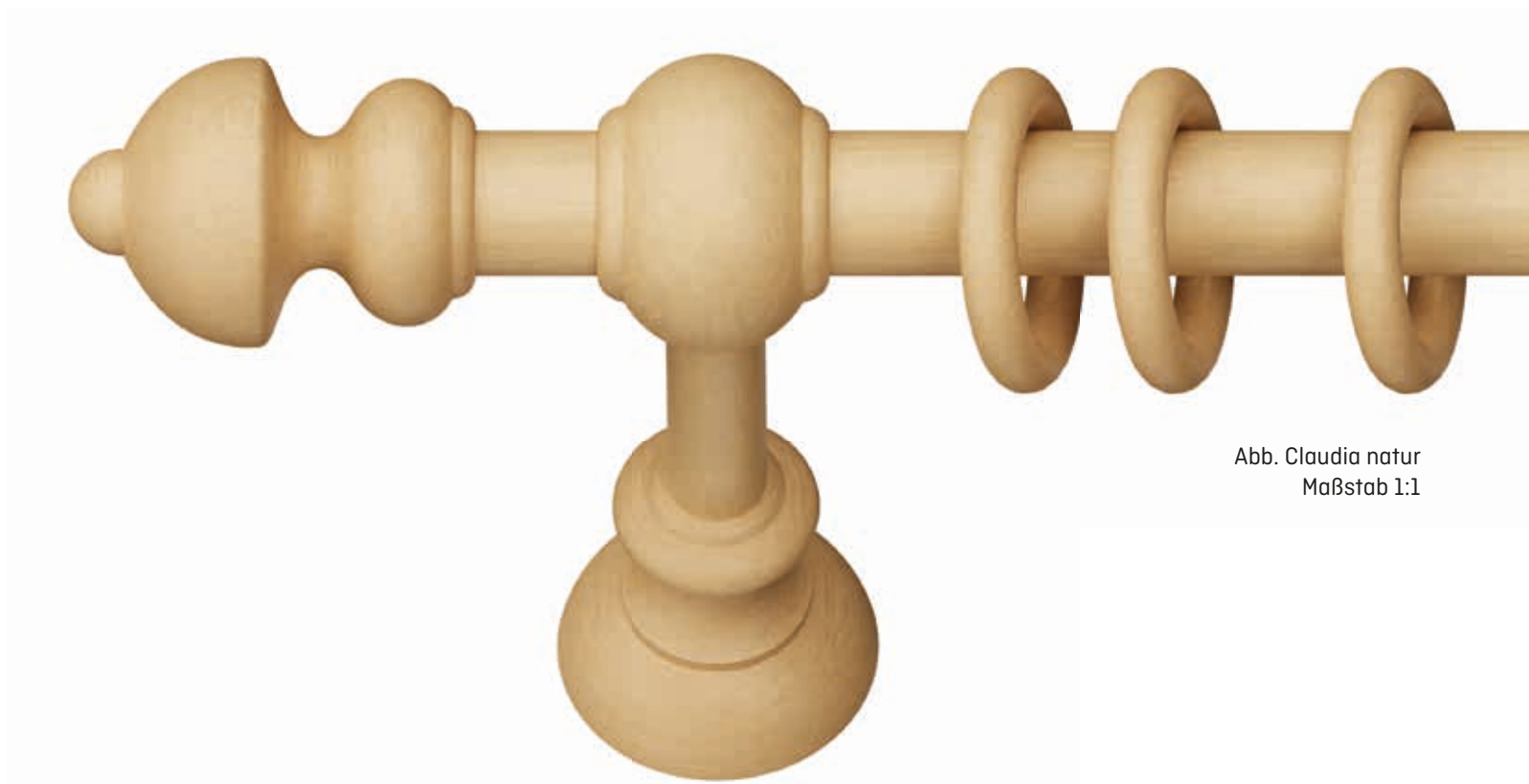

- ▶ mit Montagematerial
- ▶ Bestellmaß = Stangenmaß
- ▶ Trägermitte bis Ringunterkante: 24mm
- ▶ bei geänderter Ausführung Aufpreis bzw. Preisabschlag
- ▶ **Aus produktionstechnischen Gründen bestehen geringfügige Farbabweichungen zwischen den Karniesenkomponenten.**

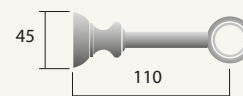
Trägermaße

Träger 1-läufig:



Maße in mm

						
			natur	nussbaum	schwarz	weiß
Bestellcode:	Andrea		and-01	and-03	and-05	and-07
	Claudia		cla-01	cla-03	cla-05	cla-07
Länge (cm)	Wand-träger	Ringe 1fg	1fg ●	1fg ●	1fg ●	1fg ●
100	2	14	61	61	63	63
120	2	16	66	66	69	69
140	2	20	71	71	75	75
160	2	22	76	76	81	81
180	2	24	81	81	87	87
200	2	28	86	86	93	93
220	3	30	103	103	107	107
240	3	34	108	108	113	113
260	3	36	113	113	119	119
280	3	38	118	118	125	125
300	3	42	123	123	131	131
320	3	44	128	128	137	137
340	3	48	133	133	143	143
360	3	50	138	138	149	149
380	3	52	143	143	155	155
400	4	56	162	162	169	169
+ 20cm ▲		3	5	5	6	6
Preisabschlag	1-seitig		-12,10	-12,10	-12,10	-12,10
bei Wandlager	2-seitig		-24,10	-24,10	-24,10	-24,10

▲ ab einer Länge von ca. 580 cm bzw. bei schwereren Vorhängen wird ein weiterer Träger empfohlen (Aufpreis)

Träger kürzen ohne Aufpreis

Träger 1-läufig:



kürzbar um max. 40 mm

Wandträger Holz 1lfg - Wandabstand 100mm			Stück
	natur	710 120 na	10,70
	nussbaum	710 120 nu	10,70
	schwarz	710 120 sw	10,70
	weiß	710 120 we	10,70

Endknopf Andrea Holz Ø20mm			Stück
	natur	730 520 na	8,20
	nussbaum	730 520 nu	8,20
	schwarz	730 520 sw	8,20
	weiß	730 520 we	8,20

Endkappe Holz Ø20mm			Stück
	natur	731 220 na	8,20
	nussbaum	731 220 nu	8,20
	schwarz	731 220 sw	8,20
	weiß	731 220 we	8,20

Endknopf Claudia Holz Ø20mm			Stück
	natur	730 120 na	8,20
	nussbaum	730 120 nu	8,20
	schwarz	730 120 sw	8,20
	weiß	730 120 we	8,20

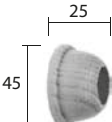
Wandlager Holz Ø20mm			Stück
	natur	720 20 na	9,60
	nussbaum	720 20 nu	9,60
	schwarz	720 20 sw	9,60
	weiß	720 20 we	9,60

Holz-Ring Ø20mm + FH			Stück
	natur	740 201 na	0,65
	nussbaum	740 201 nu	0,65
	schwarz	740 201 sw	1,-
	weiß	740 201 w	1,-

Holzstange Ø20mm, Stange ca. 4,2m			Meter
	natur	sk201 na	17,90
	nussbaum	sk201 nu	17,90
	schwarz	sk201 sw	17,90
	weiß	sk201 w	17,90

Faltenleghaken für Holz-Ring			Stück
	Kunststoff glasklar	36008 gk	0,10

flIX

Ø28



Holz
Ø28

Holzgarnituren Ø28mm

Holzgarnituren Ø28 mm



Farben Zubehör & Stangen



Farben Zubehör & Stangen





Modell Simone

Modell Marina

Farben Zubehör & Stangen



natur



buche hell



kirschbaum

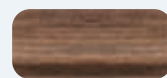

nussbaum



weiß

Geschlossene Wandträger

Komplettgarnituren mit Geschlossene Wandträger inkl. Endknöpfe



Abb. Simone nussbaum
Maßstab 1:1

Marina



Burgi



Betty



Bea



Pia



Lieferumfang

- ▶ **1 lfg:** 1 Holzstange Ø28mm, je nach Länge Wandträger und Ringe mit Faltenleghaken, 2 Endknöpfe
- ▶ **2 lfg:** 2 Holzstangen Ø28mm, je nach Länge Wandträger und Ringe mit Faltenleghaken, 2 Endknöpfe, 2 Endkappen

- ▶ mit Montagematerial
- ▶ Bestellmaß = Stangenmaß
- ▶ Trägermitte bis Ringunterkante: 32mm
- ▶ bei geänderter Ausführung Aufpreis bzw. Preisabschlag
- ▶ **Aus produktionstechnischen Gründen bestehen geringfügige Farbabweichungen zwischen den Karniesenkomponenten.**

Trägermaße

Träger 1-läufig:



Träger 2-läufig:

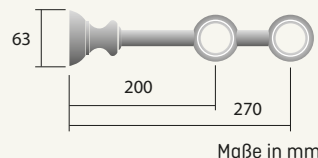

Maße in mm

			natur	buche hell	kirschbaum	nussbaum	weiß					
Bestellcode:	Simone	sim-30	sim-31	sim-32	sim-33	sim-34	sim-35	sim-36	sim-37	sim-38	sim-39	
	Marina	mar-30	mar-31	mar-32	mar-33	mar-34	mar-35	mar-36	mar-37	mar-38	mar-39	
	Betty	bet-30	bet-31	bet-32	bet-33	bet-34	bet-35	bet-36	bet-37	bet-38	bet-39	
	Burgi	bur-30	bur-31	bur-32	bur-33	bur-34	bur-35	bur-36	bur-37	bur-38	bur-39	
	Bea	bea-30	bea-31	bea-32	bea-33	bea-34	bea-35	bea-36	bea-37	bea-38	bea-39	
	Pia	pia-30	pia-31	pia-32	pia-33	pia-34	pia-35	pia-36	pia-37	pia-38	pia-39	
Länge (cm)	Wand-träger	Ringe 1l./2l.	1lfg ●	2lfg ●●	1lfg ●	2lfg ●●	1lfg ●	2lfg ●●	1lfg ●	2lfg ●●	1lfg ●	2lfg ●●
100	2	14/28	98	169	98	169	98	169	98	169	101	180
120	2	16/32	105	183	105	183	105	183	105	183	109	196
140	2	20/40	112	197	112	197	112	197	112	197	117	212
160	2	22/44	119	211	119	211	119	211	119	211	125	228
180	2	24/48	126	225	126	225	126	225	126	225	133	244
200	2	28/56	133	239	133	239	133	239	133	239	141	260
220	2	30/60	140	253	140	253	140	253	140	253	149	276
240	3	34/68	167	296	167	296	167	296	167	296	178	323
260	3	36/72	174	310	174	310	174	310	174	310	186	339
280	3	38/76	181	324	181	324	181	324	181	324	194	355
300	3	42/84	188	338	188	338	188	338	188	338	202	371
320	3	44/88	195	352	195	352	195	352	195	352	210	387
340	3	48/96	202	366	202	366	202	366	202	366	218	403
360	3	50/100	209	380	209	380	209	380	209	380	226	419
380	3	52/104	216	394	216	394	216	394	216	394	234	435
400	3	56/112	223	408	223	408	223	408	223	408	242	451
+ 20cm ▲	3/6		7	14	7	14	7	14	7	14	8	16
Preisabschlag bei Wandlager	1-seitig		-18,60	-26,20	-18,60	-26,20	-18,60	-26,20	-18,60	-26,20	-17,50	-26,20
	2-seitig		-37,20	-52,30	-37,20	-52,30	-37,20	-52,30	-37,20	-52,30	-35,00	-52,30

▲ ab einer Länge von ca. 420 cm bzw. bei schwereren Vorhängen wird ein weiterer Träger empfohlen (Aufpreis)

Träger kürzen: ohne Aufpreis



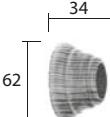

Wandträger Holz 1lfg - Wandabstand 180mm			Stück
	natur	710 128 na	20,30
	buche hell	710 128 bu	20,30
	kirschbaum	710 128 kr	20,30
	nussbaum	710 128 nu	20,30
	weiß	710 128 we	20,30

Wandträger Holz 2lfg - Wandabstand 200/270mm			Stück
	natur	710 228 na	32,40
	buche hell	710 228 bu	32,40
	kirschbaum	710 228 kr	32,40
	nussbaum	710 228 nu	32,40
	weiß	710 228 we	32,40

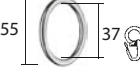
Wandlager Holz Ø28mm			Stück
	natur	720 28 na	10,70
	buche hell	720 28 bu	10,70
	kirschbaum	720 28 kr	10,70
	nussbaum	720 28 nu	10,70
	weiß	720 28 we	10,70

Holz-Ring Ø28mm + FH			Stück
	natur	740 281 na	0,95
	buche hell	740 281 bu	0,95
	kirschbaum	740 281 kr	0,95
	nussbaum	740 281 nu	0,95
	weiß	740 281 we	1,30

Holzstange Ø28mm, Stange ca. 4,2m			Meter
	natur	sk281 na	18,30
	buche hell	sk281 bu	18,30
	kirschbaum	sk281 kr	18,30
	nussbaum	sk281 nu	18,30
	weiß	sk281 we	18,30

Faltenleghaken für Ring			Stück
	Kunststoff glasklar	36010 gk	0,10

Endknopf Simone Ø28mm			Stück
	natur	730 228 na	11,70
	buche hell	730 228 bu	11,70
	kirschbaum	730 228 kr	11,70
	nussbaum	730 228 nu	11,70
	weiß	730 228 we	11,70

Endknopf Marina Ø28mm			Stück
	natur	730 428 na	11,70
	buche hell	730 428 bu	11,70
	kirschbaum	730 428 kr	11,70
	nussbaum	730 428 nu	11,70
	weiß	730 428 we	11,70

Endknopf Betty Ø28mm			Stück
	natur	730 225 na	11,70
	buche hell	730 225 bu	11,70
	kirschbaum	730 225 kr	11,70
	nussbaum	730 225 nu	11,70
	weiß	730 225 we	11,70

Endknopf Burgi Ø28mm			Stück
	natur	730 227 na	11,70
	buche hell	730 227 bu	11,70
	kirschbaum	730 227 kr	11,70
	nussbaum	730 227 nu	11,70
	weiß	730 227 we	11,70

Endknopf Bea Ø28mm			Stück
	natur	730 226 na	11,70
	buche hell	730 226 bu	11,70
	kirschbaum	730 226 kr	11,70
	nussbaum	730 226 nu	11,70
	weiß	730 226 we	11,70

Endknopf/Endkappe Pia Ø28mm			Stück
	natur	731 228 na	11,70
	buche hell	731 228 bu	11,70
	kirschbaum	731 228 kr	11,70
	nussbaum	731 228 nu	11,70
	weiß	731 228 we	11,70



Modell Burgi



Modell Betty



Modell Bea

Farben Holz: Zubehör & Stangen



natur



buche hell



kirschbaum



nussbaum



weiß

Offene Wandträger

Komplettgarnituren mit Offene Wandträger inkl. Endknöpfe



Abb. mit Endknopf Burgi
nussbaum
2-läufig
Maßstab 1:1

Simone



Marina

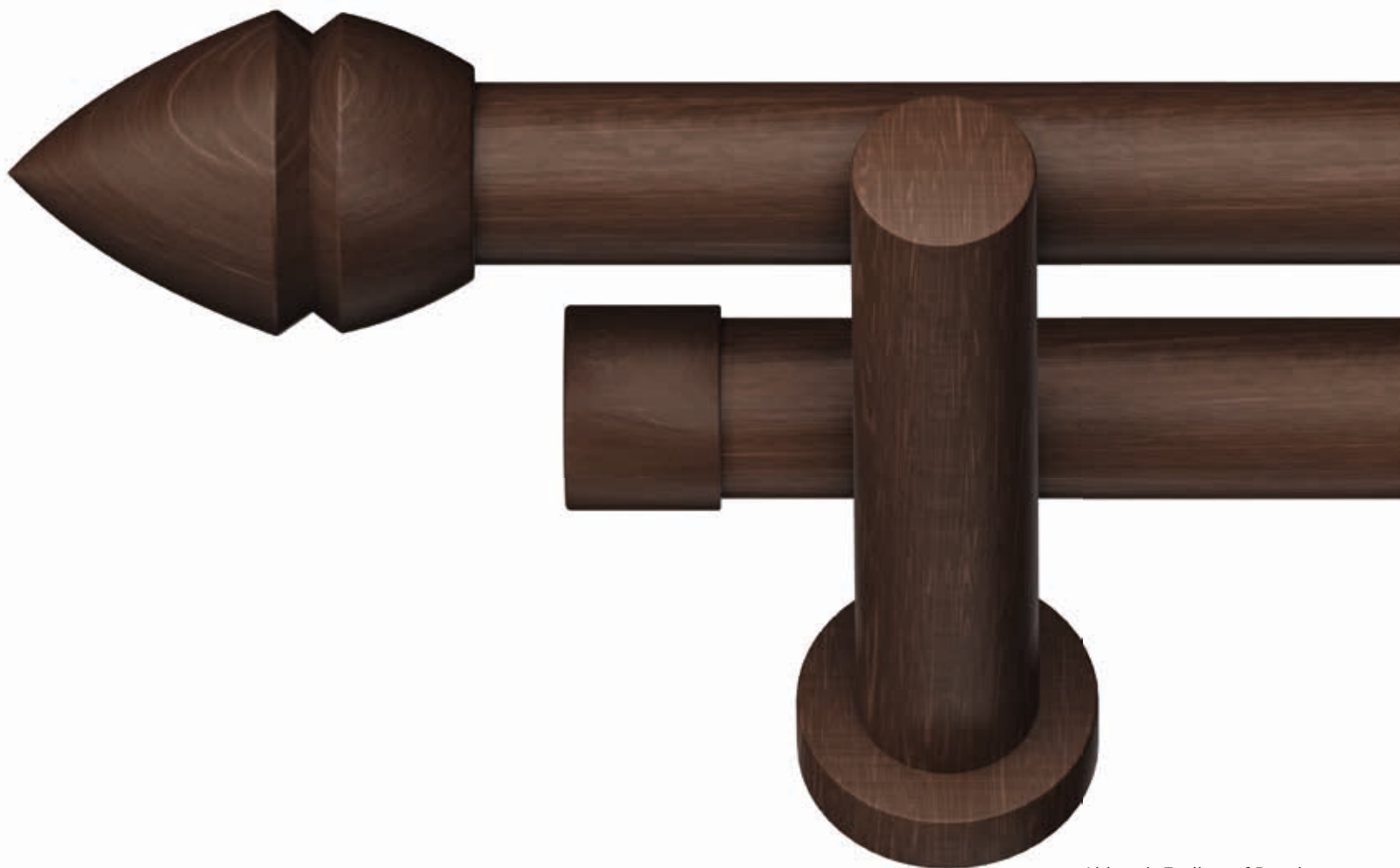

Betty



Bea



Pia



Lieferumfang

- ▶ **1 lfg:** 1 Holzstange Ø28mm, je nach Länge Wandträger und Ringe mit Faltenleghaken, 2 Endknöpfe
- ▶ **2 lfg:** 2 Holzstangen Ø28mm, je nach Länge Wandträger und Ringe mit Faltenleghaken, 2 Endknöpfe, 2 Endkappen

- ▶ mit Montagematerial
- ▶ Bestellmaß = Stangenmaß
- ▶ Trägermitte bis Ringunterkante: 32mm
- ▶ bei geänderter Ausführung Aufpreis bzw. Preisabschlag
- ▶ **Aus produktionstechnischen Gründen bestehen geringfügige Farbabweichungen zwischen den Karniesenkomponenten.**

Trägermaße

Träger 1-läufig:

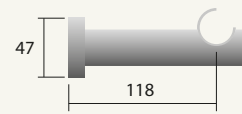

Träger 2-läufig:

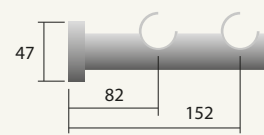

Maße in mm

			natur		buche hell		kirschbaum		nussbaum		weiß	
Bestellcode:	Simone	sim-40	sim-41	sim-42	sim-43	sim-44	sim-45	sim-46	sim-47	sim-48	sim-49	
	Marina	mar-40	mar-41	mar-42	mar-43	mar-44	mar-45	mar-46	mar-47	mar-48	mar-49	
	Betty	bet-40	bet-41	bet-42	bet-43	bet-44	bet-45	bet-46	bet-47	bet-48	bet-49	
	Burgi	bur-40	bur-41	bur-42	bur-43	bur-44	bur-45	bur-46	bur-47	bur-48	bur-49	
	Bea	bea-40	bea-41	bea-42	bea-43	bea-44	bea-45	bea-46	bea-47	bea-48	bea-49	
	Pia	pia-40	pia-41	pia-42	pia-43	pia-44	pia-45	pia-46	pia-47	pia-48	pia-49	
Länge (cm)	Wand-träger	Ringe 1l./2l.	1lfg	2lfg	1lfg	2lfg	1lfg	2lfg	1lfg	2lfg	1lfg	2lfg
100	2	14/28	98	148	98	148	98	148	98	148	104	160
120	2	16/32	104	161	104	161	104	161	104	161	112	176
140	2	20/40	110	174	110	174	110	174	110	174	120	192
160	2	22/44	116	187	116	187	116	187	116	187	128	208
180	2	24/48	122	200	122	200	122	200	122	200	136	224
200	2	28/56	128	213	128	213	128	213	128	213	144	240
220	2	30/60	134	226	134	226	134	226	134	226	152	256
240	3	34/68	166	263	166	263	166	263	166	263	180	292
260	3	36/72	172	276	172	276	172	276	172	276	188	308
280	3	38/76	178	289	178	289	178	289	178	289	196	324
300	3	42/84	184	302	184	302	184	302	184	302	204	340
320	3	44/88	190	315	190	315	190	315	190	315	212	356
340	3	48/96	196	328	196	328	196	328	196	328	220	372
360	3	50/100	202	341	202	341	202	341	202	341	228	388
380	3	52/104	208	354	208	354	208	354	208	354	236	404
400	3	56/112	214	367	214	367	214	367	214	367	244	420
+20cm	▲	3/6	6	13	6	13	6	13	6	13	8	16
Preisabschlag bei Wandlager	1-seitig		-20,90	-17,90	-20,90	-17,90	-20,90	-17,90	-20,90	-17,90	-20,70	-17,60
	2-seitig		-41,80	-35,90	-41,80	-35,90	-41,80	-35,90	-41,80	-35,90	-41,40	-35,10

▲ ab einer Länge von ca. 420 cm bzw. bei schwereren Vorhängen wird ein weiterer Träger empfohlen (Aufpreis)

Holz
Ø28

Wandträger Holz 1lfg - Wandabstand 180mm Stück

	natur	710 240 na	20,30
	buche hell	710 240 bu	20,30
	kirschbaum	710 240 kr	20,30
	nussbaum	710 240 nu	20,30
	weiß	710 240 we	20,30

Wandträger Holz 2lfg - Wandabstand 82/152mm Stück

	natur	710 241 na	21,80
	buche hell	710 241 bu	21,80
	kirschbaum	710 241 kr	21,80
	nussbaum	710 241 nu	21,80
	weiß	710 241 we	21,80

Wandlager Holz Ø28mm Stück

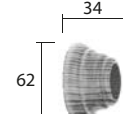
	natur	720 28 na	10,70
	buche hell	720 28 bu	10,70
	kirschbaum	720 28 kr	10,70
	nussbaum	720 28 nu	10,70
	weiß	720 28 we	10,70

Holz-Ring Ø28mm + FH Stück

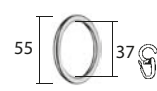
	natur	740 281 na	0,95
	buche hell	740 281 bu	0,95
	kirschbaum	740 281 kr	0,95
	nussbaum	740 281 nu	0,95
	weiß	740 281 we	1,30

Holzstange Ø28mm, Stange ca. 4,2m Meter

	natur	sk281 na	18,30
	buche hell	sk281 bu	18,30
	kirschbaum	sk281 kr	18,30
	nussbaum	sk281 nu	18,30
	weiß	sk281 we	18,30

Faltenleghaken für Ring Stück

	Kunststoff glasklar	36010 gk	0,10
--	---------------------	----------	------

Endknopf Simone Ø28mm Stück

	natur	730 228 na	11,70
	buche hell	730 228 bu	11,70
	kirschbaum	730 228 kr	11,70
	nussbaum	730 228 nu	11,70
	weiß	730 228 we	11,70

Endknopf Marina Ø28mm Stück

	natur	730 428 na	11,70
	buche hell	730 428 bu	11,70
	kirschbaum	730 428 kr	11,70
	nussbaum	730 428 nu	11,70
	weiß	730 428 we	11,70

Endknopf Betty Ø28mm Stück

	natur	730 225 na	11,70
	buche hell	730 225 bu	11,70
	kirschbaum	730 225 kr	11,70
	nussbaum	730 225 nu	11,70
	weiß	730 225 we	11,70

Endknopf Burgi Ø28mm Stück

	natur	730 227 na	11,70
	buche hell	730 227 bu	11,70
	kirschbaum	730 227 kr	11,70
	nussbaum	730 227 nu	11,70
	weiß	730 227 we	11,70

Endknopf Bea Ø28mm Stück

	natur	730 226 na	11,70
	buche hell	730 226 bu	11,70
	kirschbaum	730 226 kr	11,70
	nussbaum	730 226 nu	11,70
	weiß	730 226 we	11,70

Endknopf/Endkappe Pia Ø28mm Stück

	natur	731 228 na	11,70
	buche hell	731 228 bu	11,70
	kirschbaum	731 228 kr	11,70
	nussbaum	731 228 nu	11,70
	weiß	731 228 we	11,70

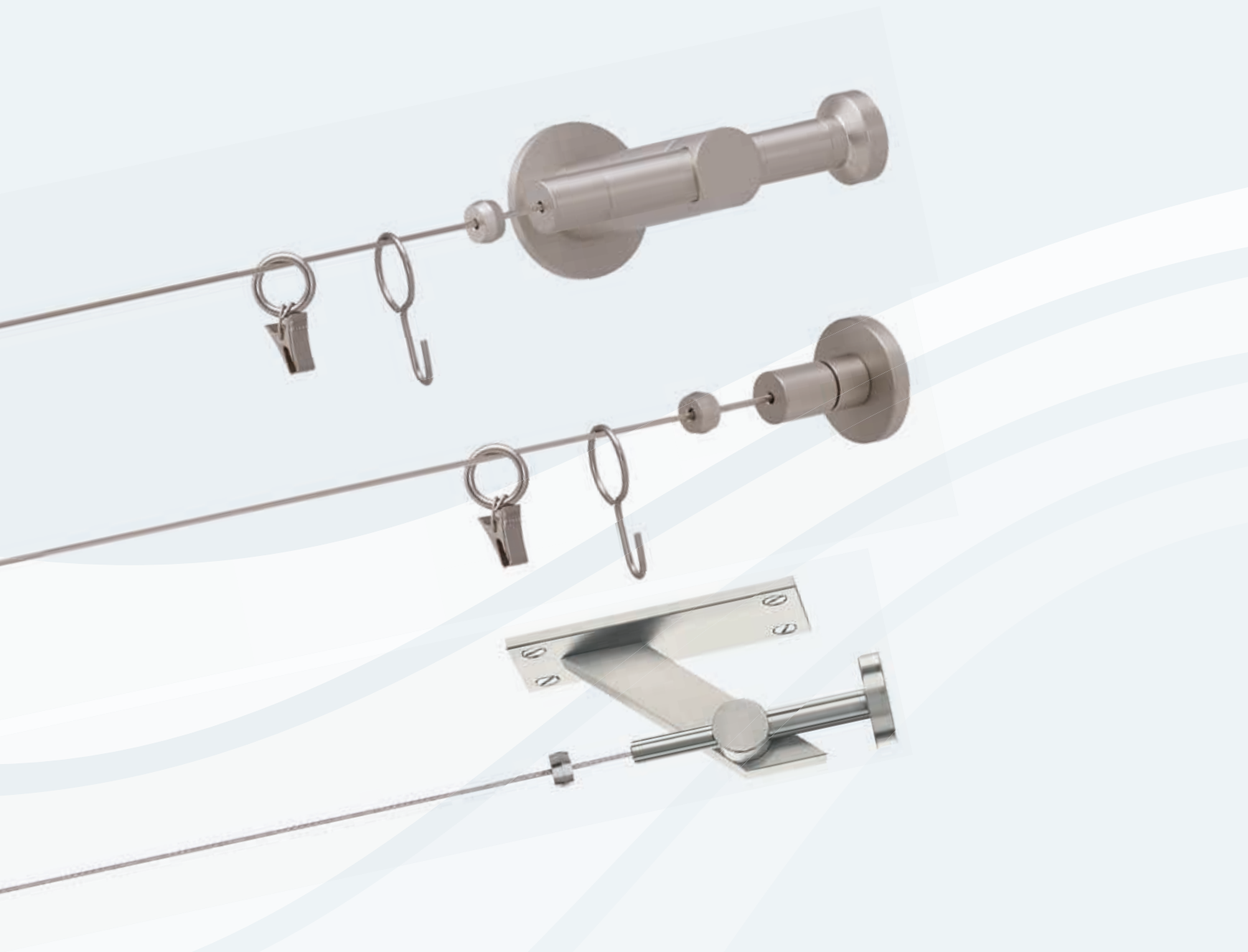

Spannsysteme

mit Ø5 mm Spannstange

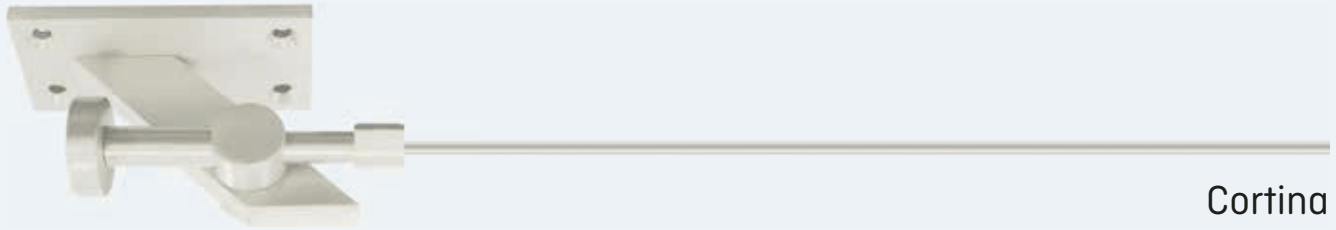

nickel matt

Cortina

Seite 351

Farben: 

mit Ø2 mm Spannseil



nickel matt

Cortina

Seite 351

Farben: 



nickel matt

Avellino

Seite 355

Farben: 



Cortina Ø5mm
Cortina Ø2mm

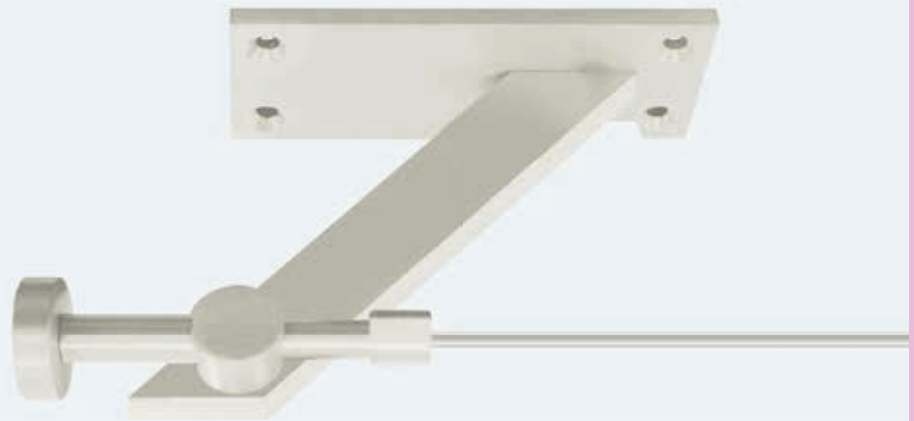

Cortina
mit Ø5mm Spannstange



Cortina
mit Ø2mm Spannseil

Cortina mit Spannstange



Abb. Wandabstand 40mm
nickel matt
Maßstab 1:1

Cortina mit Seil



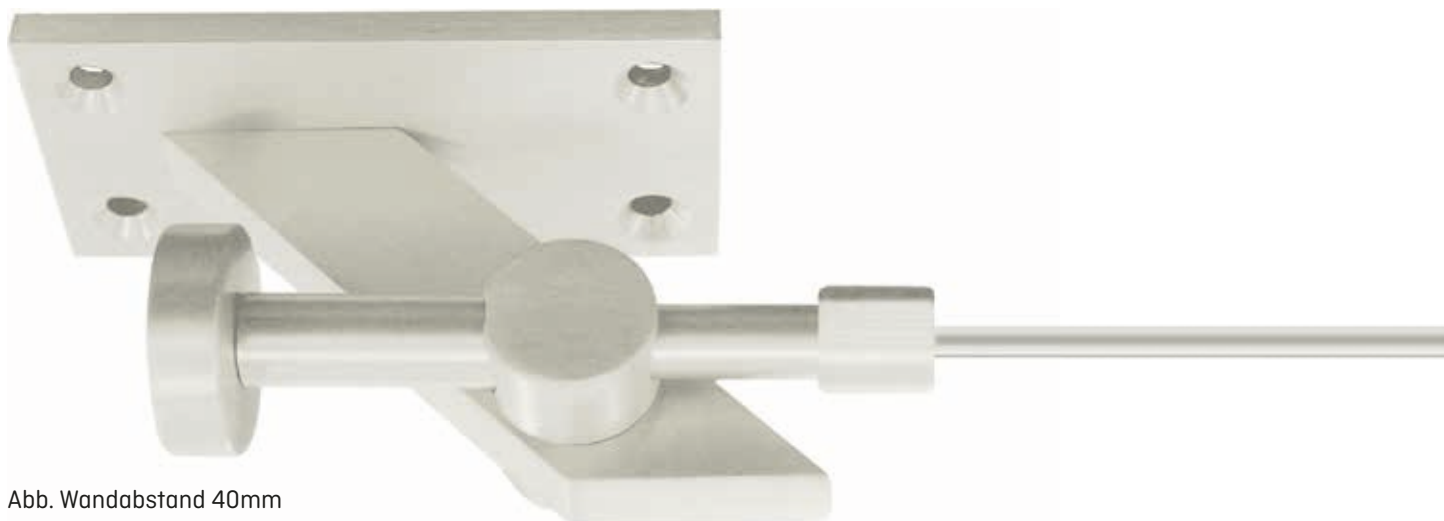

Abb. Wandabstand 40mm
nickel matt
Maßstab 1:1

Cortina mit Spannstange

Lieferumfang

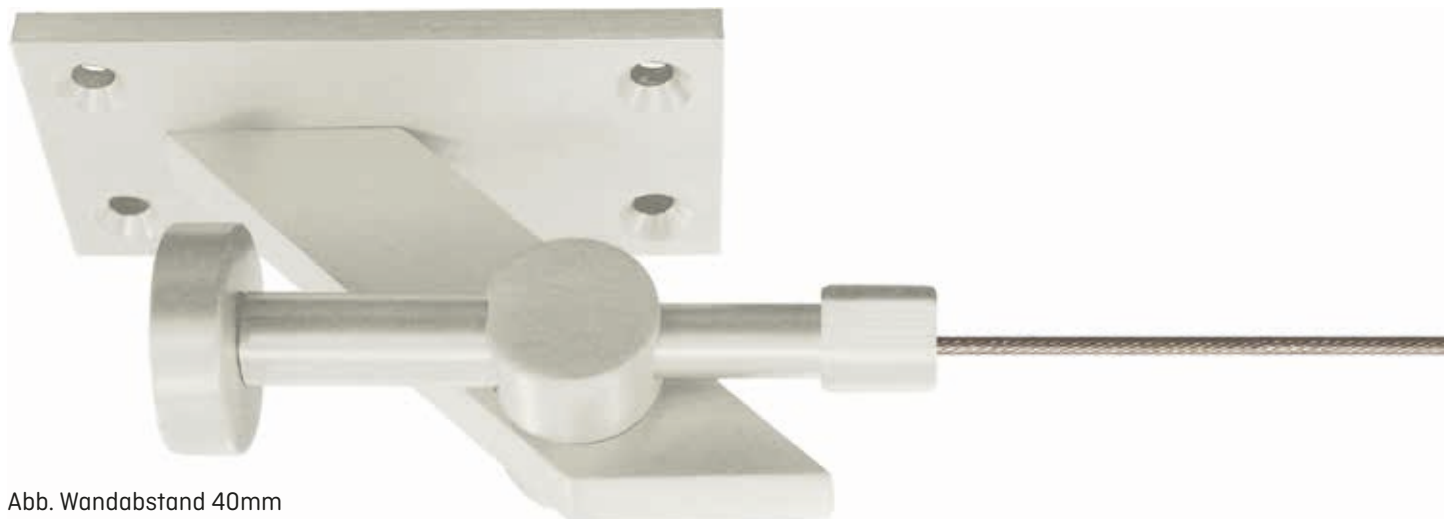
- ▶ **Cortina mit Spannstange 1 lfg:** 1 Edelstahlstange Ø5mm, je nach Länge Wand- bzw. Deckenträger lt. Liste
- ▶ Garniturpreise ohne Seilhaken!

- ▶ mit Montagematerial
- ▶ bei geänderter Ausführung Aufpreis bzw. Preisabschlag
- ▶ **Aus produktionstechnischen Gründen bestehen geringfügige Farbabweichungen zwischen den Karniesenkomponenten.**

		Länge (cm)																
Bestellcode ↓		200	220	240	260	280	300	320	340	360	380	400	420	440	460	480	500	
Wandträger		2	2	2	2	2	2	2	2	2	2	2	2	2	2	2	2	
Mittelträger		-	-	-	-	-	1	1	1	1	1	1	1	1	1	1	1	
	cor40n	1lfg/40mm	352	356	360	364	368	463	467	471	475	479	483	487	491	495	499	503
	cor80n	1lfg/80mm	373	377	381	385	389	490	494	498	502	506	510	514	518	522	526	530

Cortina mit Seil

Lieferumfang

- ▶ **Cortina mit Seil 1 lfg:** 5m Stahlseil rostfrei Ø2mm, 2 Wand- bzw. Deckenträger, 2 Seilfeststeller
- ▶ Garniturpreise ohne Seilhaken!

- ▶ mit Montagematerial
- ▶ bei geänderter Ausführung Aufpreis bzw. Preisabschlag
- ▶ **Aus produktionstechnischen Gründen bestehen geringfügige Farbabweichungen zwischen den Karniesenkomponenten.**

		Bestellcode	 nickel matt
			1-läufig
Nischenmontage		1cor-n	254,-
40mm Wandabstand		1cor-40n	286,-
80mm Wandabstand		1cor-80n	318,-

Cortina mit Spannstange

Wandträger/Deckenträger 1lfg - WA 40mm			Stück
	nickel matt	800 190 n	174,-

Wandträger/Deckenträger 1lfg - WA 80mm			Stück
	nickel matt	800 191 n	186,-

Wandlager			Stück
	nickel matt	800 47 n	126,-

Mittelträger 1lfg. Wandabstand 40mm			Stück
	nickel matt	800 193 n	102,-

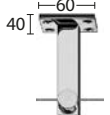
Mittelträger 1lfg. Wandabstand 80mm			Stück
	nickel matt	800 194 n	108,-

Edelstahlstange Ø5mm, Stange 5m			Meter
	edelstahl	es05	22,10

Seilhaken			Stück
	nickel matt	800 41n	1,40

Ring mit Clip			Stück
	nickel matt	800 42 n	3,60

Cortina mit Seil

Wandträger/Deckenträger 1lfg - WA 40mm			Stück
	nickel matt	800 111 n	138,-

Wandträger/Deckenträger 1lfg - WA 80mm			Stück
	nickel matt	800 119 n	156,-

Wandlager			Stück
	nickel matt	800 110 n	120,-

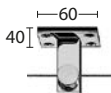
Mittelträger 1lfg. Wandabstand 40mm			Stück
	nickel matt	800 113 n	96,-

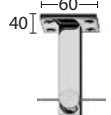
Mittelträger 1lfg. Wandabstand 80mm			Stück
	nickel matt	800 125 n	102,-

Seilfeststeller			Stück
	nickel matt	800 43 n	7,20

Stahlseil Ø2mm, 5m			Stück
	Stahl	8ds 205	28,80

Stahlseil Ø2mm, 10m			Stück
	Stahl	8ds 210	55,20

Seilhaken			Stück
	nickel matt	800 41 n	1,40

Ring mit Clip			Stück
	nickel matt	800 42 n	3,60



Avellino Ø2mm

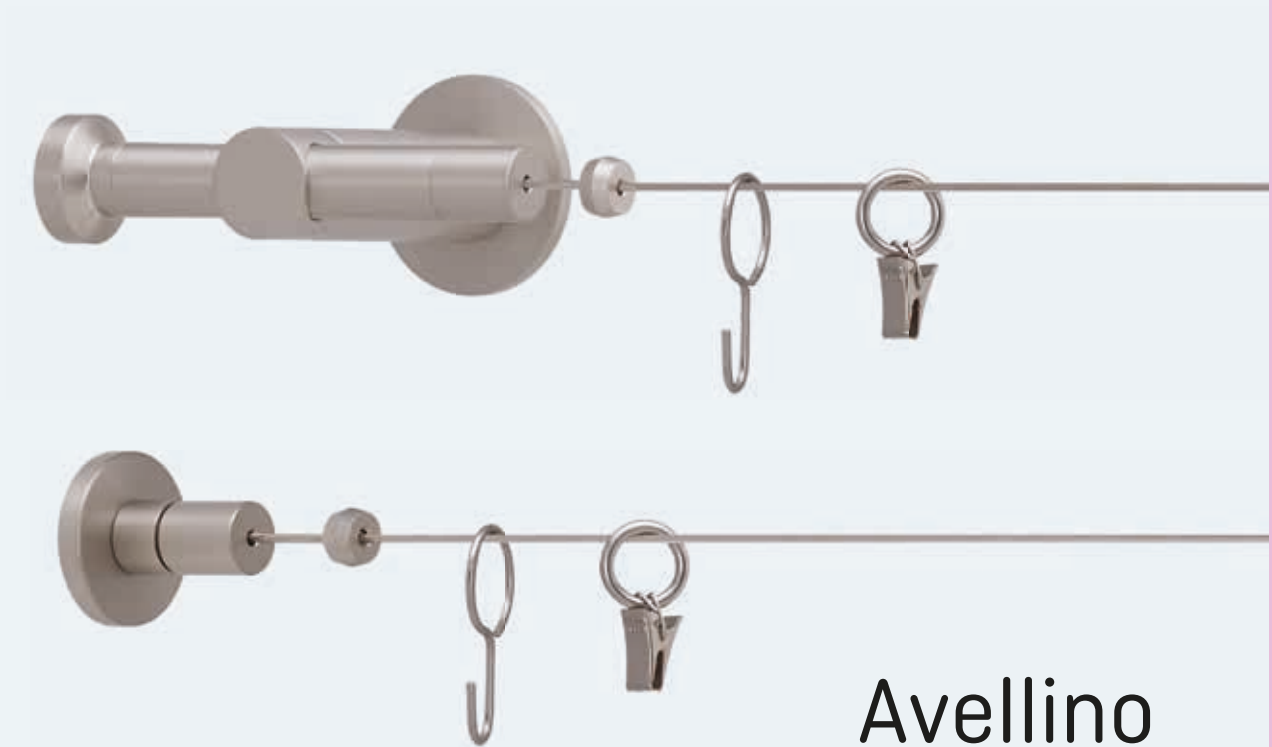

Avellino
mit Ø2mm Spannseil

Avellino



Abb. mit Wandträger für Wandmontage
80mm Wandabstand
nickel matt
Maßstab 1:1



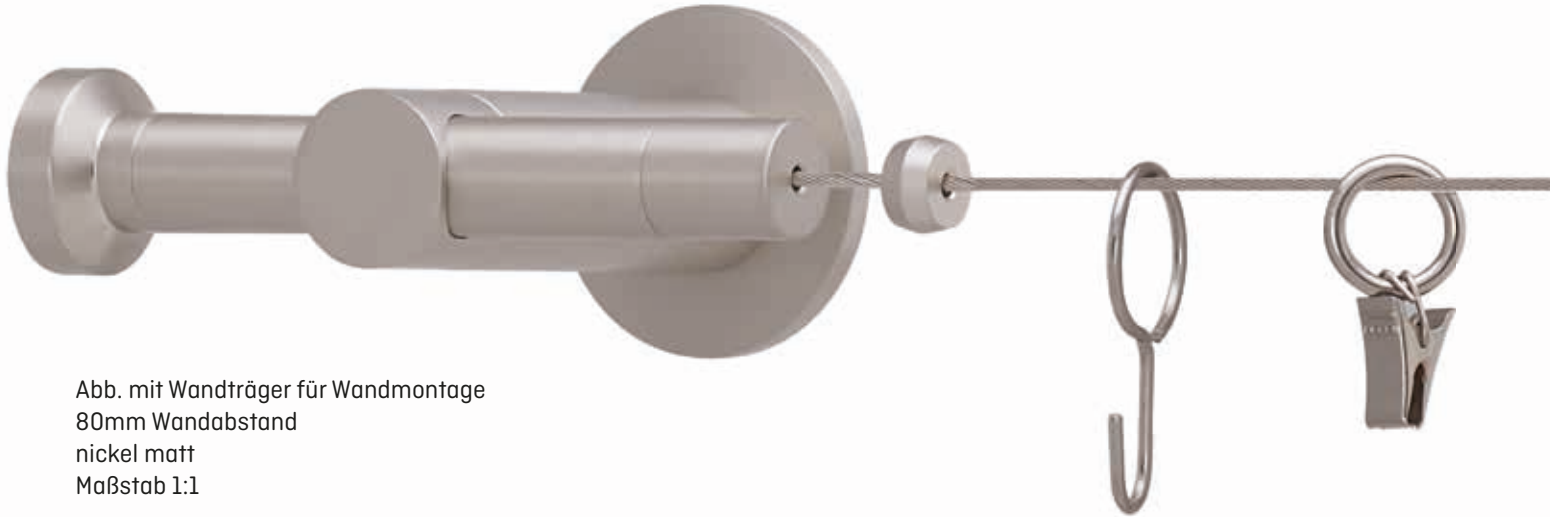

Abb. mit Wandhalter für Nischenmontage
nickel matt
Maßstab 1:1

Abb. Wandabstand 80mm
nickel matt
Maßstab 1:1

Avellino

Lieferumfang

- ▶ **1 lfg:** 5m Stahlseil rostfrei Ø2mm, 2 Wand- bzw. Deckenträger, 2 Seilfeststeller
 - ▶ Garniturpreise ohne Seilhaken!
-
- ▶ mit Montagematerial
 - ▶ bei geänderter Ausführung Aufpreis bzw. Preisabschlag
 - ▶ **Aus produktionstechnischen Gründen bestehen geringfügige Farbabweichungen zwischen den Karniesenkomponenten.**

		Bestellcode	 nickel matt
			1-läufig
80mm Wandabstand		1ave-80n	318,-
Nischenmontage		1ave-n	151,-

Wandträger/Deckenträger 1lfg - WA 80mm Stück

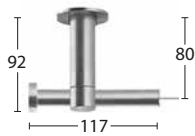

nickel matt 800 510 n 156,-

Mittelträger 1lfg. Wandabstand 80mm Stück



nickel matt 800 511 n 84,-

Wandlager Stück

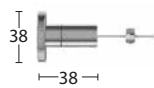

nickel matt 800 513 n 54,-

Seilhaken Stück



nickel matt 800 41 n 1,40

Ring mit Clip Stück



nickel matt 800 42 n 3,60

Seilfeststeller Stück



nickel matt 800 43 n 7,20

Stahlseil Ø2mm, 5m Stück



Stahl 8ds 205 28,80

Stahlseil Ø2mm, 10m Stück











Stahl 8ds 210 55,20



Vitragen

Vitragestangen

Angela	Ø7-9mm ausziehbar		Seite 362
Eveline	6x11mm ausziehbar		Seite 362
Nadine	Ø7mm ausziehbar		Seite 363
Barbara Reinmessing	Ø10mm ausziehbar		Seite 363
Alexandra Reinmessing	Ø10mm		Seite 364
Swarovski Reinmessing mit Swarovski-Kristall	Ø10mm		Seite 364
Sylvia	Ø12mm ausziehbar		Seite 365
Sydney Reinmessing	Ø13mm		Seite 366
Malta Reinmessing	Ø13mm		Seite 366

Angela	Ø7-9mm	
Eveline	6x11mm	
Nadine	Ø7mm	
Barbara	Ø10mm	
Alexandra	Ø10mm	
Swarovski	Ø10mm	
Sylvia	Ø12mm	
Sydney	Ø13mm	
Malta	Ø13mm	

Vitragenstangen

Angela Ø7-9mm



weiß

Lieferumfang

- ▶ 2 Stück Vitragenstangen inkl. Schraubhaken je Beutel
- ▶ Weiß: 50% Innenlänge

Länge (cm)	Ø in mm	Bestellcode	weiß
30	7	1ang03wf	2,-
40	7	1ang04wf	2,20
50	7	1ang05wf	2,40
60	7	1ang06wf	2,70
80	9	1ang08wf	4,70

Eveline 6x11mm



weiß
Maßstab 1:1

Lieferumfang

- ▶ 2 Stück Vitragenstangen mit Profil 6x11mm inkl. Schraubhaken je Beutel
- ▶ 100% Innenlänge

Länge (cm)	Bestellcode	weiß	Bestellcode	messing	Bestellcode	chrom matt
30	1eve03wf	2,70	1eve03mf	-	1eve03cm	-
40	1eve04wf	2,90	1eve04mf	3,70	1eve04cm	3,70
60	1eve06wf	3,70	1eve06mf	4,70	1eve06cm	4,70
80	1eve08wf	4,50	1eve08mf	5,80	1eve08cm	5,80
100	1eve10wf	5,30	1eve10mf	7,30	1eve10cm	7,30

Einzelteile

Schraubhaken				Selbstklebehaken			
			Stück				Stück
	vermessingt	6100 p	0,12		weiß	610 10wf	2,-
	vernickelt	6100 v	0,12		vermessingt	610 10mf	2,50
					verchromt	610 10cf	2,50
					chrom matt	610 10cm	2,50
					braun	610 10br	2,-

Nadine Ø7mm





poliert lackiert
Maßstab 1:1

Lieferumfang

- ▶ 1 Stück Reinmessingvitrage oberflächenbehandelt Ø7mm, inkl. Schraubhaken je Beutel
- ▶ 100% Innenlänge, kürzbar auf jedes gewünschte Maß ohne Aufpreis

Länge (cm)	Bestellcode	 poliert lackiert	Bestellcode	 verchromt	Bestellcode	 nickel matt	Bestellcode	 messing matt
60	1nad06p	10,90	1nad06v	15,40	1nad06n	19,10	1nad06m	12,60
100	1nad10p	17,80	1nad10v	23,50	1nad10n	29,60	1nad10m	20,50

Einzelteile

Schraubhaken				Selbstklebehaken			
			Stück				Stück
	vermessingt	6100 p	0,12		weiß	610 10wf	2,-
	vernickelt	6100 v	0,12		vermessingt	610 10mf	2,50
					verchromt	610 10cf	2,50
					chrom matt	610 10cm	2,50
					braun	610 10br	2,-

Barbara Ø10mm



nickel matt
Maßstab 1:1

Lieferumfang

- ▶ 1 Stück Reinmessingvitrage oberflächenbehandelt Ø10mm, inkl. Befestigungsmaterial je Beutel
- ▶ 30cm Innenlänge, kürzbar auf jedes gewünschte Maß ohne Aufpreis

Wandabstand zur Stangenmitte

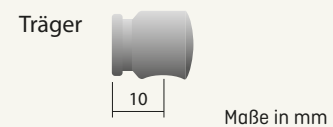

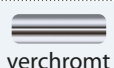
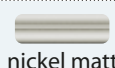
Länge (cm)	Bestellcode	 poliert lackiert	Bestellcode	 verchromt	Bestellcode	 nickel matt
60	1bar06p	39,70	1bar06v	52,10	1bar06n	52,10
80	1bar08p	42,80	1bar08v	56,50	1bar08n	56,50

Alexandra Ø10mm



poliert lackiert, Maßstab 1:1

Swarovski Ø10mm

solange der Vorrat reicht!



poliert lackiert, Maßstab 1:1

Lieferumfang

- ▶ 1 Reinmessingvitrage oberflächenbehandelt Ø10mm, je nach Länge Wandträger lt. Liste,
- 2 Endknöpfe
- ▶ Montagematerial

- ▶ Gesamtmaß „Alexandra“ = Rohrmaß + 2cm (mit beiden Endknöpfen)
- ▶ Gesamtmaß „Swarovski“ = Rohrmaß + 5cm (mit beiden Endknöpfen)
- ▶ bei geänderter Ausführung Aufpreis bzw. Preisabschlag
- ▶ **Aus produktionstechnischen Gründen bestehen geringfügige Farbabweichungen zwischen den Karniesenkomponenten.**

Wandabstand zur Stangenmitte



Maße in mm

		Alexandra			Swarovski		
		poliert lackiert	verchromt	nickel matt	poliert lackiert	verchromt	nickel matt
Bestellcode:		ale10p	ale10v	ale10n	swa10p	swa10v	swa10n
Länge (cm)	Wand-träger	1lfg	1lfg	1lfg	1lfg	1lfg	1lfg
40	2	49	69	79	102	113	116
60	2	53	75	86	106	119	123
80	2	57	81	93	110	125	130
100	2	61	87	100	114	131	137
120	2	65	93	107	118	137	144
140	3	78	111	124	136	156	165
160	3	82	117	131	140	162	172
180	3	86	123	138	144	168	179
200	3	90	129	145	148	174	186
+ 20cm	▲	4	6	7	4	6	7

Einzelteile

Endknopf Alexandra			Stück
	poliert lackiert	839 010p	12,60
	verchromt	839 010v	13,20
	nickel matt	839 010n	15,40

Endknopf Swarovski			Stück
	poliert lackiert	837 510p	37,75
	verchromt	837 510v	40,25
	nickel matt	837 510n	40,25

Wandträger			Stück
	poliert lackiert	816 010p	11,90
	verchromt	816 010v	13,20
	nickel matt	816 010n	15,60

Messingrohr Ø10mm, Stange 5m			Meter
	poliert lackiert	ms 1007p	34,-
	verchromt	ms 1007v	41,30
	nickel matt	ms 1007n	43,30

Sylvia Ø12mm

beide Knöpfe im
Lieferumfang enthalten

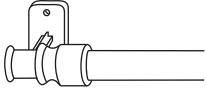

platzsparende Montage

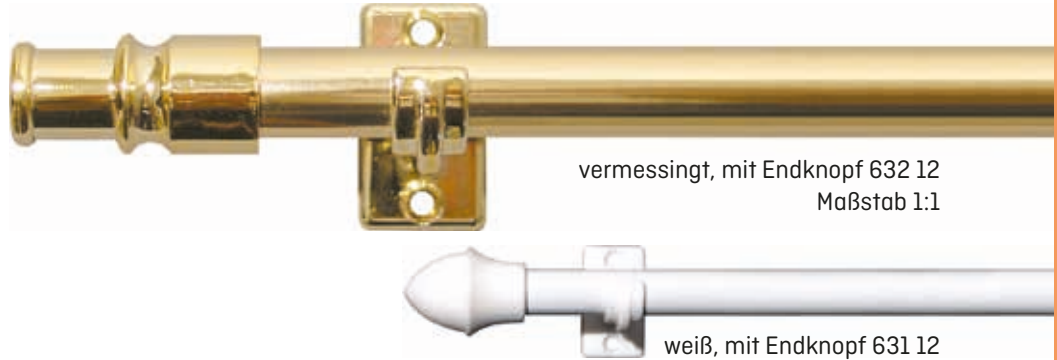

vermessingt, mit Endknopf 632 12
Maßstab 1:1

weiß, mit Endknopf 631 12

Lieferumfang

- ▶ 1 Metall-Vitragestange oberflächenbehandelt, ausziehbar, mit 2 kurzen und 2 langen Wandträgern, 2 Endknöpfe Art. 63112 und 2 Endknöpfe 63212, inkl. Befestigungsmaterial
- ▶ Wandträger zum Schrauben oder Kleben

Wandabstand zur Stangenmitte

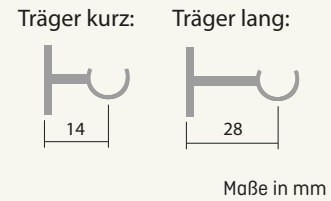

Länge (cm)	Bestellcode	weiß	Bestellcode	vermessingt	Bestellcode	verchromt	Bestellcode	chrom matt	Bestellcode	messing matt
55-85	1syl05wf	6,-	1syl05mf	8,80	1syl05cf	8,80	1syl05cm	8,80	1syl05mm	8,80
85-135	1syl08wf	7,60	1syl08mf	10,20	1syl08cf	10,20	1syl08cm	10,20	1syl08mm	10,20
135-225	1syl13wf	10,20	1syl13mf	13,60	1syl13cf	13,60	1syl13cm	13,60	1syl13mm	13,60

Einzelteile

Wandträger kurz - Wandabstand 14mm				Stück	Wandträger lang - Wandabstand 28mm				Stück
	weiß	615 12wf	1,50		weiß	616 12wf	1,50		
	messing	615 12mf	1,50		messing	616 12mf	1,50		
	chrom	615 12cf	1,50		chrom	616 12cf	1,50		
	chrom matt	615 12cm	1,50		chrom matt	616 12cm	1,50		
	messing matt	615 12mm	1,50		messing matt	616 12mm	1,50		

Sydney Ø13mm



poliert lackiert, Maßstab 1:1

Malta Ø13mm



verchromt, Maßstab 1:1

Lieferumfang

- ▶ 1 Reinnessingvitrage oberflächenbehandelt Ø13mm, je nach Länge Wandträger lt. Liste,
- 2 Endknöpfe
- ▶ Montagematerial

- ▶ Gesamtmaß „Sydney“ = Rohrmaß + 1,5cm (mit beiden Endknöpfen)
- ▶ Gesamtmaß „Malta“ = Rohrmaß + 4cm (mit beiden Endknöpfen)
- ▶ bei geänderter Ausführung Aufpreis bzw. Preisabschlag
- ▶ **Aus produktionstechnischen Gründen bestehen geringfügige Farbabweichungen zwischen den Karniesenkomponenten.**

Wandabstand zur Stangenmitte



Maße in mm

		Sydney			Malta		
		poliert lackiert	verchromt	nickel matt	poliert lackiert	verchromt	nickel matt
Bestellcode:		syd13p	syd13v	syd13n	mal13p	mal13v	mal13n
Länge (cm)	Wand-träger	1lfg	1lfg	1lfg	1lfg	1lfg	1lfg
100	2	96	118	119	110	131	132
120	2	100	124	125	114	137	138
140	2	104	130	131	118	143	144
160	3	133	164	165	147	177	178
180	3	137	170	171	151	183	184
200	3	141	176	177	155	189	190
+ 20cm	▲	4	6	6	4	6	6

Einzelteile

Endknopf Sydney			Stück
	poliert lackiert	831 312p	15,60
	verchromt	831 312v	18,70
	nickel matt	831 312n	20,70

Messingrohr Ø13mm, Stange 5m			Meter
	poliert lackiert	ms 1307p	31,-
	verchromt	ms 1307v	41,90
	nickel matt	ms 1307n	42,70

Endknopf Malta			Stück
	poliert lackiert	831 313p	19,50
	verchromt	831 313v	22,60
	nickel matt	831 313n	22,60

Ring Ø20mm + FH			Stück
	poliert lackiert	840 201 p	2,90
	verchromt	840 201 v	2,90
	nickel matt	840 201 n	2,90

Wandträger 1lfg - Wandabstand 35mm			Stück
	poliert lackiert	819 013p	25,80
	verchromt	819 013v	28,90
	nickel matt	819 013n	28,90

Faltenleghaken für Ring		Stück
	Kunststoff glasklar 36006 gk	0,10



Allgemeines Zubehör



Faltenleghaken

Seite 369



Gleiter, Laufroller, Gardinenhaken

Seite 369



Ringe

Seite 371



Raffrosetten, Raffknöpfe und Verlängerungen

Seite 373



Abstandhalter, Raffhalter

Seite 374



Stangen, Rohre, Innenlauf-Profile, Profilverbinder

Seite 375



Schleuderstäbe

Seite 377



Storeschienen

Seite 378



Biegungen

Seite 379



Erkerausmessanleitung

Seite 381

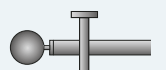

Bestellhilfe

Seite 383





Reinigung/Pflegehinweise

Seite 384

Faltenleghaken

Faltenleghaken				Stück
Öse				
	4mm	glasklar	36004 gk	0,10
	4mm	schwarz	36004 sf	0,10
	4mm	weiß	36004 wf	0,10
	5mm	glasklar	36006 gk	0,10
	6mm	glasklar	36006 gk	0,10
	6mm	schwarz	36006 sf	0,10
	6mm	weiß	36006 wf	0,10
	8mm	glasklar	36008 gk	0,10
	8mm	weiß	36008 wf	0,10
	10mm	glasklar	36010 gk	0,10
	10mm	weiß	36010 wf	0,10
	12mm	glasklar	36012 gk	0,10
12mm	weiß	36012 wf	0,10	

Faltenleghaken, für Flachringe				Stück
Öse				
	3mm	glasklar	36003 gk	0,10

Faltenleghaken				Stück
Öse				
	7mm	glasklar	36107 gk	0,17
	7mm	weiß	36107 wf	0,17

Faltenleghaken mit drehbarer Klammer				Stück
Öse				
	10mm	glasklar	36310 gk	1,-
	10mm	weiß	36310 wf	1,-

Gleiter, Laufroller, Gardinen-Haken

6mm-Schlitz

für Innenlauf-Profile 6mm-Schlitz

Ösengleiter 100 Stück

	Kunststoff weiß	3910 100	9,90
---	-----------------	----------	------

Ösengleiter mit Haken 100 Stück

	Kunststoff weiß	3911 100	13,-
---	-----------------	----------	------

Gleiter 100 Stück

	Kunststoff	3942 100	5,40
---	------------	----------	------

X-Gleiter mit Teflon 100 Stück

	Kunststoff	3943 100	5,90
---	------------	----------	------

Gleiter mit Faltenleghaken 100 Stück

	Kunststoff weiß	3914 100	6,-
---	-----------------	----------	-----

KLIXI-Drehgleiter 100 Stück

	Kunststoff weiß	2410 6100	11,-
---	-----------------	-----------	------

KLIXI-Drehgleiter mit Öse, Längsbügel 100 Stück

	Kunststoff weiß	2414 6100	11,-
---	-----------------	-----------	------

KLIXI-Drehgleiter mit Faltenleghaken 100 Stück

	Kunststoff grau	2400 100 g	12,-
	Kunststoff weiß	2400 100 w	12,-

KLIXI-Drehgleiter mit drehbarem FH

	Kunststoff weiß		
	einzel/Stück	24126	0,23
	100 Stück	2412 6100	19,-

KLIXI-Drehgleiter mit drehbarer Klammer

	Kunststoff weiß		
	einzel/Stück	24136	0,32
	100 Stück	2413 6100	28,-

Clic-Gleiter mit Haken kurz, 5,8-6,2mm

	Kunststoff weiß		
	einzel/Stück	3402	0,24
	100 Stück	3402 100	20,-

Clic-Gleiter mit Haken lang, 5,8-6,2mm

	Kunststoff weiß		
	einzel/Stück	3407	0,24
	100 Stück	3407 100	20,-

Roller mit Faltenleghaken, Kunststoff weiß

	Kunststoff weiß		
	einzel/Stück	2420	0,20
	100 Stück	2420 100	19,-

Roller mit Kugellager

	Kunststoff	904 074	1,10
	nur für Ø28 Innenlauf, Rechteck, Oval		



Gardinen-Einfachhaken 100 Stück

	Kunststoff weiß	601 100	6,50
---	-----------------	---------	------

Gleiter, Laufroller, Gardinen-Haken

6mm-Schlitz



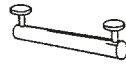









für Innenlauf-Profile 6mm-Schlitz

Gardinen-Doppelhaken 100 Stück				Beutel	Endfeststeller				Stück
	Kunststoff weiß	605 100	11,-		Kunststoff weiß	1349	0,40		
Zwischenfeststeller				Stück	Schlaufengleiter Kunststoff weiß				Stück
	Kunststoff weiß	1347	0,40		für 50mm Schlaufen	239 414	1,50		

Gleiter, Laufroller, Gardinen-Haken

4mm-Schlitz

für Innenlauf-Profile 4mm-Schlitz

Ösengleiter 100 Stück				Beutel	Clic-Gleiter mit Haken kurz, 3,6-4mm				
	Kunststoff weiß	2912 100	10,-		Kunststoff weiß einzel/Stück	3401	0,21		
Gleiter mit Faltenleglhaken 100 Stück				Beutel	100 Stück	3401 100	19,-		
	Kunststoff weiß	2913 100	11,-	Clic-Gleiter mit Haken kurz, 3,6-4mm					
	Kunststoff weiß einzel/Stück	3406	0,21						
100 Stück	3406 100	19,-							
KLIXI-Drehgleiter 100 Stück				Beutel	Gardinen-Einfachhaken 100 Stück				Beutel
	Kunststoff weiß	2410 4100	12,-		Kunststoff weiß	601 100	6,50		
KLIXI-Drehgleiter mit Faltenleglhaken 100 Stück				Beutel	Gardinen-Doppelhaken 100 Stück				Beutel
	Kunststoff weiß	2402 100	13,-		Kunststoff weiß	605 100	11,-		
KLIXI-Drehgleiter mit drehbarem FH					Zwischenfeststeller				Stück
	Kunststoff weiß einzel/Stück	2412 4	0,23		Kunststoff weiß	1355	0,40		
100 Stück	2412 4100	19,-		Endfeststeller				Stück	
KLIXI-Drehgleiter mit drehbarer Klammer						Kunststoff weiß	1348	0,40	
	Kunststoff weiß einzel/Stück	2413 4	0,32						
100 Stück	2413 4100	28,-							

Ringe

Messing-Ring Ø20mm + FH		Stück
	poliert lackiert	840 201 p 2,90
	verchromt	840 201 v 2,90
	nickel matt	840 201 n 2,90
	messaging matt	840 201 m 2,90

Messing-Ring Ø28mm + Faltenleghaken		Stück
	poliert lackiert	840 281 p 4,60
	verchromt	840 281 v 4,60
	nickel matt	840 281 n 4,60
	messaging matt	840 281 m 4,60

Ringe mit Kunststoffeinklebung

Messing-Ring Ø28mm mit Kunststoffeinklebung + FH		Stück
	poliert lackiert	842 281 p 4,90
	verchromt	842 281 v 4,90
	nickel matt	842 281 n 4,90
	messaging matt	842 281 m 4,90

Flachringe

Edelstahl-Flachring Ø20mm + FH		Stück
	edelstahl	847 201 e 2,-

Edelstahl-Flachring Ø28mm + FH		Stück
	edelstahl	847 281 e 2,80

Aluminium-Flachring Ø20mm + FH		Stück
	aluminium	847 201 a 2,-
	gold matt	847 201 gm 2,50
	schwarz matt	847 201 sm 2,20
	bronze matt	847 201 bm 2,50

Aluminium-Flachring Ø28mm + FH		Stück
	schwarz matt	847 281 sm 3,10
	bronze matt	847 281 bm 3,10
	weiß	847 281 w 3,10

Flachringe mit Kunststoffeinklebung für Messing und Aluminium

Messing-Flachring Ø20mm mit Kunst.einkl. + FH		Stück
	poliert lackiert	848 201 p 3,60
	verchromt	848 201 v 3,60
	nickel matt	848 201 n 3,60
	messaging matt	848 201 m 3,60
	bronziert	848 201 b 3,60

Messing-Flachring Ø28mm mit Kunst.einkl. + FH		Stück
	poliert lackiert	848 281 p 4,90
	verchromt	848 281 v 4,90
	nickel matt	848 281 n 4,90
	messaging matt	848 281 m 4,90

Aluminium-Flachring Ø20mm, Kunst.einkl. + FH		Stück
	aluminium	848 201 a 3,60
	schwarz matt	848 201 sm 3,60
	anthrazit	848 201 at 3,60
	rost	848 201 ro 3,60
	weiß	848 201 w 2,20

Aluminium-Flachring Ø28mm mit Kunst.einkl. + FH		Stück
	anthrazit	848 281 at 4,60

Iron Style

Ring Ø20mm + FH für Iron Style		Stück
	rostbraun	7411 rb 2,40
	weiß/gold	7411 wg 2,40
	schwarz	7411 sw 2,20

Holz-Ringe

Holz-Ring Ø20mm + FH		Stück	
	natur	740 201 na	0,65
	buche hell	740 201 bu	0,65
	kirschbaum	740 201 kr	0,65
	nussbaum	740 201 nu	0,65
	weiß	740 201 we	1,-
	schwarz	740 201 sw	1,-

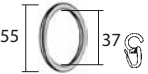
Holz-Ring Ø28mm + FH		Stück	
	natur	740 281 na	0,95
	buche hell	740 281 bu	0,95
	kirschbaum	740 281 kr	0,95
	nussbaum	740 281 nu	0,95
	weiß	740 281 we	1,30

Kunststoff-Ringe

solange der Vorrat reicht!

Kunststoff-Ring Ø20mm + FH		Stück	
	schwarz	7400 sf	0,80
	weiß	7400 wf	0,80

Haken und Ringe für Spannsysteme

Messing-Seilhaken		Stück	
	nickel matt	800 41 n	1,40

Messing-Ring mit Clip		Stück	
	nickel matt	800 42 n	3,60

Ringe für Modelle vor dem Jahr 2022

Preise und Verfügbarkeit auf Anfrage

Kunststoff-Ring Ø20mm + FH		
	schwarz	740 201 sf
	weiß	740 201 wf
	chrom matt	740 201 cm
	messing matt	740 201 mm
	chrom	740 201 cf
	messing	740 201 mf
	gold antik	740 201 ga
	graphit	740 201 gr
	bronze	740 201 br

Kunststoff-Ring Ø28mm + FH		
	chrom	740 281 cf
	messing	740 281 mf
	chrom matt	740 281 cm
	messing matt	740 281 mm
	weiß	740 281 wf

Holz-Ring Ø20mm + FH		
	natur gebleicht	740 201 na-a
	rotbuche	740 201 rbu

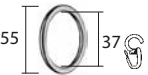
Holz-Ring Ø28mm + FH		
	natur gebleicht	740 281 na-a
	rotbuche	740 281 rbu
	eiche hell	740 281 eh
	eiche rustikal	740 281 er
	mahagoni	740 281 ma
	schwarz	740 281 sw

Rosette lose		Stück	
	poliert lackiert	8805 p	36,-
	messing matt	8805 m	36,-
	nickel matt	8805 n	36,-

Raffrosette komplett, Wandabstand 80mm		Stück	
	anthrazit	8618 at	40,80

Raffrosette komplett, Wandabstand 80mm		Stück	
	poliert lackiert	8806 p	43,20
	messing matt	8806 m	43,20
	nickel matt	8806 n	43,20

Raffknopf komplett, Wandabstand 80mm		Stück	
	aluminium	86 418 a	33,60
	gold matt	86 418 gm	40,80
	schwarz matt	86 418 sm	33,60
	bronze matt	86 418 bm	40,80
	edelstahl	86 418 e	33,60

Rosette lose		Stück	
	poliert lackiert	8828 p	19,80

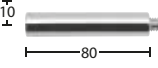
Verlängerung 80mm		Stück	
	aluminium	88 028 a	10,80
	gold matt	88 028 gm	14,40
	schwarz matt	88 028 sm	10,80
	bronze matt	88 028 bm	14,40
	edelstahl	88 028 e	10,80

Raffrosette komplett, Wandabstand 80mm		Stück	
	poliert lackiert	8829 p	45,-

Rosette lose		Stück	
	poliert lackiert	8807 p	36,-
	messing matt	8807 m	36,-
	nickel matt	8807 n	36,-

Raffrosette komplett, Wandabstand 80mm		Stück	
	poliert lackiert	8808 p	43,20
	messing matt	8808 m	43,20
	nickel matt	8808 n	43,20

Verlängerung 80mm		Stück	
	poliert lackiert	88 027 p	16,80
	messing matt	88 027 m	16,80
	nickel matt	88 027 n	16,80

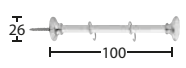
Abstandhalter, Wandabstand 100mm		Stück	
	poliert lackiert	860 610 p	21,60
	verchromt	860 610 v	21,60
	messing matt	860 610 m	21,60
	nickel matt	860 610 n	21,60
	weiß	860 610 w	21,60

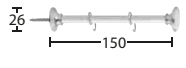
Abstandhalter, Wandabstand 150mm		Stück	
	poliert lackiert	860 615 p	24,-
	verchromt	860 615 v	24,-
	messing matt	860 615 m	24,-
	nickel matt	860 615 n	24,-
	weiß	860 615 w	24,-

Raffhalter, Wandabstand 110mm		Stück	
	poliert lackiert	860 816 p	96,-
	verchromt	860 816 v	108,-
	messing matt	860 816 m	96,-
	nickel matt	860 816 n	108,-
	bronziert	860 816 b	108,-

Raffhalter, Wandabstand 160mm		Stück	
	poliert lackiert	860 820 p	102,-
	verchromt	860 820 v	114,-
	messing matt	860 820 m	102,-
	nickel matt	860 820 n	114,-
	bronziert	860 820 b	114,-

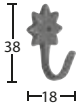
Rosettenhaken		Stück	
	poliert	865 538 p	3,-

Rosettenhaken		Stück	
	poliert	865 040 p	3,-
	bronziert	865 040 b	3,-
	nickel matt	865 040 n	3,-

Rosettenhaken		Stück	
	poliert	865 050 p	3,20

Haken mit Schraube		Stück	
	poliert lackiert	868 25 p	3,84
	verchromt	868 25 v	3,84
	weiß	868 25 w	3,84
	messing matt	868 25 m	3,84
	nickel matt	868 25 n	3,84
	bronziert	868 25 b	3,84

Haken mit Schraube		Stück	
	poliert lackiert	868 31 p	4,44
	weiß	868 31 w	4,44
	messing matt	868 31 m	4,44
	nickel matt	868 31 n	4,44

Haken mit Schraube		Stück	
	poliert	868 51 p	3,60

Haken		Stück	
	poliert	866 030 p	3,-
	vernickelt	866 030 v	3,-
	messing matt	866 030 m	3,-
	weiß	866 030 w	3,-
	nickel matt	866 030 n	3,-

Messingrohr Ø10mm, Stange 5m Meter

	poliert lackiert	ms 1007p	34,-
	verchromt	ms 1007v	41,30
	nickel matt	ms 1007n	43,30

Edelstahlrohr, Ø12mm, Stange 6m Meter

	edelstahl	es 1210	35,50
---	-----------	---------	-------

Eisenrohr messingummantelt Ø13mm, Stange 5m Meter

	poliert lackiert	ms 1307p	31,-
	verchromt	ms 1307v	41,90
	nickel matt	ms 1307n	42,70

Alu Innenlauf-Profilrohr Ø16mm, Stange 6m Meter

	poliert lackiert	n90 616 p	58,-
	nickel matt	n90 616 n	58,-
	messing matt	n90 616 m	58,-
	edelstahl	n90 616 e	35,90

Edelstahlrohr, Ø16mm, Stange 6m Meter

	edelstahl	es 1610	24,80
---	-----------	---------	-------

Messingrohr, Ø16mm, Stange 5m Meter

	poliert lackiert	ms 1607 p	50,40
	nickel matt	ms 1607 n	50,40
	messing matt	ms 1607 m	50,40

Alu Innenlauf-Profilrohr Ø20mm, Stange 6m Meter

	poliert lackiert	n90 620 p	63,50
	verchromt	n90 620 v	63,50
	nickel matt	n90 620 n	63,50
	messing matt	n90 620 m	63,50
	edelstahl	n90 620 e	41,40
	buche	n90 620 bu	41,40
	wildeiche	n90 620 wi	41,40
	zwetschke	n90 620 zw	41,40
	aluminium	n90 620 a	38,60
	aluminium matt	n90 620 am	41,40
	gold matt	n90 620 gm	38,60
	schwarz matt	n90 620 sm	38,60
	bronze matt	n90 620 bm	38,60
	rost	n90 620 ro	49,70
	anthrazit	n90 620 at	49,70
	schwarz struktur	n90 620 ss	38,60
weiß	n90 620 w	38,60	
weiß struktur	n90 620 ws	38,60	

Edelstahlrohr, Ø20mm, Stange 6m Meter

	edelstahl	es 2010	27,60
---	-----------	---------	-------

Aluminium-Rohr, Ø20mm, Stange 6m Meter

	aluminium	al 20 a	27,60
	gold matt	al 20 gm	27,60
	schwarz matt	al 20 sm	27,60
	bronze matt	al 20 bm	27,60
	rost	al 20 ro	45,50
	anthrazit	al 20 at	45,50
	weiß	al 20 w	27,60

Messingrohr, Ø20mm, Stange 5m Meter

	poliert lackiert	ms 2006 p	57,60
	verchromt	ms 2006 v	57,60
	nickel matt	ms 2006 n	57,60
	messing matt	ms 2006 m	57,60

Stahlrohr, Ø20mm, Stange ca. 3m Meter

	rostbraun	sr 20 rb	48,50
	weiß/gold	sr 20 wg	48,50
	schwarz	sr 20 sw	48,50

Alu Innenlauf-Profilrohr Ø28mm, Stange 6m Meter

	poliert lackiert	n90 628 p	81,40
	verchromt	n90 628 v	81,40
	nickel matt	n90 628 n	81,40
	messing matt	n90 628 m	81,40
	edelstahl	n90 628 e	55,20
	schwarz matt	n90 628 sm	52,40
	bronze matt	n90 628 bm	52,40
	wildeiche	n90 628 wi	55,20
	zwetschke	n90 628 zw	55,20
	weiß	n90 628 w	52,40
	weiß struktur	n90 628 ws	52,40
	schwarz struktur	n90 628 ss	52,40
	anthrazit	n90 628 at	58,-

Edelstahlrohr, Ø28mm, Stange 6m Meter

	edelstahl	es 2810	45,50
--	-----------	---------	-------

Aluminiumrohr, Ø28mm, Stange 6m Meter

	schwarz matt	al 28 sm	45,50
	bronze matt	al 28 bm	45,50
	anthrazit	al 28 at	52,40
	weiß	al 28 w	45,50

Messingrohr, Ø28mm, Stange 5m Meter

	poliert lackiert	ms 2810 p	74,70
	verchromt	ms 2810 v	74,70
	nickel matt	ms 2810 n	74,70
	messing matt	ms 2810 m	74,70

Profilverbinder Messing, beliebiger Winkel Stück

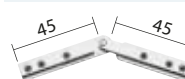
	vernickelt	904 072 - bw	28,80
--	------------	--------------	-------

Profilverbinder Messing Stück

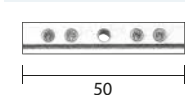
	vernickelt	904 071	12,-
--	------------	---------	------

Rohrverbinder Metall verzinkt Stück

	Ø16mm	1716	13,20
	Ø20mm	1720	14,40
	Ø28mm	1728	15,60

Holzstangen

Holzstange Ø20mm, Stange ca. 4,2m			Meter
	natur	sk201 na	17,90
	nussbaum	sk201 nu	17,90
	buche hell	sk201 bu	17,90
	kirschbaum	sk201 kr	17,90
	weiß	sk201 we	17,90
	schwarz	sk201 sw	17,90

Holzstange Ø28mm, Stange ca. 4,2m			Meter
	natur	sk281 na	18,30
	buche hell	sk281 bu	18,30
	kirschbaum	sk281 kr	18,30
	nussbaum	sk281 nu	18,30
	weiß	sk281 we	18,30

Schleuderstäbe

Schleuderstab mit Griff, Messing massiv

Stück

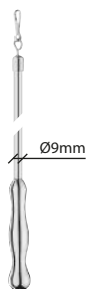

Stab Ø9mm

75cm

poliert lackiert	173 075 p	74,40
nickel matt	173 075 n	86,40

100cm

poliert lackiert	174 100 p	84,-
nickel matt	174 100 n	96,-

125cm

poliert lackiert	173 125 p	93,60
nickel matt	173 125 n	105,60

Schleuderstab, Aluminium

Stück



100cm

aluminium	171 100 a	43,20
gold matt	171 100 gm	43,20
bronze matt	171 100 bm	43,20
schwarz matt	171 100 sm	43,20
weiß	171 100 we	43,20

125cm

aluminium	171 125 a	48,-
gold matt	171 125 gm	48,-
bronze matt	171 125 bm	48,-
schwarz matt	171 125 sm	48,-
weiß	171 125 we	48,-

150cm

aluminium	171 150 a	52,80
gold matt	171 150 gm	52,80
bronze matt	171 150 bm	52,80
schwarz matt	171 150 sm	52,80
weiß	171 150 we	52,80

Schleuderstab, Acryl glasklar

Stück



100cm	170 100	3,20
125cm	170 125	5,-
150cm	170 150	6,60

Schleuderstab, Edelstahl

Stück



Stab Ø10mm

100cm

edelstahl	171 100 e	43,20
-----------	-----------	-------

125cm

edelstahl	171 125 e	48,-
-----------	-----------	------

150cm

edelstahl	171 150 e	52,80
-----------	-----------	-------

200cm kürzbar

edelstahl	171 200 e	77,50
-----------	-----------	-------

Schleuderstab, Stahl mit Kunststoffüberzug, weiß

Stück



100cm	175 100	4,-
125cm	175 125	5,-
150cm	175 150	5,50

Storeschienen



Lieferumfang

- ▶ Aluminium Innenlauf-Profil oberflächenbehandelt mit Liftschleuse
- ▶ je nach Länge Kunststoff-Schielenhalter und Gleiter lt. Liste, 2 Endkappen Metall vernickelt oder Kunststoff weiß
- ▶ bei geänderter Ausführung Aufpreis bzw. Preisabschlag
- ▶ **Aus produktionstechnischen Gründen bestehen geringfügige Farbabweichungen zwischen den Karniesenkomponenten.**

Innenlauf-Profil

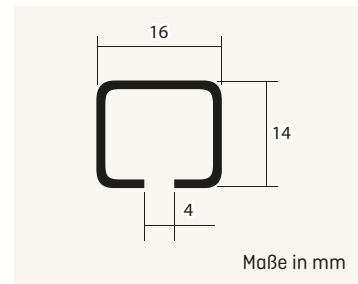

Bestellcode:	zs2p	zs2v	zs2n	zs2m	zs2cm	zs2be	zs2br	zs2we
Länge (cm)	Schielenhalter	Gleiter						
100	2	16	26	26	26	26	26	26
120	2	18	28	28	28	28	28	28
140	2	22	30	30	30	30	30	30
160	2	26	32	32	32	32	32	32
180	2	28	34	34	34	34	34	34
200	2	32	36	36	36	36	36	36
220	3	34	37	37	37	37	37	37
240	3	38	39	39	39	39	39	39
260	3	42	41	41	41	41	41	41
280	3	44	43	43	43	43	43	43
300	3	48	45	45	45	45	45	45
320	3	50	47	47	47	47	47	47
340	3	54	49	49	49	49	49	49
360	3	58	51	51	51	51	51	51
380	3	60	53	53	53	53	53	53
400	4	64	59	59	59	59	59	59
+ 20 cm ▲		3	2	2	2	2	2	2
Preisabschlag ohne Liftschleuse			1,-	1,-	1,-	1,-	1,-	1,-

U-Schielenhalter Stück



Kunststoff transparent

751 gk

2,-

U-Schielenhalter für Ø15-30mm Stück



Kunststoff transparent

749 gk

2,-

Endkappe Stück



Metall vernickelt
Kunststoff weiß

1351 vn
1356 wf

3,60
4,20

Liftstab Stück



bis Raumhöhe ca. 260cm
bis Raumhöhe ca. 300cm

4031 a
4032 a

60,-
70,-

Faltensteckgleiter für Liftstab, 100 Stück Beutel



Kunststoff weiß

2403 100

4,-

Biegungen für Erker

HINWEIS: nicht alle Farben sind biegsam.

Tabelle BIEGBARKEIT von Innenlauf-Profil in verschiedenen Farben siehe nächste Seite

90° Biegung

horizontale Biegung

Spezialbiegungen und
Dachschrägen
auf Anfrage!



Pro Winkel und Schiene:

63,-

beliebiger Winkel

horizontale Biegung

Spezialbiegungen und
Dachschrägen
auf Anfrage!

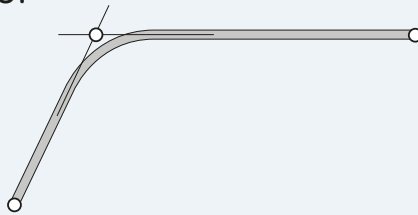

Pro Winkel und Schiene:

68,-

beliebiger Winkel

horizontale Biegung

Spezialbiegungen und
Dachschrägen
auf Anfrage!

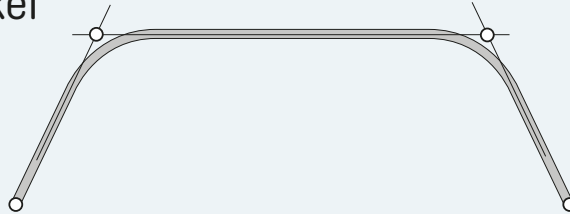

Pro Winkel und Schiene:

68,- je Biegung

Rundbogen (Kreissegment-Bogen)

horizontale Biegung

Spezialbiegungen und
Dachschrägen
auf Anfrage!



wird lt. Radius oder Schablone gebogen
min. Radius ca. 150cm (profilabhängig)

165,- / Laufschiene

- Bei Erkerausführungen können je nach Gegebenheit zusätzliche Träger erforderlich sein (Abhängig u.a. vom Durchmesser der Stange, Beschaffenheit der Mauer, mögliche Kippeffekte).
- Zusätzliche Träger sind auf den Garniturpreis aufzurechnen!

ÜBERSICHT: BIEGBARKEIT DER INNENLAUF-PROFILE

	p	v	m	n	e	a	gm	sm	bm	bu	we	zw	am	w	at	ro	ws	ss	pg	gg

max. 90°-Biegung möglich!

Farbcode:

Aluminium-Innenlauf-Profil

Ø16mm	Biegeradius: 20 cm																			
Ø20mm	Biegeradius: 20 cm																			
Ø28mm	Biegeradius: 30 cm																			
Profilmarnituren																				
Quadrat 20x20	Biegeradius: 30 cm																			
Eckig 34x14	Biegeradius: 20 cm																			
Rechteck 40x15	Biegeradius: 30 cm																			

Reinmessing-Rundrohre nur mit Gelenkverbinder möglich! ○ Rundbogen auf Anfrage

Aluminium-Rundrohre nur mit Gelenkverbinder möglich! ○ Rundbogen auf Anfrage

Hinweis: Biegungen sind materialabhängige Vorgänge! Es kann von Charge zu Charge vorkommen, dass sich Rohre, die als biegsam gelten, aufgrund anderer Materialeigenschaften (Legierungen, Oberflächenbehandlungen, Lackierungen) nicht mehr biegen lassen.

Teilung: Innenlauf-Rohre werden wenn möglich im Ganzen gebogen. Sollte das nicht möglich sein oder eine Teilung gewünscht sein, bitte den dafür erforderlichen Profilverbinder bestellen. Für die optimale Stabilität des Karniesensystems empfehlen wir die Rohr-Teilung immer bei der Trägermitte vorzunehmen.

Erker Ausmessanleitung

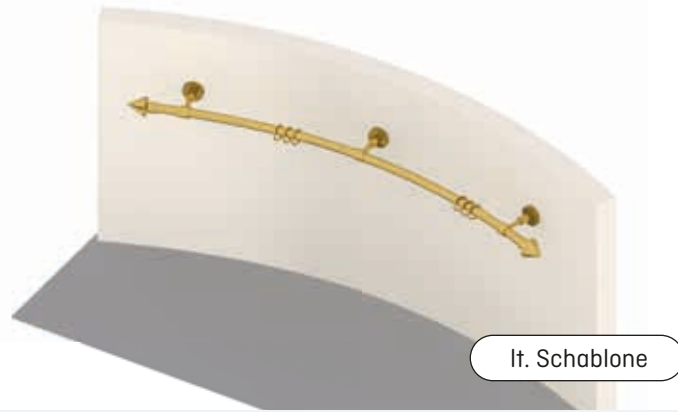
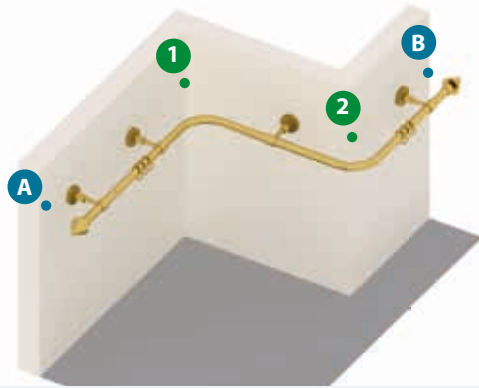

Erker 1 mit Winkel 90°

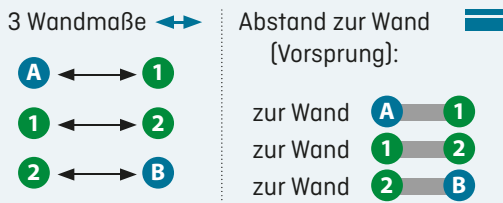

Erker 2 Rundbogen

Die Anfertigung dieser Erkerkarniese ist nur lt. Vorlage einer Schablone bzw. einem Radius möglich:

- Kartonschablone mit abgebildeter Wandrundung
- Abstand der Vorhanggarnitur (Vorsprung) zur Wand angeben

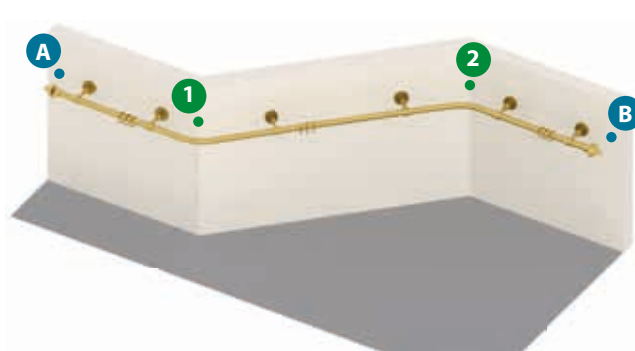
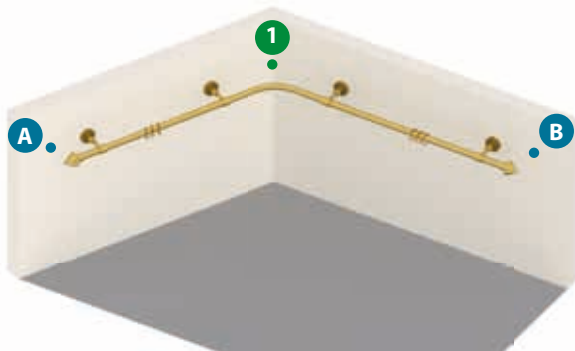

Erker 3 beliebiger Winkel mit 1 Bogen



Erker 4 beliebiger Winkel mit 2 Bögen

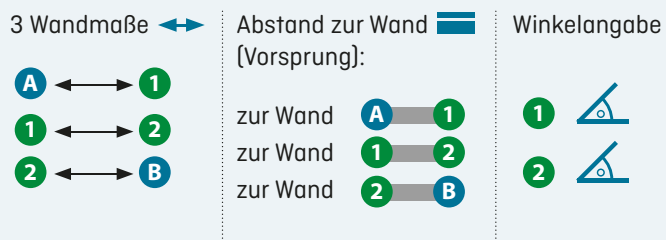

Abstand zur Wand (Vorsprung) ≡

Generell richtet sich der gewünschte Wandabstand nach den Wandabständen des bestellten Trägersystems. Viele Wand- bzw. Deckenträger lassen sich kürzen (siehe Abschnitt „Träger kürzen“ auf den Garniturpreis-Seiten) oder verlängern (siehe Einzelteilseite des jeweiligen Trägersystems).

Bei Trägerverlängerungen bzw. schwereren Vorhängen wird für Wandträger eine Trägerstütze empfohlen (siehe Einzelteile jeweiliges Trägersystem).

Die eingezeichneten Träger in den Erkerskizzen hängen stark von den Naturmaßen ab, und können eventuell nicht wie abgebildet gesetzt werden. Je nach Gegebenheit kann ein zusätzlicher Träger erforderlich sein (Abhängig u.a. vom Durchmesser der Stange, Beschaffenheit der Mauer, mögliche Kippeffekte). Sollten diese/er Träger nicht im Garniturpreis enthalten sein, (siehe Länge = Trägeranzahl des jeweiligen Trägersystems), so sind/ist diese/er auf den Garniturpreis aufzurechnen!

Erker Ausmessanleitung

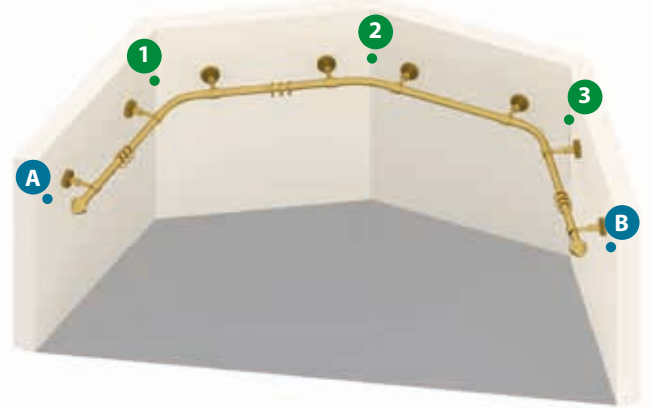
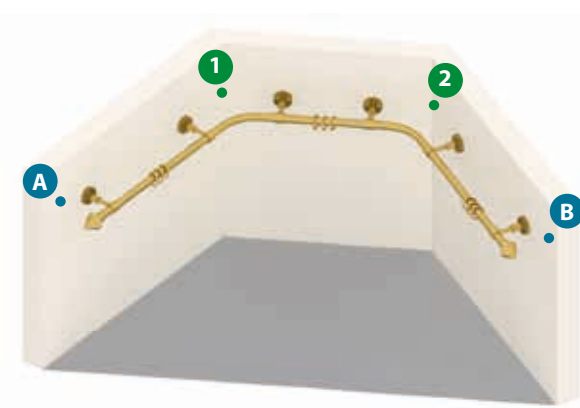

Erker 5 beliebiger Winkel mit 2 Bögen



Erker 6 beliebiger Winkel mit 3 Bögen

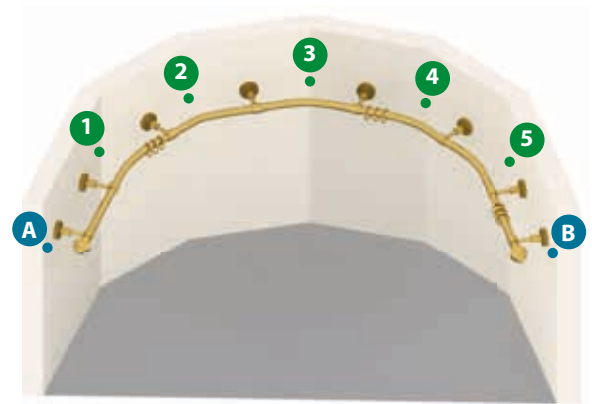
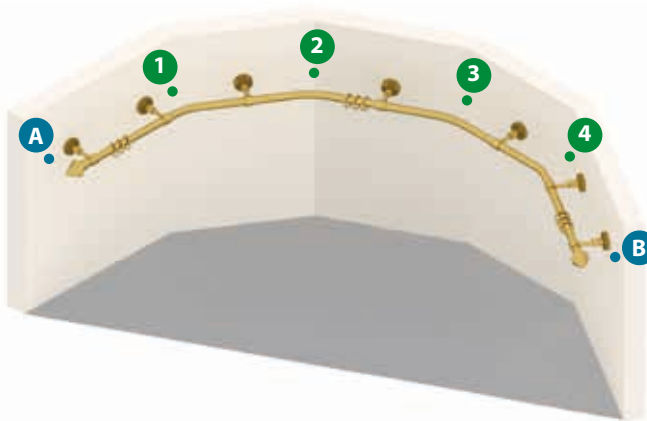
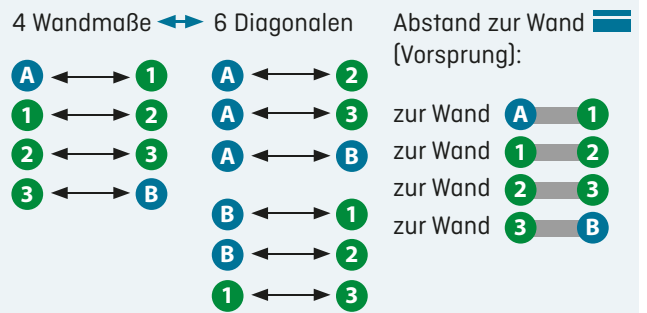

Erker 7 beliebiger Winkel mit 4 Bögen



Erker 8 beliebiger Winkel mit 5 Bögen



Vorhanggarnituren - Maßbezeichnungen

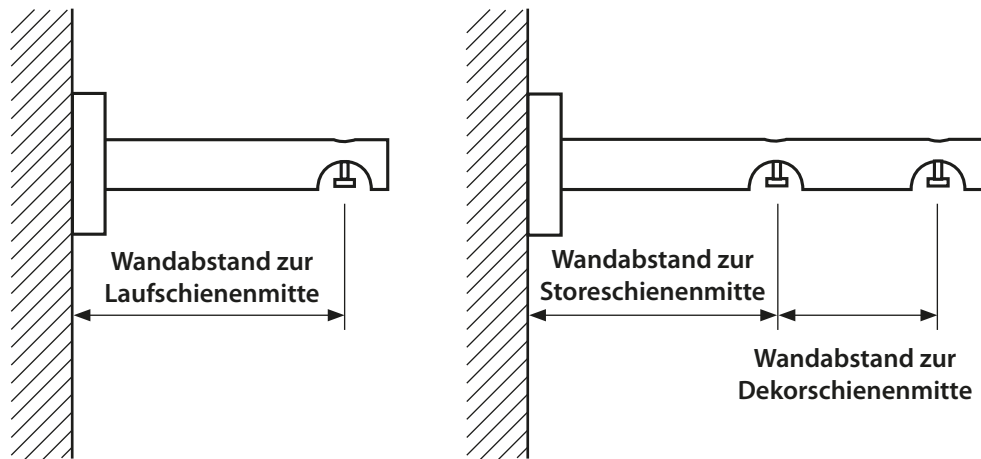

Beidseitig Endknöpfe

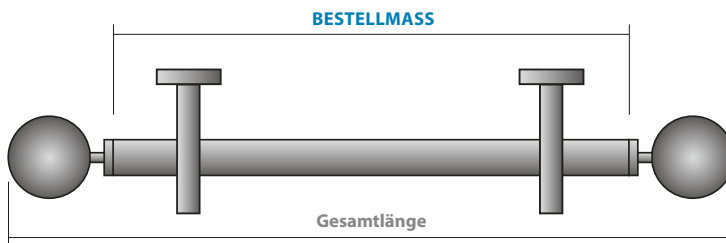

Benötigte Angaben:

- Artikelnummer Trägersystem
- Artikelnummer Endknöpfe
- Bestellmaß = Stangenlänge in cm
OHNE Endknöpfe

ACHTUNG: sollte die Gesamtlänge gewünscht sein so muss in der Bestellung **Gesamtlänge inkl. Endknöpfe** angeführt werden.

Einseitig Wandlager

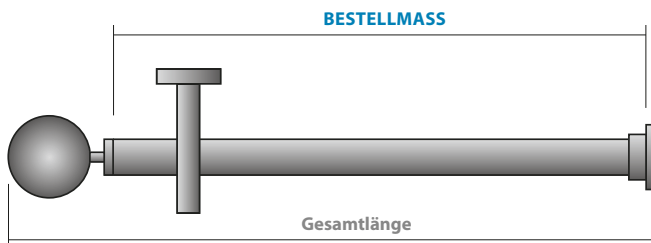

Wandlager: Sollte die Stange seitlich in die Mauer einlaufen, so wird ein Wandlager benötigt.

Benötigte Angaben:

- Artikelnummer Trägersystem
- Artikelnummer Endknopf
- Bestellmaß = Stangenlänge in cm
OHNE Endkopf und OHNE Wandlager

ACHTUNG: sollte die Gesamtlänge gewünscht sein so muss in der Bestellung **Gesamtlänge inkl. Endknopf + Wandlager** angeführt werden.

Beidseitig Wandlager

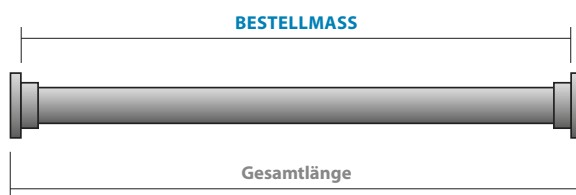

Wandlager: Sollte die Stange beidseitig in die Mauer einlaufen, so werden zwei Wandlager benötigt.

Benötigte Angaben:

- Artikelnummer Trägersystem
- Bestellmaß = Stangenlänge in cm
OHNE Wandlager

ACHTUNG: sollte die Gesamtlänge gewünscht sein so muss in der Bestellung **Gesamtlänge inkl. Wandlager** angeführt werden.

Reinigung/Pflegehinweise

Staubablagerungen beeinträchtigen die Lauf- bzw. Gleitfähigkeit von Ringen, Gleitern und Rollern. Beim Bedienen von verschmutzten Vorhanggarnituren kann die Stangen- bzw. Innenlauf-Profiloberfläche zerkratzt werden.

REINIGUNG

Mittels einem feuchtem Tuch die Oberfläche reinigen, danach wenn möglich mit einem Mikrofasertuch bzw. einem feinem, trockenen Tuch nachwischen.



NIEMALS Scheuermittel oder Polituren zur Reinigung verwenden, da damit die Oberflächenbeschichtung beschädigt werden kann!

VERBESSERUNG DER LAUF-/GLEITEIGENSCHAFT:

• Bei Innenlauf-Profilen mit Gleiter oder Laufroller

Unsere Gleitsprays erhöhen die Laufeigenschaften der Gleiter und verringert die Geräuschentwicklung beim Bedienen der Vorhänge. Sprühen Sie den Gleitspray in den Schienenlauf, die Anwendung ist bei Bedarf zu wiederholen.

Ab Werk werden unsere Innenlauf-Profile vorsilikonisiert geliefert, zur regelmäßigen Erneuerung der Gleiteigenschaften empfehlen wir diese Produkte:

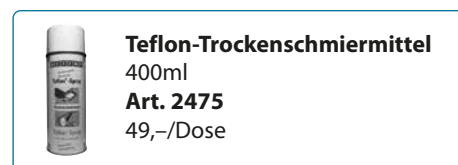
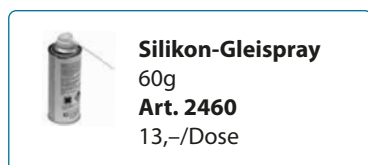

• Bei Stangen mit Ringen

Bei Verwendung von Ringen mit Kunststoffeinlage werden die Gleiteigenschaften wesentlich verbessert und die Geräuschentwicklung gedämpft.

Korrekte Anbringung von Faltenleghaken

WICHTIG!!! Die Faltenleghaken müssen korrekt in das Vorhangband eingesetzt werden, da ansonsten optimale Gleit-/Laufeigenschaften der Gleiter bzw. Roller nicht gegeben sind. Es sollten nicht mehr als 16 Gleiter/Roller je Laufmeter verwendet werden, da sonst die Gleit-/Laufeigenschaften verschlechtert werden.

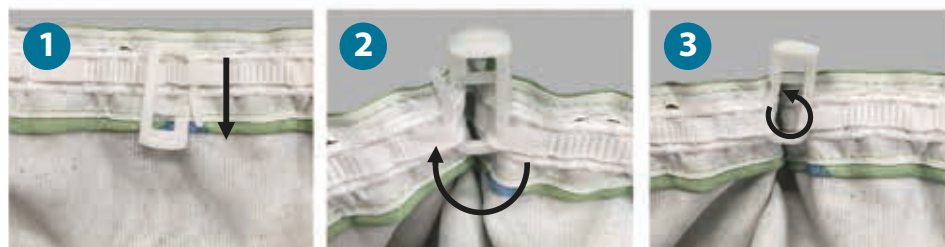

Montageanleitungen

Montageanleitungen zu jedem Produkt finden Sie auf unserer Website unter:
<http://www.flix.at/downloads/montageanleitungen>



Die Preisliste ist ab 2022 gültig und ersetzt alle bisherigen Verkaufspreislisten.

Alle angegebenen Preise verstehen sich als unverbindlich empfohlene Verkaufspreise inkl. MwSt.
Der Katalog „Flix Vorhanggarnituren“ ist urheberrechtlich geschützt.
Der Nachdruck, komplett oder auszugsweise ist nur nach Genehmigung durch FLIX erlaubt.

Materialkombinationen: Aufgrund unterschiedlicher Materialien und Fertigungstechniken können Farbabweichungen auftreten.

Druck- und Satzfehler, technische Änderungen und Irrtümer vorbehalten.

Für den Inhalt verantwortlich: FLIX Karniesen und Sonnenschutz GmbH & Co KG, Hauptstraße 16, 2231 Strasshof

Grafikdesign und Layout: Christoph Letmaier, Michaela Schamp

www.flix.at

FLIX Karniesen und Sonnenschutz GmbH & Co KG

Hauptstraße 16, 2231 Strasshof
Telefon: 02287 / 34 07, Fax: 02287 / 34 07 - 20

E-Mail: office@flix.at

Florianigasse 44, 1080 Wien
Telefon: 01 / 402 07 07, Fax: 01 / 405 70 90